



HI981520
Marine Monitor
pH, Marine Salinity, and Temperature



Method and Parameter

Chosen parameter and method used is displayed along with the reading.

Dedicated Setup Key

A dedicated setup key allows users to quickly navigate to setup options.

Splash-proof Keypad

Intuitive on-screen menus are easy to navigate with the splash-proof keypad.

Power Supply

The 12 Vdc adapter (included) allows for continuous monitoring.

BNC pH Probe Connection

Fixed EC probe

Built-in temperature sensor at the tip of the EC sensor allows for rapid determination of the sample temperature and a high-accuracy temperature reading.



Compact size

Measures 125 mm (4.92") x 185 mm (7.28") and only 38 mm (1.49") thick.

Dedicated Calibration Key

A dedicated calibration key allows users to start a one or two-point pH and EC automatic calibration at the touch of a button.

Fixed EC probe cable

Replaceable pH probe with BNC connection

The PEI resin body is easy to clean and resistant to many aggressive chemicals.

The porous PTFE junction is equally resistant to aggressive chemicals.

The double junction design presents a silver-free electrolyte solution interacting with the sample, making the electrode less susceptible to clogging and guaranteeing a fast response and stable reading.



HI981520

Marine Monitor pH, Marine Salinity and Temperature

Testing and monitoring salinity in saltwater aquariums is an ongoing task.

The HI981520 is an easy to use vertical mount unit that continuously monitors and displays conductivity and pH.

The system can be calibrated at one or two points for pH and at one point for conductivity.

Seawater salinity is expressed in either parts per thousand (ppt), Practical Salinity Units (PSU), or Specific Gravity (S.G.).

A high/low alarm can be configured for each parameter and the results are displayed on a large, easy to read LCD.

The attached two-electrode conductivity probe features a built-in temperature sensor for rapid, high-accuracy temperature readings.

The Hanna HI1286 pH double junction, gel-filled pH electrode features a PEI resin body that is easy to clean and resistant to many aggressive chemicals. Additionally, the double junction design is less susceptible to clogging for fast and stable readings.

- Waterproof
- Automatic temperature compensation (ATC)
- Dual pin graphite EC probe



Features



Backlit LCD

Easy to read backlit LCD display with the option to change LCD color from the setup menu

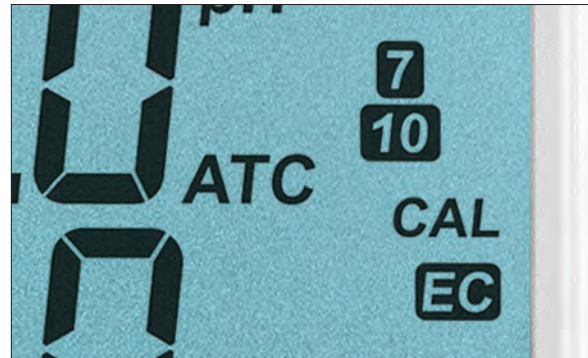

Automatic Calibration

A one or two-point pH calibration can be performed using one of the two standard buffer solutions: 7.01 or 10.01pH.

A one-point conductivity calibration can be performed using 35.00 ppt salinity standard solution.

CAL Tags display in measurement mode after a calibration has been performed for visual reminder.

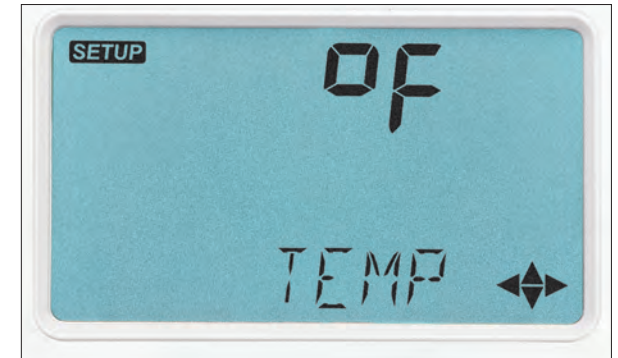

Automatic Temperature Compensation

All readings are compensated for variations in temperature and can be displayed with temperature values in °C or °F. Choose °C or °F measurement through the setup menu.

High/Low Alarms

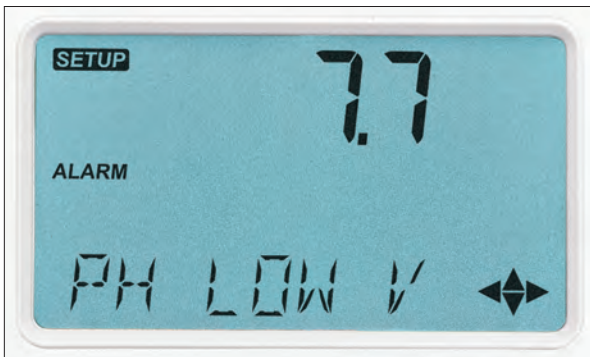

Alarm Setup

High/Low alarms can be set for each supported parameter (or can be disabled) quickly through the setup menu.

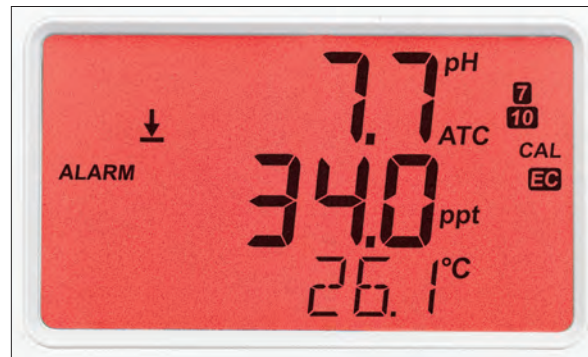

Alarm State

Alarms are generated when measured value exceeds or drops below configured parameter High/Low Value.



Optional Acoustic Alarm

An acoustic signal can be generated each time an alarm is triggered and can be silenced at the touch of a button. Enable or disable this feature easily through the setup menu.

Seawater Salinity

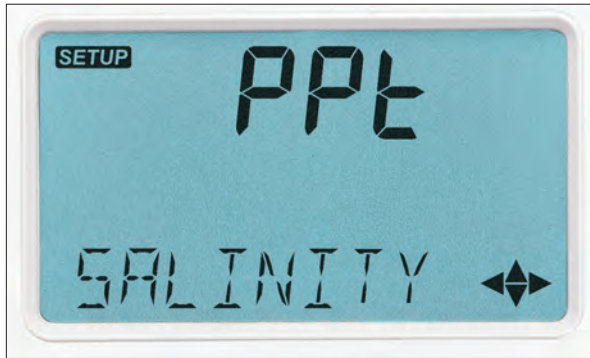

Choice of Units

Seawater salinity units can be chosen through the setup menu.



PSU

The practical salinity of seawater relates the ratio of electrical conductivity of a normal seawater sample at 15 °C and 1 atmosphere to a potassium chloride solution (KCl) with a mass of 32.4356 g/Kg water at the same temperature and pressure. Under these conditions the ratio is equal to 1 and S=35. The practical salinity scale may be applied to values 0 through 42.00 psu at temperatures between 0 to 35 °C.

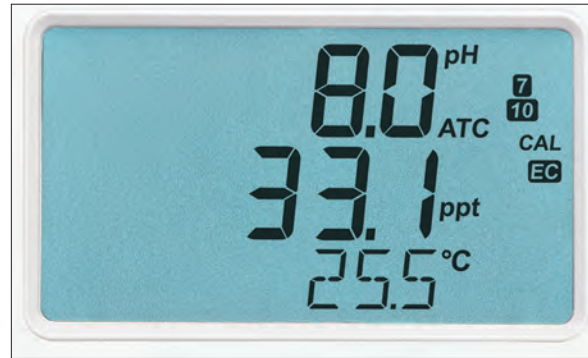

ppt

Measurements expressed in ppt are based on the Natural Seawater Scale that extends from 0.00 to 80.00 g/L and covers 10 to 31 °C temperature range. It determines the salinity based upon a conductivity ratio of sample to standard seawater at 15 °C and an approximate salinity value of 35 in seawater.



Specific Gravity (S.G.)

Specific Gravity, or relative density, is expressed as the ratio of the density of seawater, at a specific temperature, relative to the density of the same volume of pure water at a specific temperature.

The probes are secured with suction cups to the back of an aquarium (tank) and are suited for continuous measurement of conductivity and associated parameters required in applications such as seawater, saltwater aquariums, or aquaculture.

Installation

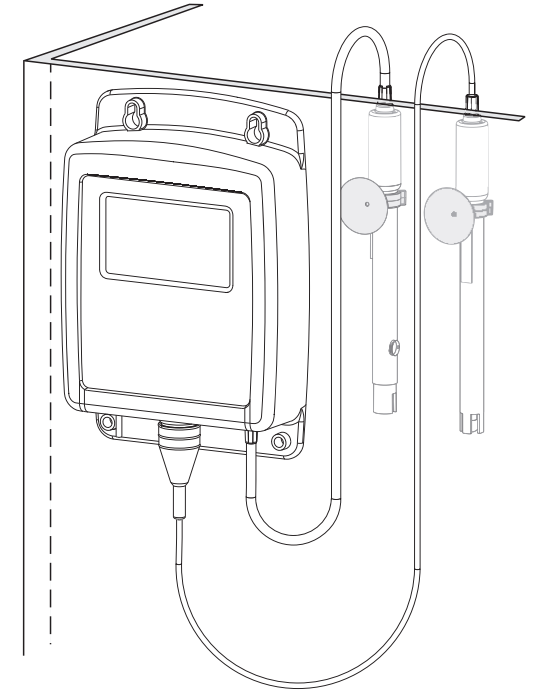

Supplied Option

The probes can be installed/immersed directly in a tank or aquarium (with supplied suction cups) and are suited for continuous measurement of conductivity and associated parameters required in applications such as seawater, saltwater aquariums, or aquaculture. Each probe features a 2 m (6.6') cable length for extended distances between monitor and sample.

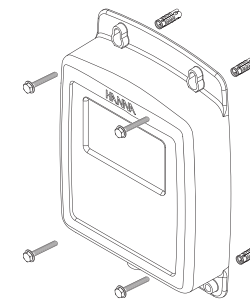

User Supplied Option

Alternatively, the monitor can be secured using the screw mount option (user supplied hardware).

HI981520 Specifications

| | | |
|---------------------------|--|--|
| pH | Range* | 0.0 to 14.0 pH |
| | Resolution | 0.1 pH |
| | Accuracy | ±0.2 pH |
| | Calibration | Manual or automatic two-point calibration in 7.01 and 10.01 pH |
| ppt | Range | 0.0 to 70.0 ppt (g/L) |
| | Resolution | 0.1 ppt (g/L) |
| | Accuracy | ±1.0 ppt between 0.0 ppt and 40.0 ppt ±2.0 ppt between 40.0 ppt and 70.0 ppt |
| | Calibration | Automatic, single point in 35.00 ppt |
| PSU | Range | 0.0 to 70.0 PSU |
| | Resolution | 0.1 PSU |
| | Accuracy | ±1.0 PSU between 0.0 and 40.0 PSU ±2.0 PSU between 40.0 and 70.0 PSU |
| S.G. | Range | 1.000 to 1.041 S.G. |
| | Resolution | 0.001 S.G. |
| | Accuracy | ±0.001 S.G. |
| Temperature | Range | 0.0 to 50.0 °C (32.0 to 122.0 °F) |
| | Resolution | 0.1 °C / 0.1 °F |
| | Accuracy | ±0.5 °C / ±1.0 °F |
| | Compensation | Automatic, 5 to 50 °C (41 to 122 °F) |
| Alarm | pH | High or Low with Enable or Disable option |
| | EC | High or Low with Enable or Disable option |
| | Temperature | High or Low with Enable or Disable option |
| High/Low Value | | with High/Low alarm Enabled |
| Probes | pH | HI1286 |
| | EC | Attached |
| Power Supply | | 12 Vdc adapter (included) from 115 Vac, and 230 Vac |
| Environment | | 0 to 50°C (32 to 122°F); RH max 95%, non-condensing |
| Casing | | IP65 ingress protection |
| Dimensions | | 125 x 185 x 38 mm (4.92 x 7.28 x 1.49") |
| Weight | | 300 g (10.6 oz) |
| Ordering Information | | HI981520 Marine Monitor is supplied with HI1286 pH electrode; attached EC and temperature probe; pH 7.01 buffer solution, 20 mL sachet (2 pcs.); pH 10.01 buffer solution, 20 mL sachet (2 pcs.); 35.00 ppt salinity calibration solution, 20 mL sachet (2 pcs.); electrode cleaning solution, 20 mL sachet (2 pcs.); suction cup with clip (2 pcs.); self-adhesive fastener (2 pcs.); 12 Vdc power adapter; quick reference guide with QR code for manual download and instrument quality certificate. |
| Solutions and Accessories | | HI1286 Double junction pH electrode with 2 m (6.6') cable |
| | | HI70007P pH 7.01 solution, 20 mL sachet (25 pcs.) |
| | | HI7007M pH 7.01 solution, 230 mL bottle |
| | | HI70010P pH 10.01 solution, 20 mL sachet (25 pcs.) |
| | | HI7010M pH 10.01 solution, 230 mL bottle |
| | | HI70024M 35.00 ppt salinity calibration solution, 230 mL bottle |
| | | HI70024P 35.00 ppt salinity calibration solution, 20 mL sachet (25 pcs.) |
| | | HI70300M Storage solution for pH electrodes, 230 mL bottle |
| | HI700601P General purpose cleaning solution, 20 mL sachet (25 pcs.) | |
| | HI7061M Cleaning solution for pH electrodes, 230 mL bottle | |

* The range may be limited by the probe's limits.

HI1286 pH Probe Specifications

| | |
|-----------------------------------|----------------------------|
| Range | 0 to 13 pH |
| Recommended operating temperature | 0 to 80 °C (32 to 176 °F) |
| Body | PEI |
| Junction | PTFE |
| Reference | Double junction, Ag/AgCl |
| Electrolyte | Polymer |
| Tip | Spheric / Ø 7.5 mm (0.29") |
| Outer Diameter | 12 mm (0.47") |
| Overall Length | 160 mm (6.29") |
| Maximum pressure | 3 bar (44 psi) |
| Cable | Coaxial, 2 m (6.56') |
| Connection | BNC |



EC and Temperature Probe Specifications

| | |
|-----------------------------------|---|
| Range | 0.0 to 70.0 ppt 0.0 to 70.0 PSU 1.000 to 1.041 S.G. |
| Recommended operating temperature | 0 to 50 °C (32 to 122 °F) |
| Body | Polypropylene (PP) |
| Conductivity sensor | Material: ABS Electrode: Graphite |
| Temperature sensor | AISI 316 stainless steel |
| Outer Diameter | 12.50 mm (0.49") |
| Overall length | 155 mm (6.10") |
| Maximum pressure | 3 bar (44 psi) |
| Cable type/length | Coaxial / 2 m (6.56') |
| Connection | Fixed (to the monitor) |



www.hannainst.com