

PUE HX7

WEIGHING INDICATOR

USER MANUAL

ITKU-107-07-07-20-EN











RADWAG® RADWAG BALANCES AND SCALES
ADVANCED WEIGHING TECHNOLOGIES

JULY 2020

PRECAUTIONS

Prior to installation, use or maintenance activities, carefully read this user manual. Use the PUE HX7 Indicator only as intended.

	Prior to the first use, carefully read this user manual. Use the device only as intended.
	Protect the indicator against considerable temperature variation, solar and UV radiation, substances causing chemical reactions.
	The HX7 indicator must not be operated in hazardous areas endangered with explosion of gases, and in dusty environments.
	In case of damage, immediately unplug the device from the mains.
	Scales to be decommissioned must be decommissioned in accordance with valid legal regulations.
	Do not let battery discharge in case of prolonged storage of the device in low temperature.
	A worn out battery can be replaced only by the manufacturer or by the authorized service.
	Accumulators do not belong to regular household waste. The European legislation requires discharged accumulators to be collected and disposed separately from other communal waste with the aim of being recycled. Symbols on batteries identify harmful compounds: Pb = lead, Cd = cadmium, Hg = mercury. Dear user, you are obliged to dispose of the worn out batteries as regulated.

Contents

1. INTENDED USE	5
2. WARRANTY CONDITIONS	5
3. MAINTENANCE ACTIVITIES	6
3.1. Cleaning Stainless Steel Components	6
3.2. Cleaning ABS Components	6
4. MECHANICAL DESIGN	7
4.1. Dimensions	7
4.2. Connectors Arrangement	8
4.3. Pins Arrangement	9
4.4. Inputs / Outputs	10
4.4.1. Technical Specifications	10
4.4.2. I/O Schematic Diagrams	11
4.5. Operation Panel	11
4.6. Technical Specification	12
5. INDICATOR INSTALLATION	13
5.1. Unpacking and Installation	13
5.2. Start-Up	13
5.3. Battery Status	13
6. HOME SCREEN	14
6.1. Top Bar	14
6.2. Weighing Result Window	15
6.3. Workspace	15
6.4. Pictograms	15
7. OPERATING THE MENU	16
7.1. Entering the Menu	16
7.2. Menu Keys	16
7.3. Entering Numbers / Text	17
7.3.1. Numerical Box	17
7.3.2. Text Box	19
7.3.3. Diacritical Sign Table	20
7.3.4. Special Sign Table	21
7.4. Return to Weighing	21
8. INSTALLER INSTRUCTION	22
8.1. Connecting 6-Wire Load Cell	22
8.2. Connecting 4-Wire Load Cell	23
8.3. Connecting Load Cell's Cable Shield	23
9. FACTORY SETUP	24
9.1. Factory Setup Access	24
9.2. Global Parameters	25
9.3. Factory Parameters	26
9.4. Return to Weighing	28
9.5. Scale Defining	28
9.6. Factory Adjustment	29
9.6.1. External Adjustment	29
9.6.2. Start Mass Determination	29
9.7. Linearity Correction	30
9.7.1. Linearity Determination	30
9.7.2. Corrections	30
9.7.3. Deleting Linearity	31
9.8. Gravitational Coefficient	31
10. OPTIONAL EXTENSION MODULES	32
10.1. Additional 12IN/12OUT Module	32
10.2. AN analog output module	34
10.3. Additional Platform Module, DP6	35
10.4. PROFIBUS Module	37
11. DIAGRAMS OF CONNECTION CABLES	38
12. ERROR MESSAGES	40

1. INTENDED USE

PUE HX7 weighing indicator is a device intended to make industrial scales operating on the basis of load cells. It is equipped with a stainless steel housing of high IP. The PUE HX7 features 7" colour display guaranteeing perfect readability, and a diode bar graph visualising MIN, MAX thresholds. It is operated using 22-key membrane keypad equipped with programmable function keys.

PUE HX7 indicator of standard design offers RS232, USB type A, Ethernet, 4 I/O interfaces. Optionally it can be equipped with an internal battery, this allows its operation in places where there is no access to the mains. The device integrates with receipt and label printers, barcode scanners and PC accessories (mouse, keyboard, USB flash drive).

2. WARRANTY CONDITIONS

- A. RADWAG feels obliged to repair or exchange all elements that appear to be faulty by production or by construction.
- B. Defining defects of unclear origin and means of their elimination can only be realized with the assistance of the manufacturer and the user representatives.
- C. RADWAG does not bear any responsibility for damage or losses resulting from unauthorized or inadequate performing of production or service processes.
- D. The warranty does not cover:
 - mechanical damage caused by product exploitation other than intended, damage of thermal and chemical origin, damage caused by lightning, overvoltage in the power network or other random event,
 - inappropriate cleaning habits.
- E. Loss of warranty takes place if:
 - a repair is carried out outside RADWAG authorized service point,
 - service claims intrusion into mechanical or electronic construction by unauthorized people,
 - the scale does not bear security seal stickers.
- F. Warranty conditions outline the warranty period for rechargeable batteries attached to the device for 12 months.
- G. For detailed warranty conditions read the warranty certificate.
- H. Contact with the central authorized service: +48 (48) 386 63 30.

3. MAINTENANCE ACTIVITIES

In order to ensure safety in the course of cleaning, it is necessary to disconnect the device from the mains. With this condition met, uninstall the weighing pan and other detachable components.

	<p><i>Cleaning the weighing pan while still installed may cause damage of the measuring system.</i></p>
---	--

3.1. Cleaning Stainless Steel Components

Avoid using cleansers containing any corrosive chemicals, e.g. bleach (containing chlorine). Do not use cleansers containing abrasive substances. In order to avoid damage of protective coating always remove the dirt using microfiber cloth.

Daily cleaning routine (removal of small stains):

1. Remove the dirt using cloth dipped in warm water.
2. For best results, add a little bit of dishwashing detergent.

3.2. Cleaning ABS Components

To clean dry surfaces and avoid smudging, use clean non-colouring cloths made of cellulose or cotton. You can use a solution of water and detergent (soap, dishwashing detergent, glass cleaner). Gently rub the cleaned surface and let it dry. Repeat the cleaning process if needed.

In the case of hard to remove contamination, e.g. residues of adhesive, rubber, resin, polyurethane foam etc., you can use a special cleaning agents based on a mixture of aliphatic hydrocarbons that do not dissolve plastics. Before using the cleanser for all surfaces we recommend carrying out tests. Do not use cleansers containing abrasive substances.

4. MECHANICAL DESIGN

4.1. Dimensions

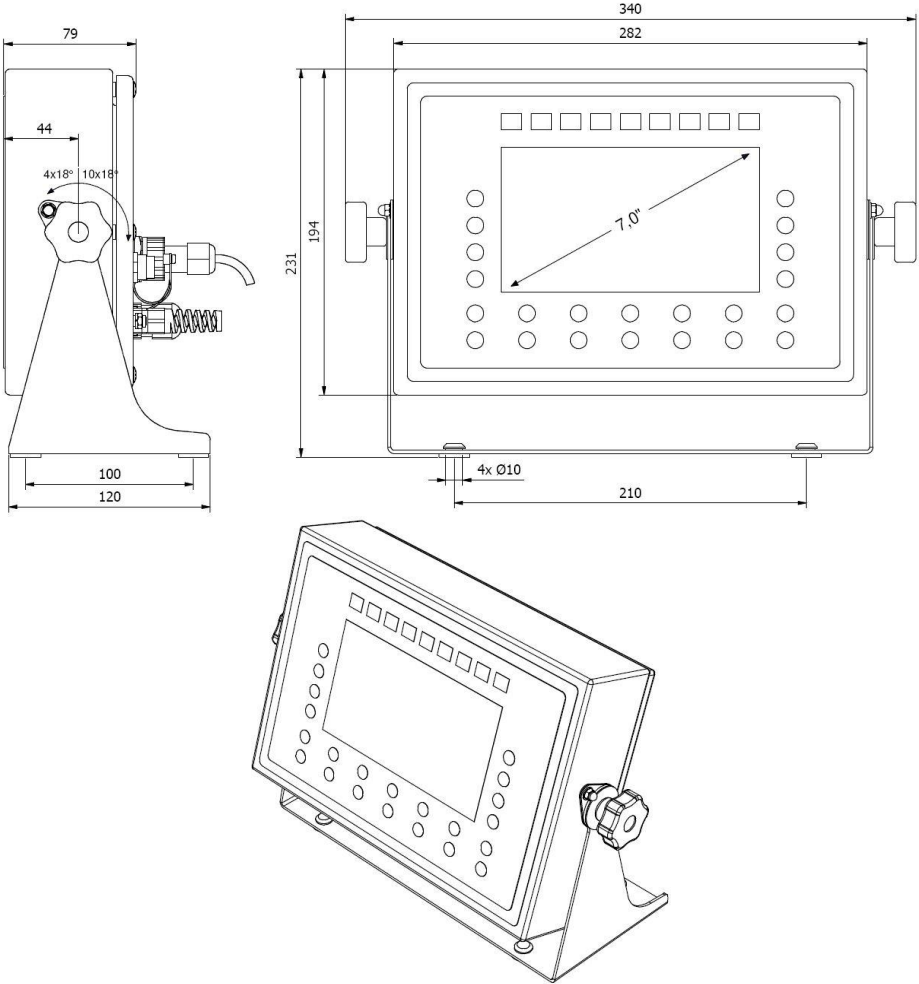

PUE HX7 overall dimensions



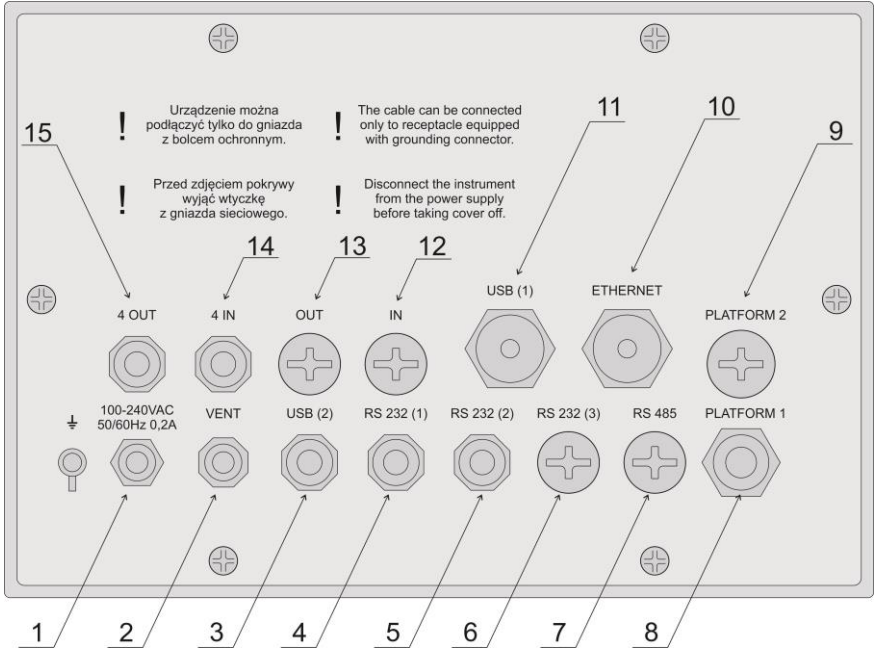

4.2. Connectors Arrangement



PUE HX7 connectors

1	Cable gland for power cord
2	Valve
3	USB 2 M12 4P connector (option)
4	RS232 M12 8P connector
5	RS232 M12 8P connector (option)
6	RS232 M12 8P connector (option)
7	RS485 M12 8P connector (option)
8	Cable gland for a cable of a weighing platform 1
9	Cable gland for a cable of a weighing platform 2 (option)
10	ETHERNET RJ45 connector
11	USB connector
12	IN connector for additional interfaces (PROFIBUS)
13	OUT connector for additional interfaces (PROFIBUS, analog outputs)
14	Digital 4OUT M12 8P connector
15	Digital 4IN M12 8P connector

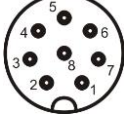
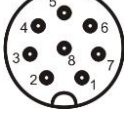
4.3. Pins Arrangement

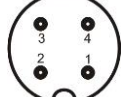
<p>RS232 RS232 (2) RS232 (3)</p>		<p>Pin1 – NC Pin2 – Rx/D Pin3 – Tx/D Pin4 – NC Pin5 – GND Pin6 - +5VDC Pin7 – GNDZ Pin8 – 24VDC</p>
<p>RS485</p>		<p>Pin1 – B Pin2 – NC Pin3 – NC Pin4 – A Pin5 – GND Pin6 - GND Pin7 – 24VDC Pin8 – 24VDC</p>
<p>4INPUTS</p>		<p>Pin1 – OUT1 Pin2 – OUT2 Pin3 – WY3 Pin4 – OUT4 Pin5 – COM Pin6 – 24VDC Pin7 – GND Pin8 – NC</p>
<p>4OUTPUTS</p>		<p>Pin1 – IN1 Pin2 – IN2 Pin3 – IN3 Pin4 – IN4 Pin5 – COM Pin6 – 24VDC Pin7 – GND Pin8 – NC</p>
<p>PROFIBUS IN (female)</p>		<p>Pin1 – NC Pin2 – A Pin3 – NC Pin4 – B Pin5 – NC</p>
<p>PROFIBUS OUT (male)</p>		<p>Pin1 - +5V Pin2 – A Pin3 – GND Pin4 – B Pin5 – NC</p>
<p>USB 2</p>		<p>Pin1 – Vcc Pin2 – D- Pin3 – D+ Pin4 – GND</p>

4.4. Inputs / Outputs

Standard HX7 indicator is equipped with 4 optoisolated inputs and 4 semiconductor outputs (semiconductor relays). The signals are fed through M12 8P connectors.

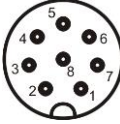
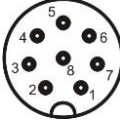
4OUTPUTS		Pin1 – OUT1 Pin2 – OUT2 Pin3 – WY3 Pin4 – OUT4 Pin5 – COM Pin6 – 24VDC Pin7 – GND Pin8 – NC
4INPUTS		Pin1 – IN1 Pin2 – IN2 Pin3 – IN3 Pin4 – IN4 Pin5 – COM Pin6 – 24VDC Pin7 – GND Pin8 – NC

4.4.1. Technical Specifications

Output parameters	
Output quantity	4
Output type	Solid-state relay
Cable cross-section	0.14 - 0.5mm ²
Maximum output current	0.5A DC
Maximum output voltage	30VDC, AC

Input parameters	
Input quantity	4
Input type	Optoisolated
Cable cross-section	0.14 – 0.5mm ²
Input voltage range	5 -24VDC



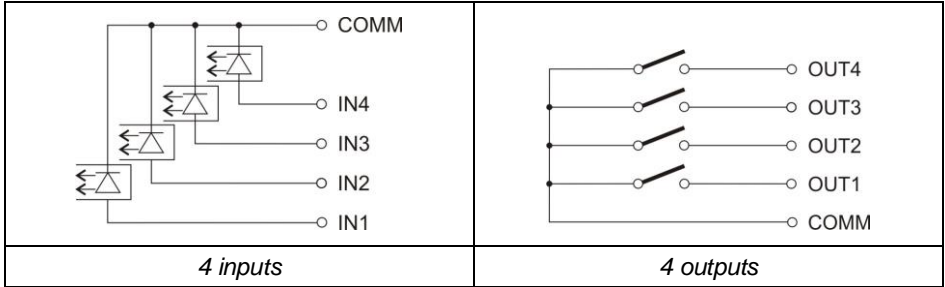

4.4.2. I/O Schematic Diagrams

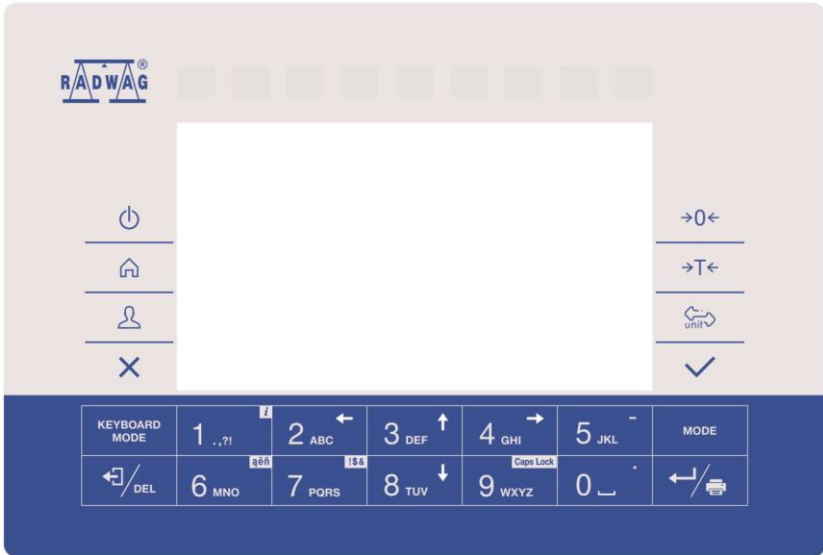













4.5. Operation Panel



Keys

	Press to switch the device on / off.
	Press to enter the main menu.
	Press to log in.
	Press to cancel the message.
	Press to zero the scale.

	Press to tare the scale.
	Press to change the weighing unit.
	Press to confirm the message.
	Press to confirm the weighing result (PRINT). Press to confirm the messages (ENTER).
	Press to cancel the message.
	Press to change the working mode.
	Programmable key assigned to an on-screen button.  key – long press to get scale info.
	Programmable key assigned to an on-screen button.
	Programmable key assigned to an on-screen button.
	Programmable key assigned to an on-screen button.
	Programmable key assigned to an on-screen button.

4.6. Technical Specification

Housing	Stainless steel
IP rating	IP68 / IP69
Display	7" colour
Power supply	100-240VAC 50-60Hz
Optional power supply	Internal battery
Operating temperature	-10 °C + 40 °C
Maximum signal gain	19.5 mV
Maximum load cell impedance	1200 Ω
Minimum load cell impedance	50 Ω
Load cell wiring	4 or 6 wires + shield
Weighing platform quantity	1 (optionally 2)
RS232	M12 8P connector
USB	USB A connector
Ethernet	RJ45 connector
IN/OUT	4IN – M12 8P connector; 4OUT – M12 8P connector

Optional Equipment

12IN/12OUT module	12IN/12OUT cable gland
AN analog output module	4 - 20 mA, 0 - 20 mA, 0 - 10 V
Profibus module	2 x M12 5P connector
RS485	M12 8P connector
RS232 x 2	M12 8P connector

5. INDICATOR INSTALLATION

5.1. Unpacking and Installation

- Take the indicator out of the packaging.
- Connect the indicator to a weighing platform, next place the weighing device on a flat and even surface. Keep it far away from any sources of heat.
- It is necessary to level the scale, do it by turning its feet. Keep turning the feet until the air bubble takes central position:

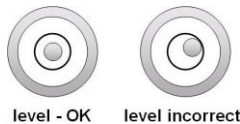







5.2. Start-Up

- Plug the power cord to the mains.
- Press  key, it is to be found at the top of the operation panel.
- Upon completed start-up, the home screen is displayed automatically.

5.3. Battery Status

Optional scale design features an internal battery.  pictogram, displayed at the top of the screen, either signals battery status or informs that battery charging is in progress:

-  pictogram displayed in a cyclic manner: battery charging.
-  pictogram displayed continuously: battery charged within 75% - 100% range of permissible voltage,
-  pictogram displayed continuously: battery charged within 50% - 75% range of permissible voltage,
-  pictogram displayed continuously: battery charged within 25% - 50% range of permissible voltage,

-  pictogram displayed continuously: battery discharged (charge level below 25% of the permissible voltage), connect the scale to the mains in order to charge it,
- blinking  pictogram: damaged battery or battery lack,
- no  pictogram: scale not equipped with the battery.

	Battery discharge is signalled by the following message: <Excessively discharged battery. Scale shutdown is to occur>. Upon scale shutdown, connect it to the mains in order to charge the battery.
---	--

6. HOME SCREEN

The home screen features 4 sections: a top bar, a weighing result window, workspace, pictograms.

Home screen view:











	Detailed instruction on how to configure the home screen is to be found in „PUE HX7 indicator software manual”.
---	--

6.1. Top Bar



The top bar displays the following information:

 Weighing	Working mode name and symbol.
PUE HX7	Device name.

	Wireless communication on.
	Communication with the USB flash drive on.
	PC keyboard connected.
	Printer connected.
	Battery charge status.
	Communication with a PC on.
	Communication with the E2R SYSTEM on.

6.2. Weighing Result Window

Weighing result window provides all weighing-related data.



6.3. Workspace

The workspace is to be found underneath the weighing result window.

Product:	Tare: 0.000 kg
User:	Sum: 0.000 kg

The workspace comprises 4 programmable widgets. Each working mode features a default home screen widget set. You can customize the screen.

6.4. Pictograms

The pictograms assigned to operation panel keys are to be found underneath the workspace.



You can define on-screen pictograms individually for each working mode.

7. OPERATING THE MENU

In order to navigate the program menu use the operation panel.







7.1. Entering the Menu

In order to enter the menu press  key. Background colour of the first menu entry differs from the remaining ones. To navigate the program menu use the keys that operate as arrow keys.

Menu view



7.2. Menu Keys

	Press to enter the main menu. Press to go to the home screen.
	Press to go back, or to discard entering parameter modifications.
	Press to go back. Press to delete a character when editing numeric and text values.
	Press to change keyboard mode when editing numeric and text values.
	Press to select/change working mode.
	Press to confirm/accept modifications.
	Press to go back, or to discard entering parameter modifications.

3 DEF ↑	Press to go up the menu, or to edit parameter value and change it by one digit up.
4 GHI →	Press to select parameter group that you want to operate. The first parameter of the selected parameter group is displayed.
8 TUV ↓	Press to go down the menu, or to edit parameter value and change it by one digit down.

7.3. Entering Numbers / Text

The software features two different edit boxes:



- numerical box (for entering part mass values, tare values, etc.).
- text box (for entering printout template, universal variable value, etc.).

Button functions change depending on the edit box type.

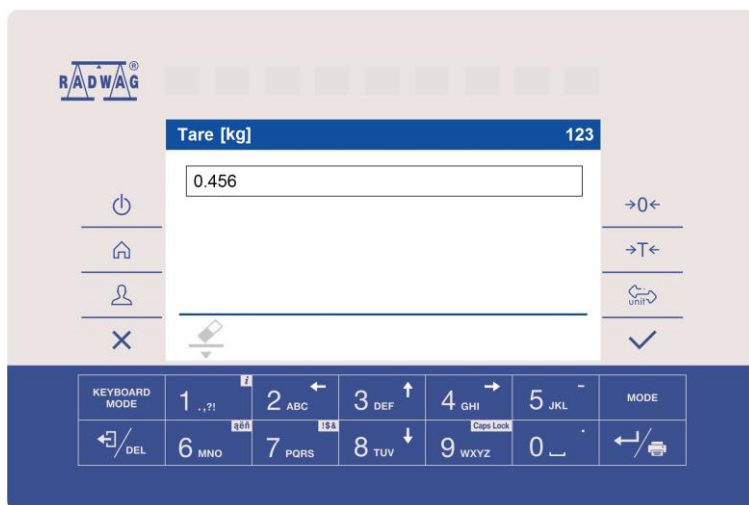













7.3.1. Numerical Box



Where:

123	Digit mode. To change keyboard working mode press KEYBOARD MODE key. Keyboard working mode options: 123 - digit mode,  - arrow keys operation, Fn - bottom bar operation.
	Press to clear box content.







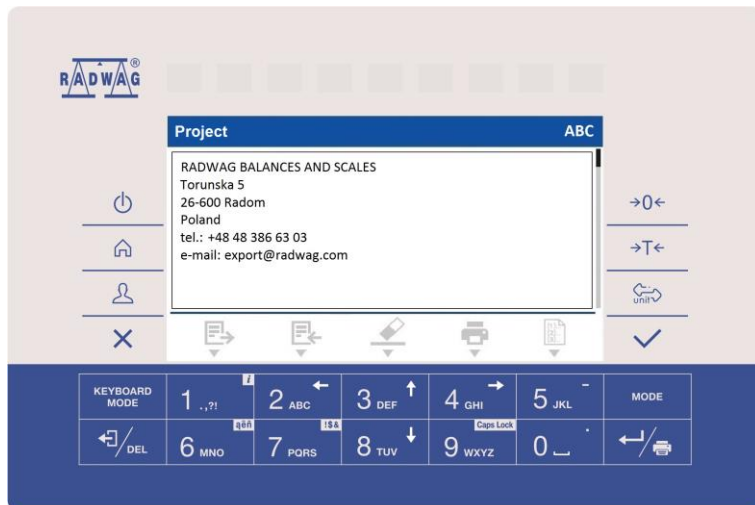





Keys

	Press to enter digit 1.
	Press to enter digit 2.
	Press to enter digit 3.
	Press to enter digit 4.
	Press to enter digit 5. Press to enter „-“ (minus), hold the key for a few seconds (long press).
	Press to enter digit 6.
	Press to enter digit 7.
	Press to enter digit 8.
	Press to enter digit 9.
	Press to enter digit 0. Press to enter „.” (dot), hold the key for a few seconds (long press).
	Press to delete one character.
	Press to exit, the edit box content remains unmodified.
	Press to confirm the modifications.
	Press to change keyboard working mode.

7.3.2. Text Box



Where:

	<p>Upper-case character mode. To change keyboard working mode press  key. Keyboard working mode options:  - upper-case character mode,  - lower-case character mode,  - digit mode,  - arrow keys operation,  - bottom bar operation.</p>
	<p>Press to save the project to *.lb file on a USB flash drive.</p>
	<p>Press to read the project saved to *.lb file on a USB flash drive.</p>
	<p>Press to clear box content.</p>
	<p>Press to print the project using a printer connected to the scale.</p>
	<p>Press to view list of variables that can be used in the project.</p>

Keys

	Press to enter . , { } : ° - .
	Press to enter a b c. Press to move the cursor to the left, long press.
	Press to enter d e f. Press to move the cursor up, long press.
	Press to enter g h i. Press to move the cursor to the right, long press.
	Press to enter j k l. Press to enter „ - ” sign, long press.
	Press to enter m n o. Press to activate „,ăěň” function (diacritical sign table), long press.
	Press to enter p q r s. Press to activate „!\$&” function (special signs table).
	Press to enter t u v. Press to move the cursor down, long press.
	Press to enter w x y z. Press to activate „Caps Lock” function, long press.
	Press to enter (space) sign. Press to enter „.” sign (dot), long press. ”.
	Press to go to the next line in the edit box.
	Press to delete one character.
	Press to exit, the edit box content remains unmodified.
	Press to confirm the modifications.
	Press to change keyboard working mode.

7.3.3. Diacritical Sign Table

In order to activate the diacritical sign table while editing a text box, it is necessary to press and hold down key. Diacritical signs characteristic for a particular interface language are automatically added to the table when the given language gets selected.

Diacritical sign table: Polish.	Diacritical sign table: English, German, French, Spanish.
ą ć ę ł ń ó ś ź ż á č	ä ö ü à â æ œ ç è é ê
đ é ě í ñ ř š ú û ý ž	ë î ï ô ù û ü ÿ ñ á ã
â ă ä å ĩ î ċ ǒ Ǔ ǔ ǖ ǘ	â ï í ǒ ò ó õ ú ý þ š
⬆️ !\$& ũ ü ł ą å ø æ	⬆️ !\$& ž ğ ş ø ç ß

Where:

⬆️	Press to activate „ Caps Lock ” function.
!\$&	Press to switch to special sign keyboard.

7.3.4. Special Sign Table

In order to activate special signs table while editing text box it is necessary to press and hold  key.



,	.	?	'	!	"	-	()	@	/
:	_	;	+	&	%	*	=	<	>	£
€	§	¥	°	[]	{	}	\	~	^
⬆️	ąęń	#	\$		μ	ß	©	®	™	`

Where:

⬆️	Function inactive.
ąęń	Press to switch to diacritical sign keyboard.

7.4. Return to Weighing

Introduced modifications are automatically recorded upon return to the home screen. To return to the home screen:

- press  key repeatedly, keep pressing the key until you see the home screen,
- press  key, the home screen is displayed immediately.

8. INSTALLER INSTRUCTION

The PUE HX7 indicator serves as basis of load cell scales.

8.1. Connecting 6-Wire Load Cell

Connect 6-wire load cell to the main board following the diagram below:

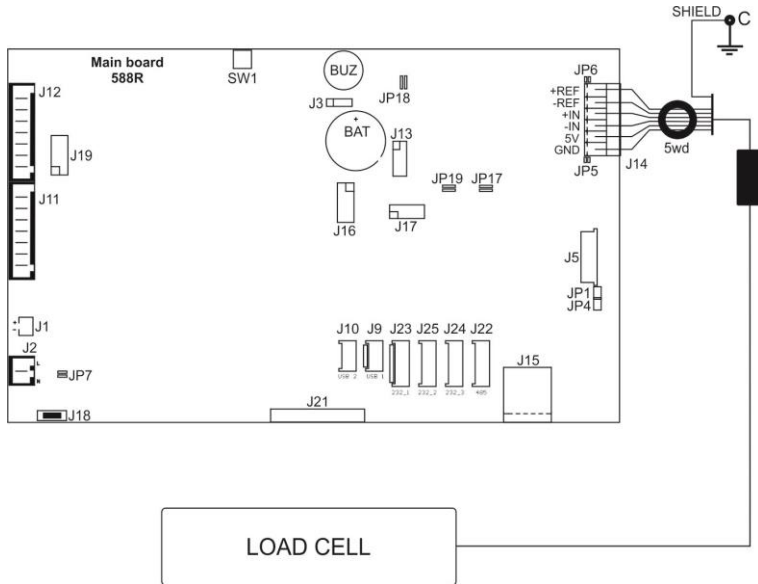

6-wire load cell connection

Load cell junction J14	Load cell signals	NOTES
REF+	SENSE +	JP6 not soldered
REF-	SENSE -	JP5 not soldered
IN+	OUTPUT+	
IN-	OUTPUT-	
+5V	INPUT+	
AGND	INPUT-	

8.2. Connecting 4-Wire Load Cell

Connect 4-wire load cell to the main board following the diagram below:

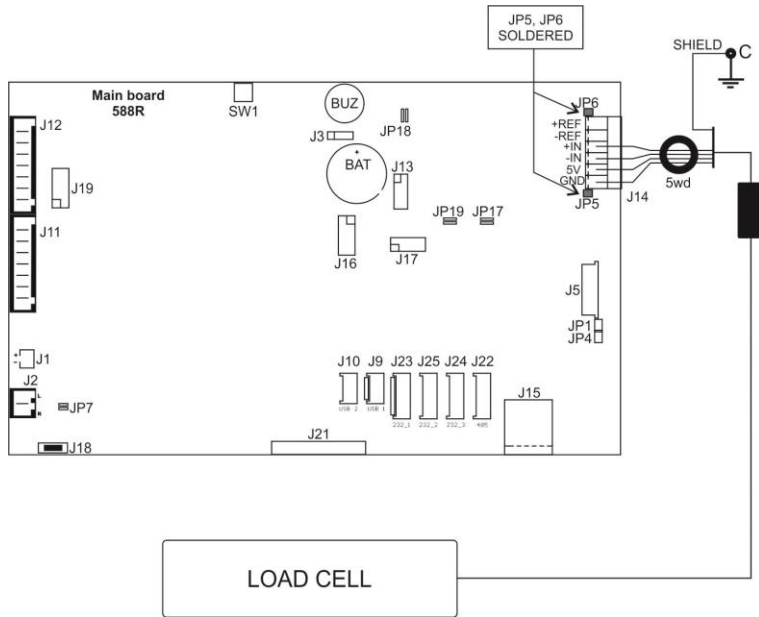

Connecting 4-wire load cell

Load cell junction J14	Load cell signals	Notes
REF+	-	JP6 soldered
REF-	-	JP5 soldered
IN+	OUTPUT+	
IN-	OUTPUT-	
+5V	INPUT+	
AGND	INPUT-	

8.3. Connecting Load Cell's Cable Shield

To ensure correct scale operation, follow below instructions regarding connection of shield of load cell's signal cable. The same rules apply for both cases, platforms with 6-wire load cells and platforms with 4-wire load cells:

	Scale with an indicator in a metal housing connected with a platform via a load cell signal cable.	Scale of compact mechanical design with an indicator in a metal housing connected with the platform via a post, etc.
Platform w/o galvanic connection of the signal cable shield.	POINT C	E
Platform with galvanic connection of the signal cable shield.	POINT C	POINT C



Point C – threaded pin, galvanically connected with an indicator housing (for fixing of a ring terminal),

E – solder pad on **DP4** module.

9. FACTORY SETUP

To access and modify factory settings and parameters that are made available for a user, run Factory Setup mode. Running Factory Setup mode enables the technician to define the scale.

9.1. Factory Setup Access



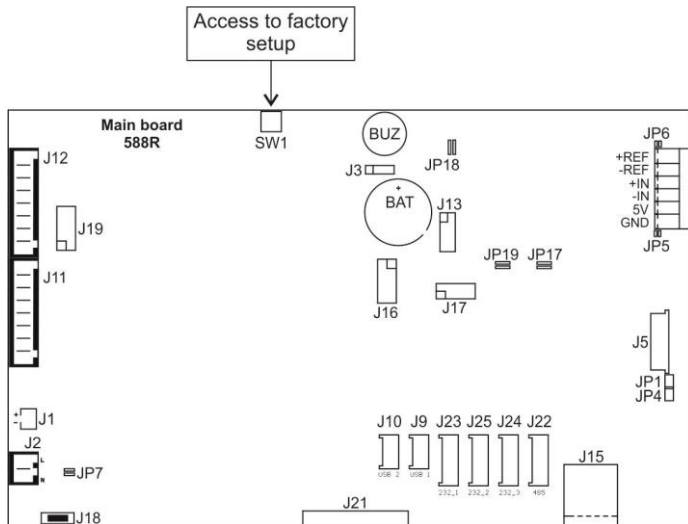



- Switch the weighing device off, to do it press  key.
- Press and hold **SW1** switch located on the electronics board, while holding the SW1 switch, press  key to run the weighing device.



Factory Setup access switch

- Upon completed start-up, weighing result window is displayed automatically.
- Press  button to enter the home screen. Two submenus are displayed: <Global> and <Factory>.

9.2. Global Parameters

NAME	DEFAULT	VALUES	DESCRIPTION
Scale defining	-	-	Defining the device at the production stage (refer to section 9.5).
Scale type	PUE HX7	PUE HX7, HX7, HRP	Setting scale type. For PUE HX7 value no metrological data is displayed, only the weighing indicator name.
Top bar - metrology	-	-	Settings regarding display of metrological data in a top bar of the home screen.
Activation	 No	 Yes  No	Enabling / disabling display of metrological data in a top bar of the home screen.
Scale name	-	-	Special name and/or name of RADWAG distributor's device (15 characters maximum). Value entered here replaces the set „ Scale type ” value.
Platform quantity	1	1, 2	Weighing platform quantity
Serial number	0	-	Serial number of the scale.
Battery	None	None, NIMH, SLA, TSLA	Battery selection.
Customer	None	None, D, A, B, V, SC	Declaring the customer: D - KERN, A - ADEMI, B - BOECO, V - VWR, SC – Schuller.
NTEP	 No	 No  Yes	Enabling / disabling modifications in „Parts Counting” mode for verified scales (USA market).
Service	-	-	Service settings menu.
Battery diagnostics	-	-	Preview of operation parameters and battery charge-up.
RTC adjustment	-	-	RTC synchronisation.
Operation time	-	-	Total operation time, time format: "D: xx H: yy" (D - day, H - hour).
CPU Id	-	-	Processor number, necessary to generate code unlocking Wi-Fi module.

Restore default operator settings	-	-	Restoring default settings (factory and user parameters).
--	---	---	---

9.3. Factory Parameters

NAME	DEFAULT	VALUES	DESCRIPTION
Metrology	-	-	Metrology related settings
Mass divisions	-	-	Display of converter divisions.
Adjustment unit	kg	g, kg, lb	Adjustment unit.
GCOR coefficient	1	0.9 ÷ 1.1	Gravitational correction factor.
Reading unit - Range 1	0.001	0.0000001 ÷ 50	Reading units for Range 1.
Verification unit - Range 1	None	None, 0.001, 0.002, 0.005, 0.01, 0.02, 0.05, 0.1, 0.2, 0.5, 1, 2, 5, 10, 20, 50	Verification units for Range 1, 'none' value - unverified version.
Reading unit - Range 2	0.001	0,0000001 ÷ 50	Reading units for Range 2.
Verification unit - Range 2	None	None, 0.001, 0.002, 0.005, 0.01, 0.02, 0.05, 0.1, 0.2, 0.5, 1, 2, 5, 10, 20, 50	Verification units for Range 2, 'none' value - unverified version.
Digit marker	None	None, 1, 2, 3	Setting quantity of digits (counting from the last digit of the displayed result) over which a marker is to be displayed and printed out in case of unverified scales.
Max range	3.009	-	Maximum capacity + overload.
Range 2 threshold	0.000	-	II range switching point. For single range scales set 0.
External adjustment weight	3.000	-	Mass of an external adjustment weight.
Autozero range	Predefined	Predefined, 0.1, 0.2, 0.25, 0.5, 0.6, 0.7, 0.8, 0.9, 1, 2, 2.5, 3, 4, 5, 6, 7, 8, 9, 10.	Autozero range [d]: Predefined - value taken from program-implemented tables; 0.1 ÷ 10 - value entered directly by a user.
Autozero time	Predefined	Predefined, 0, 0.2, 0.4, 0.6, 0.8, 1, 2, 3, 4, 5, 6, 7, 8, 9, 10, 15, 20.	Autozero time [s]: Predefined - value taken from program-implemented tables; 0 ÷ 20 - value entered directly by a user.



Stability range	Predefined	Predefined, 0.1, 0.2, 0.25, 0.5, 0.6, 0.7, 0.8, 0.9, 1, 2, 2.5, 3, 4, 5, 6, 7, 8, 9, 10.	Stability range [d]: Predefined - value taken from program-implemented tables; 0.1 ÷ 10 - value entered directly by a user.
Stability time	Predefined	Predefined, 0, 0.2, 0.4, 0.6, 0.8, 1, 2, 3, 4, 5, 6, 7, 8, 9, 10, 15, 20.	Stability time [s]: Predefined - value taken from program-implemented tables; 0 ÷ 20 - value entered directly by a user.
Start mass control	Yes	Yes, No, 50%, Definable.	Start mass control: YES – range: -10% to +10% of start mass, No – off, 50% range: -50% to +50% of start mass, Definable – range declared in 'Start mass threshold' parameter.
Start mass threshold	10	10% ÷ 90%	Start mass value range in [%].
Adjustment	-	-	Weighing instrument adjustment menu
External adjustment	-	-	Scale adjustment (refer to section 9.6.1).
Start Mass Determination	-	-	Start mass determination (refer to section 9.6.2).
Start mass	100	-	Current start mass expressed in converter's divisions.
Adjustment factor	100	-	Current adjustment coefficient.
Factory start mass	100	-	Start mass value expressed in converter's divisions, read in the course of the factory adjustment.
Factory adjustment factor	100	-	Adjustment factor value, determined during the factory adjustment.
Section linearity	-	-	Section linearity correction (refer to section 9.7).
Determine	-	-	Determining linearity correction points.
Corrections	-	-	Entering corrections for linearity correction points.
Delete	-	-	Deleting linearity correction.
Definable filter		 Inactive  Active	Activation and factory determination of filter dynamics.
Restore default factory settings	-	-	Restoring default factory settings.



The above table presents menu structure for one platform. When more than one platform are in use, enter <Factory parameters> menu to see a list of all the platforms. Each platform is defined by an analogous set of parameters (presented above).

9.4. Return to Weighing





Introduced modifications are automatically recorded upon return to the home screen. To return to the home screen:

- press  key repeatedly, keep pressing the key until you see the home screen,
- press  key, the home screen is displayed immediately.

9.5. Scale Defining

Defining the device at the production stage requires entering basic scale parameters: serial number, weighing device type.

Procedure:



- Enter **<Global / Scale defining>** submenu, message **<Continue?>** is displayed.
- Press  key, **<Serial number>** edit box is displayed.
- Enter the serial number, do it using the operation panel.
- Press  key to confirm, **<Scale type>** list is displayed.
- Select the scale, do it using the operation panel (refer to global parameters table, section 9.2 of this manual).
- Press  key to confirm, **<Global>** submenu is displayed.
- Exit to the home screen, to do it press  key repeatedly.



While defining scale type, additional parameters are set automatically. These are among many battery type, filter settings, etc.

9.6. Factory Adjustment

9.6.1. External Adjustment

- Enter **<Factory/Adjustment>** submenu.
- Select **<External adjustment>** parameter. Message **<Remove weight>** is displayed.
- Unload the weighing pan and press  key to confirm.
- Message **<Adjustment. Please wait...>** is displayed.
- Upon completed start mass determination procedure, message **<Put weight xxx>** is displayed (where: xxx – adjustment weight mass).
- Load the weighing pan with a required adjustment weight and press  key to confirm. Message **<Adjustment. Please wait...>** is displayed.
- Upon adjustment completion, message **<Remove weight>** is displayed.
- Unload the weighing pan, the weighing device displays the **<Adjustment>** submenu.



The adjustment of additional platform is performed likewise.

9.6.2. Start Mass Determination

- Enter **<Factory/Adjustment>** submenu.
- Select **<Start mass determination>** parameter. Message **<Remove weight>** is displayed.
- Unload the weighing pan and press  key to confirm.
- Message **<Start mass determination. Please wait...>** is displayed.
- Upon completed determination process, the weighing device displays the **<Adjustment>** submenu.







Process of determination of start mass for an additional platform calibration is analogous.

9.7. Linearity Correction

9.7.1. Linearity Determination

Declaring mass values for subsequent linearity steps and determining corrections using scale software.

Procedure:

- Enter **<Factory/Section linearity>** submenu and select **<Determine>** parameter. Message **<Continue?>** is displayed.
- Press  key to confirm. **<Mass>** edit box is displayed.
- Unload the weighing pan.
- Enter the required mass value (the first linearity correction point) and press  key to confirm. Message **<Put weight xxx>** is displayed (where: xxx – entered mass value) is displayed.
- Load the weighing pan remembering that the load mass must equal weight value specified for the first linearity correction point (it is possible to preview the weighing result in the displayed window).
- Upon result stabilization, press  key to confirm. **<Mass>** edit box is displayed again (second linearity correction point).
- Linearity correction process for the 2nd point is analogous to the linearity correction process for the 1st point.
- Upon declaring requested quantity of linearity correction points, press  key when **<Mass>** edit box is displayed again.
- **<Section linearity>** submenu is displayed automatically.





*Upon pressing  key to confirm zero value for linearity correction, message: **<Value too low>** is displayed.*

9.7.2. Corrections

Editing corrections for linearity correction points.

Procedure:

- Enter **<Factory/Section linearity>** submenu.
- Select **<Corrections>** parameter. A list of determined linearity correction points is displayed. The list contains previously determined mass values for each correction point and deviations determined in reading units.
- Select requested position, **<Mass>** edit box is displayed.

- Enter requested correction and/or press  key to confirm. **<Correction>** edit box is displayed automatically.
- Enter requested correction and/or press  key to confirm. **<Corrections>** submenu is displayed automatically.

9.7.3. Deleting Linearity

- Enter **<Factory/Section linearity>** submenu.
- Select **<Delete>** parameter. Message **<Delete?>** is displayed.
- Press  key to confirm.

9.8. Gravitational Coefficient

The function of gravity correction compensates changes of gravity force being a result of different latitude. It allows to carry out correct scale calibration/adjustment away from the point of subsequent use. The gravity correction value must be entered with reference to tables prepared by „Radwag Balances and Scales” or calculated using the below formula:

$$G_{cor} = \frac{g_{uzyt.}}{g_{kal.}}$$

Correction value ranges between 0.90000 ÷ 1.99999.



If the weighing instrument is calibrated in the place of use, then the value of <GCOR coefficient> parameter must be 1.00000. If the weighing instrument is calibrated away from the place of use (longitudinal change) the value must be corrected.

10. OPTIONAL EXTENSION MODULES

10.1. Additional 12IN/12OUT Module

The module has been designed to expand indicator's functionality by additional 12 inputs and 12 outputs. It is equipped with optoisolated inputs and semiconductor outputs and enables free configuration of both the inputs and outputs (using indicator menu). For 12IN/12OUT module, the indicator's housing cover features two cable glands through which 3-meter long leads, terminated with strip wires, are fed.

10.1.1. Technical Specifications

Output parameters	
Output quantity	12
Output type	Solid-state relay
Cable cross-section	0.14 - 0.5mm ²
Maximum output current	0.5A DC
Maximum output voltage	30VDC, AC
Input parameters	
Input quantity	12
Input type	Optoisolated
Cable cross-section	0.14 – 0.5mm ²
Input voltage range	5-24V DC

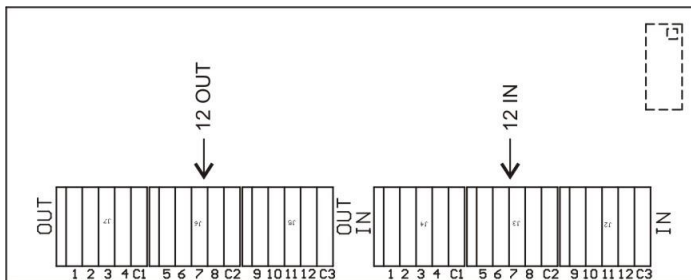

12IN/12OUT module

10.1.2. 12IN/OUT Schematic Diagrams

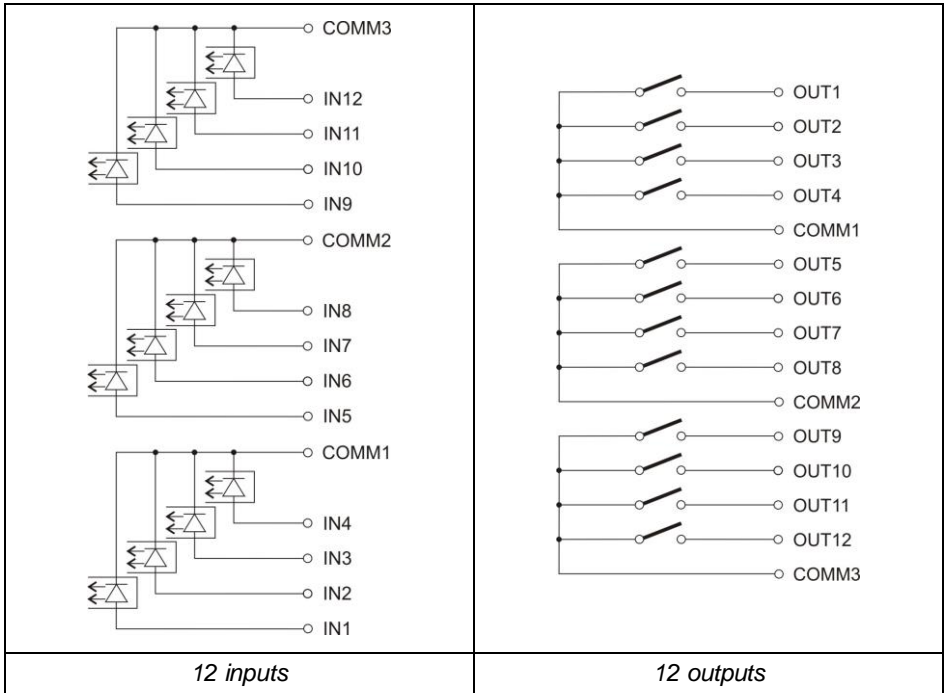

10.1.3. Input / Output Signals Overview

Signals transmitted via 16 x 0.5 mm² cable with numbered wires.

INPUTS		OUTPUTS	
Wire number	Signal	Wire number	Signal
1	IN1	1	OUT1
2	IN2	2	OUT2
3	IN3	3	OUT3
4	IN4	4	OUT4
5	COMM1	5	COMM1
6	IN5	6	OUT5
7	IN6	7	OUT6
8	IN7	8	OUT7
9	IN8	9	OUT8
10	COMM2	10	COMM2
11	IN9	11	OUT9

12	IN10	12	OUT10
13	IN11	13	OUT11
14	IN12	14	OUT12
15	COMM3	15	COMM3

10.2. AN analog output module

There are three different modes:

- **AN 0 - 10 V.**
- **AN 4 - 20 mA.**
- **AN 0 - 20 mA.**

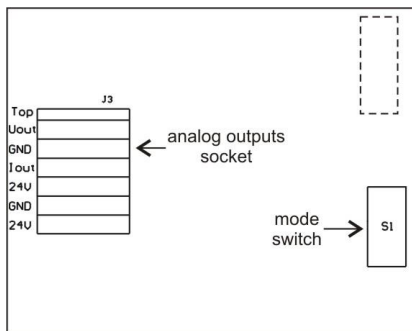

AN analog output module

10.2.1. AN Module Configuration

The module's working mode is set using **S1** switch, when setting the module's working mode refer to the below table. Analog outputs module board provides description of settings, for the description look around **S1** switch.

R1	R2	OPERATION MODE
0	0	0-10V
0	1	4-20mA
1	0	0-20mA
1	1	0-24mA

BY DEFAULT SET ANALOG OUTPUTS MODULE TO 4 - 20 mA MODE.

Analog output must be calibrated (adjusted); using P1 potentiometer set the correct offset (e.g. for 4 - 20mA output, adjust current so that for 0kg indication it is precisely 4mA). In case of remaining operation modes proceed analogously.

10.2.2. Technical Specifications

Operation mode	4 - 20mA, 0 - 20mA, 0 - 10V
Resolution	16 bit
Current output resistance	< 500 Ω
Voltage output resistance	>400Ω
Power supply	24VDC (12 - 30V DC), max 40mA

10.2.3. AN Module: Diagrams of Connection Cables

Voltage output wiring diagram

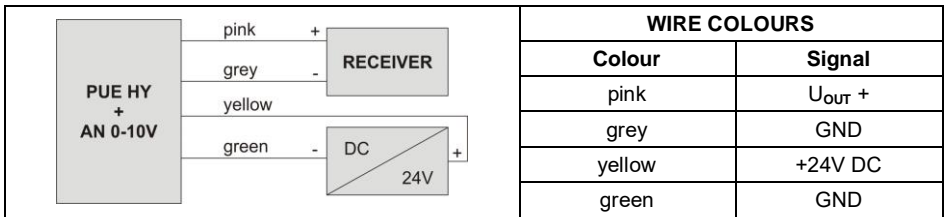

Current output wiring diagram

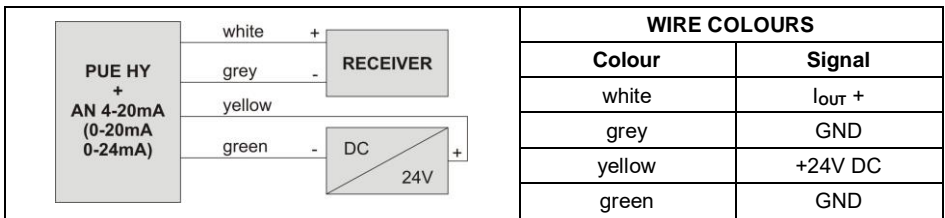

10.3. Additional Platform Module, DP6

The DP6 module expands indicator functionality, with it an additional platform can be operated. The module is intended to be mounted inside the indicator. For DP6 module (484Rxxxx board), the indicator's housing cover features an additional cable gland through which an additional platform cable is fed.

10.3.1. Technical Specification

Operating temperature	-10°C + 40°C
OIML	III
Verification unit	6000
Max input signal	19.5 mV
Maximum voltage per verification unit	3.25 µV
Minimum voltage per verification unit	0.4 µV
Minimum load cell impedance	50 Ω
Maximum load cell impedance	1200 Ω
Load cell power supply	5V
Load cell wiring	4 or 6 wires + shield
Multi range option	YES

10.3.2. Colours of Weighing Platform's Signal Wires

Markings RADWAG	Colour	Marking of terminals (solder pads) on RADWAG A/D converter boards
+INPUT	brown	+5V
-INPUT	green	AGND
+OUTPUT	yellow	+IN
- OUTPUT	white	-IN
+ SENSE	grey	+REF
- SENSE	pink	- REF
SHIELD	yellow-green	by shield connection guidelines

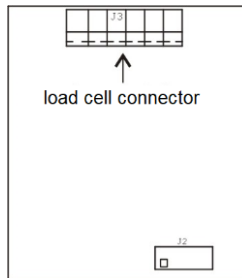

*Module of an additional A/D DP6 converter**

10.4. PROFIBUS Module

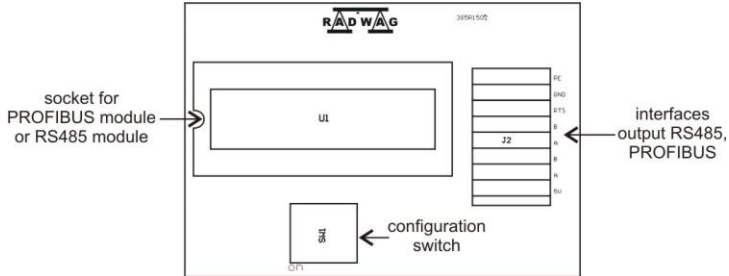

The PUE HX7 indicator can be equipped with PROFIBUS interface (option). This requires installation of **AB6000 Anybus-IC** module (Elmark Automatyka) in U1 socket of universal communication module board (385Rxxxx board, ver. A).



Position of PROFIBUS module on 385Rxxxx board (ver.A)

The indicator is equipped with input and output connectors. On the output connector there is 5 VDC voltage, this provides correct operation of a terminator. Connectors of M12 5 pin B-code standard are used (for PROFIBUS DP).

Pins arrangement

<p>PROFIBUS IN (male)</p>		<p>Pin1 – NC Pin2 – A Pin3 – NC Pin4 – B Pin5 – NC</p>
<p>PROFIBUS OUT (female)</p>		<p>Pin1 – +5V Pin2 – A Pin3 – GND Pin4 – B Pin5 – NC</p>

11. DIAGRAMS OF CONNECTION CABLES

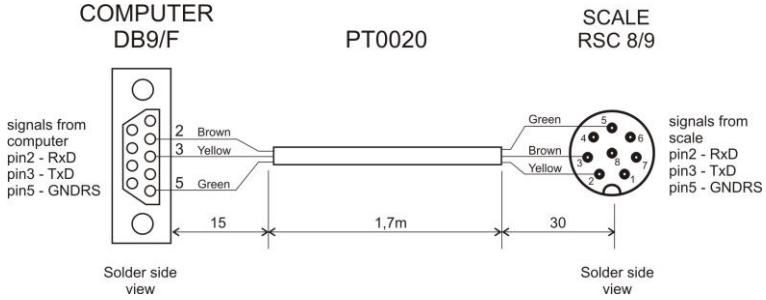

Indicator - computer cable

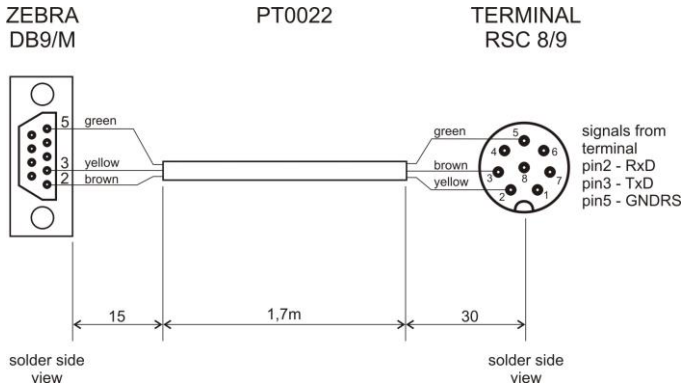

Indicator - printer cable (ZEBRA)

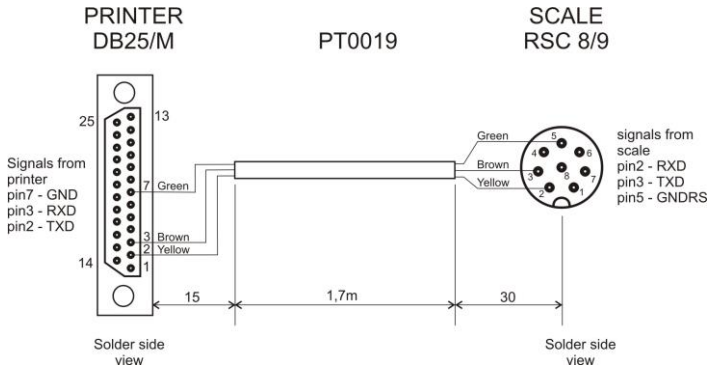

Indicator - printer cable (EPSON)

PT0256

TERMINAL
RSTS 8-184/2M

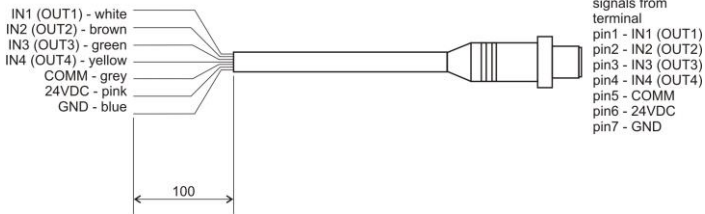

Indicator - IN/OUT cable

Symbol
LS2208

SCALE
RSC 8/9

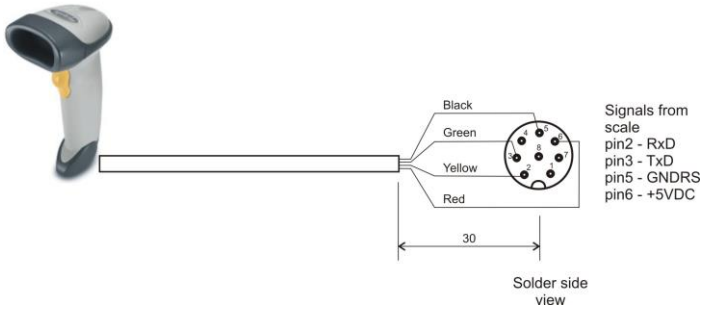

Indicator – barcode scanner cable (LS2208)

NOTE !!!
For STOP button use "NC" type contact.

PT0213

TERMINAL
RS8/9

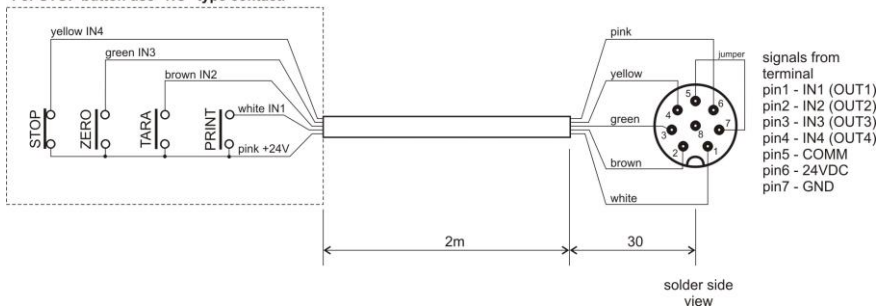

Indicator – PRINT, TARE, ZERO, STOP cable



„Scale-Ethernet” cable is a standard network cable terminated with RJ45 connectors on both ends.

12. ERROR MESSAGES



Start mass out of range.
Unload the weighing pan.



High limit of weighing range exceeded.
Unload the weighing pan.



Low limit of weighing range exceeded.
Install weighing pan.



Zeroing out of range.
Press tarring button or restart the scale.



Tarring out of range.
Press zeroing button or restart the scale.



Zeroing/tarring time out of range.
Weighing indication unstable.



Display capacity out of range
Unload the weighing pan



RADWAG BALANCES AND SCALES
ADVANCED WEIGHING TECHNOLOGIES

