

BW Clip4

Portable Gas Detector

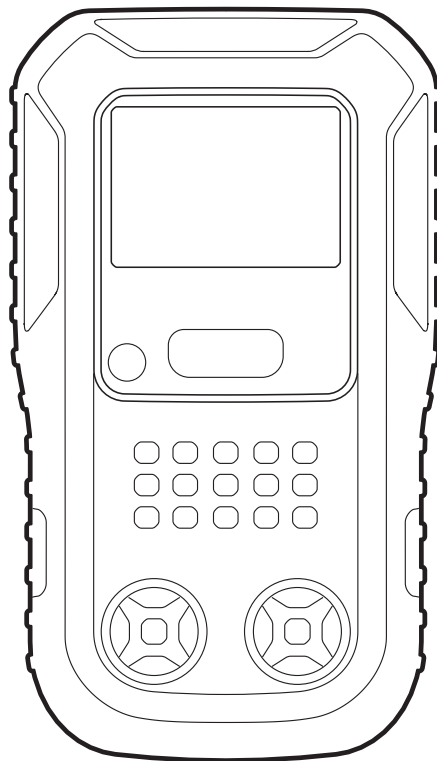



Safety Information

Use the detector only as specified in this manual and the reference guide, otherwise the protection provided by the detector may be impaired.

Read the following cautions before using the detector.

WARNING

- The BW Clip4 will not detect some combustible gases like Hydrogen or Acetylene. For detectable combustible gases, see Detectable Combustible Gases on page 29. If your application has one or more of these hazards, please consult Honeywell Analytics to determine the best solution.  
- Substitution of components may impair Intrinsic Safety.
- Honeywell Analytics recommends performing a bump test prior to each day's use to confirm sensor response and alarm activation by exposing the detector to a concentration of target gas that exceeds the low alarm set point. Honeywell Analytics also recommends performing a bump test if the detector has been subjected to physical impact, liquid immersion, an Over Limit alarm event, custody changes, or anytime the detectors performance is in doubt.
- Special Condition of Safe Use: The BW Clip4 is provided with anti-static coating over the LCD window to minimize risk of ignition due to electrostatic discharge. Periodic inspection of this coating is required to ensure no degradation, delamination, abrasions or other deformities to this surface. Care must be taken to avoid exposure to excessive heat, harsh chemicals or solvents, sharp edges and abrasive surfaces. Clean only with a damp cloth.
- The flammable sensor in BW Clip4 is infrared type sensor. The special care is needed: keep flammable sensor out of contact with aggressive substances e.g. acidic environments which can react with metals, as well as solvents which may affect polymeric mate-

rials. If BW Clip4's flammable sensor is suspected to be damaged by aggressive substances, please perform Bump Test and Calibration per this manual.

 CAUTION

- Activate the detector before the activation date on the package.
- This product is a gas detector, not a measurement device.
- Ensure that the sensor grill is free of dirt, debris, and is not obstructed.
- Clean the exterior with a soft, damp cloth.
- For optimal performance, periodically zero the sensor in a normal atmosphere (20.9% v/v O₂) that is free of hazardous gas.
- Portable safety gas detectors are life safety devices. Accuracy of ambient gas reading(s) is dependent upon factors such as accuracy of the calibration gas standard used for calibration and frequency of calibration. Honeywell Analytics recommends performing a calibration at least once every 180 days (6 months).
- The combustible gas sensor is initially calibrated to 50% LEL methane. Only methane gas should be used to calibrate or bump test the combustible gas sensor.
- Only the combustible gas detection portion of this instrument has been assessed for performance.
- High off-scale readings may indicate an explosive concentration.
- Any rapid up scaling reading followed by a declining or erratic reading may indicate a gas concentration beyond the upper scale limit, which can be hazardous.
- Products may contain materials that are regulated for transportation under domestic and international dangerous goods regulations. Return product in compliance with appropriate dangerous goods regulations. Contact freight carrier for further instructions.
- Recycling: this instrument contains a lithium battery. Do not mix with the solid waste stream. Spent batteries should be disposed of by a qualified recycler or hazardous materials handler.

Contents

Safety Information	2
1 Introduction	6
1.1 Features	6
1.2 Appearance	7
1.3 Display Elements	7
1.4 Units of Measurement	8
2 Daily Operation	9
2.1 Activating the Gas Detector	9
2.2 Gas Alarms	9
2.3 Self-Diagnostic Tests	10
2.4 Non-Compliance Warnings	11
2.5 Navigating the Menu	11
2.6 Gas Readings and Parameters	12
Peak Readings	12
TWA Readings	12
STEL Readings	12
Resetting All Readings	12
Bump Test Schedule	13
Calibration Schedule	13
Alarm Thresholds	13
Firmware Version	13
Remaining Lifetime	13
2.7 Bump Test	13
2.8 Zeroing the Gas Detector	15
2.9 Calibration	16
2.10 Calibration Cap	17
2.11 Travel Mode	18
2.12 Low-Battery Alarm	19
2.13 Remaining Lifetime	19

3	User Preferences	20
3.1	Sensor Options	20
3.2	Behavior Options	21
3.3	Event Logs	22
3.4	Firmware Update	22
4	Maintenance	23
4.1	Cleaning the Detector	23
4.2	Replacing the Belt Clip	23
4.3	Replacing the Sensor Filter	23
5	Specifications	25
A	Warranty	27
A.1	Limited Warranty and Limitation of Liability	27
A.2	Contact Information	28
A.3	Warranty Registration	28
B	Detectable Combustible Gases	29
C	Standard Certifications	30
D	Label Information	32
D.1	cULus	32
D.2	IECEX	33
D.3	ATEX	33

Chapter 1

Introduction

1.1 Features

BW Clip4 is a portable gas detector, featuring the following:

- BW Clip4 detects these four gases.
 - Hydrogen sulfide (H₂S)
 - Carbon monoxide (CO)
 - Oxygen (O₂)
 - Combustible gases

NOTE

The target combustible gas is methane (CH₄).

- BW Clip4 can be used directly out of the box without any calibration or configuration.
- BW Clip4 is a low maintenance four-gas detector. It is designed to run for 2 years without having to be charged or replace sensors.

1.2 Appearance

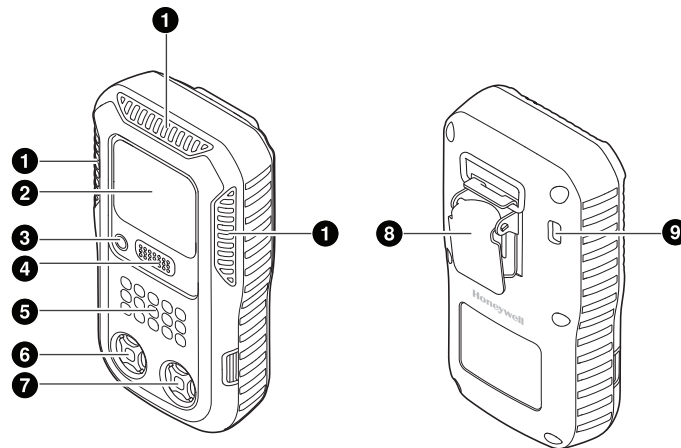





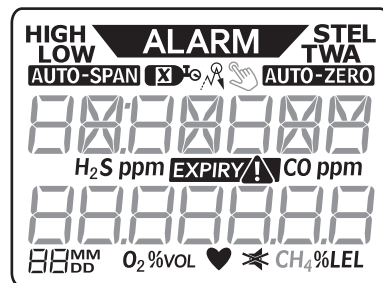



- | | |
|------------------------------------|---------------------------|
| 1) Alarm indicators | 2) Liquid crystal display |
| 3) Beeper | 4) Button |
| 5) Combustible gas sensor | 6) O ₂ sensor |
| 7) H ₂ S and CO sensors | 8) Belt clip |
| 9) Infrared transceiver | |

1.3 Display Elements



- ALARM** This symbol is displayed when a gas alarm occurs.
- HIGH** A gas concentration exceeds the high alarm threshold.
- LOW** A gas concentration exceeds the low alarm threshold.
- STEL** A STEL alarm occurs. See Gas Alarms on page 9.
- TWA** A TWA alarm occurs. See Gas Alarms on page 9.
-  This is displayed when user's input is needed. It could be either a single press or a press-and-hold.
- AUTO-SPAN** A span calibration is in progress or overdue.

-  A zero calibration is in progress.
-  A bump test or calibration is overdue.
-  A bump test or calibration fails.
-  Peak readings are recalled. See **Peak Readings** on page 12.
-  A functional error occurs. See **Non-Compliance Warnings** on page 11.
-  The remaining lifetime is less than 24 hours.
-  This is the remaining period of lifetime. See **Remaining Lifetime** on page 19.
-  This flashes as long as the detector works normally without any gas alarms and functional errors.
-  Stealth mode is enabled. In stealth mode, the detector generates only vibration when a gas alarm occurs.

1.4 Units of Measurement

- ppm** H₂S and CO concentrations are expressed in parts per million.
- %VOL** O₂ concentration is expressed in percent by volume.
- %LEL** Combustible gas concentration is expressed in percent by lower explosive limit.

NOTE

See **Detectable Combustible Gases** on page 29.

Chapter 2

Daily Operation

2.1 Activating the Gas Detector

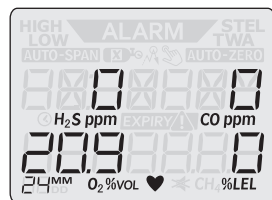

Activate the gas detector in a place where the air is clean and free of hazardous gases. In normal air, the concentration of oxygen is 20.9%.

To activate the gas detector, press and hold the button until a 3-second countdown is displayed, and then continue to hold until the countdown is completed. While it is activated, the detector simultaneously beeps, flashes and vibrates for a few seconds. Alarm thresholds are then displayed in turn. It may take the sensors up to one hour to stabilize. Finally, it displays all four gas concentrations and remaining life with the flashing heartbeat symbol ♥.

If the activation fails and subsequent attempts also fail, contact Honeywell Analytics or your distributor for technical assistance.

2.2 Gas Alarms

When a gas concentration is either over or under the specified limit according to the gas type, an alarm is generated. There are five types of gas alarms.

- Low-level alarm
- High-level alarm
- TWA alarm

- STEL alarm
- Over-limit alarm

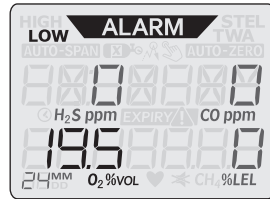

When a gas alarm occurs, the gas detector starts beeping, flashing and vibrating simultaneously and continues until the alarm condition is cleared. In addition, the display backlight turns on and the identifier for the responsible gas starts flashing.

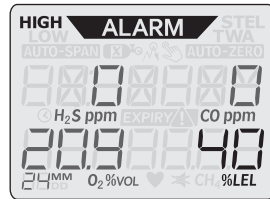

For high, STEL, and out-of-range alarms, the detector generates faster beeps, flashes and vibrations than for the other alarms, to draw more attention.

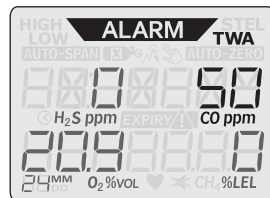

As a permissible exposure limit, a time-weighted average (TWA) is the acceptable average exposure over a specified period of time. The default period is 8 hours.

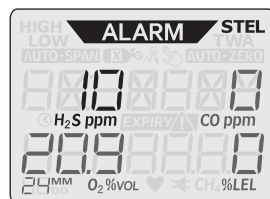

As a permissible exposure limit, a short-term exposure limit (STEL) is the acceptable average exposure over a short period of time as long as the TWA is not exceeded. The default duration is 15 minutes.

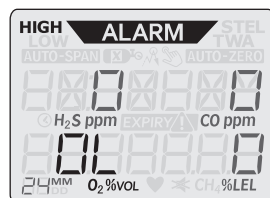

When a gas concentration is over the upper limit of the detection range, an over-limit (O.L.) alarm is generated.

If a gas alarm occurs, immediately identify what caused the alarm and take an appropriate action, such as moving to a safe place.

The default setting of gas alarms is non-latching but over-limit is latching.

2.3 Self-Diagnostic Tests

An activated gas detector automatically performs a self-diagnostic test every 24 hours. If a self-diagnostic test fails, the gas detector beeps, flashes and vibrates simultaneously until the user acknowledges it. In addition, the non-compliance symbol  appears with the corresponding error code, such as *bFlt Err*. Contact Honeywell Analytics or your

distributor for technical assistance.

2.4 Non-Compliance Warnings

The non-compliance warning symbol  appears flashing in the following situations:

- Failed self-diagnostic test
- Failed bump test or calibration
- Overdue bump test or calibration

When a functional error occurs, the gas detector tries to recover from it. If an error persists, contact Honeywell Analytics or your distributor for technical assistance.

2.5 Navigating the Menu

The main menu items are as follows:

- Information (*I NFO HOLd*)
- Bump test (*EQ BUMP HOLd*)
- Zero (*EQ ZERO HOLd*)
- Calibration (*EQ CAL HOLd*)
- Travel mode (*TRAVEL HOLd*)

Use the button to navigate the menu.

Get into the menu. Press the button twice in rapid succession, and the first menu item, *I NFO HOLd* is displayed.

Skip to the next menu item. Briefly press the button.

Choose a menu item. If the push symbol  appears flashing, it means that the menu item on the display includes available user actions. To choose the menu item, press and hold the button until a 3-second countdown is displayed, and then continue to hold until the countdown is completed.

Escape from the menu. Repeatedly press the button until *EXIT HOLd* appears, and then press and hold the button. Alternatively, simply wait for 60 seconds until the timeout is over.

2.6 Gas Readings and Parameters

Under the *INFO HOLD* menu, these items are provided on the display:

- Peak readings
- TWA readings
- STEL readings
- Resetting all readings
- Bump test schedule
- Calibration schedule
- Alarm thresholds
- Firmware version
- Remaining lifetime

Peak Readings

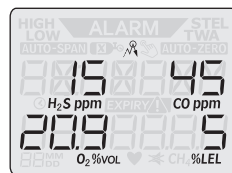

Peak readings are the highest detected concentrations since the last reset. To see the peak readings, choose *INFO HOLD* from the menu. The peak readings are displayed with the peak symbol .

TWA Readings

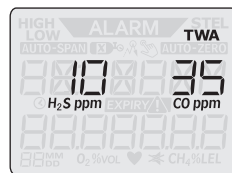

To see the TWA readings, get into the *INFO HOLD* menu. Skip ahead until **TWA** appears.

STEL Readings

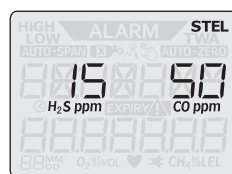

To see the STEL readings, get into the *INFO HOLD* menu. Skip ahead until **STEL** appears.

Resetting All Readings

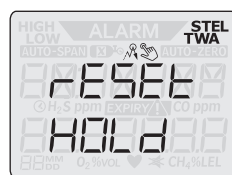

To reset peak, TWA and STEL readings, get into the *INFO HOLD* menu. Skip ahead until *RESET HOLD* appears with , **TWA** and **STEL**, and then press and hold the button.

Bump Test Schedule

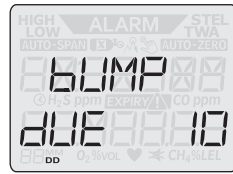

To see the number of remaining days until the next bump test, get into the *INFO HOLD* menu. Skip ahead to *BUMP*.

Calibration Schedule



To see the number of remaining days until the next calibration, get into the *INFO HOLD* menu item. Skip ahead to *CAL*.

Alarm Thresholds

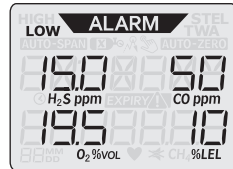

To see low alarm thresholds, get into the *INFO HOLD* menu. Skip ahead until the alarm symbol **ALARM** appears with **TWA**. Press the button again to see **STEL**, low and high alarm thresholds.

Firmware Version



To see the firmware version, get into the *INFO HOLD* menu. Skip ahead to *FW REV*.

Remaining Lifetime

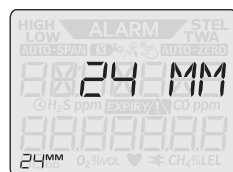

To see the remaining lifetime, get into the *INFO HOLD* menu. Skip ahead until the number of months or days of remaining lifetime appears.



2.7 Bump Test

Bump testing is the process of briefly exposing the gas sensors to a known concentration of calibration gas that is greater than the low alarm threshold. This is the only way to verify the proper operation of the gas detector.

NOTE

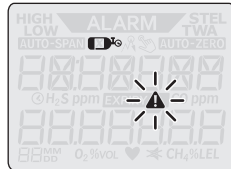
Honeywell Analytics provides a quad gas mixture for accurate bump tests and calibrations. Use the quad gas mixture rather than a single gas.



The cylinder symbol  appears with the flashing non-compliance symbol  when the bump test is overdue.

Use this procedure to do a bump test.



1. Connect a cylinder of calibration gas to the gas detector using the calibration cap. For details about how to use the calibration cap, see [Calibration Cap](#) on page 17.
2. Press the button twice in succession to get into the menu, skip ahead to *EO BUMP HOLD* by briefly pressing the button, and then press and hold the button to initiate a bump test.



3. *AVV TEST* appears as the detector beeps, flashes and vibrates to test the function of audible, visual and vibrating alarms. When *EO PASS HOLD* appears, press and hold the button for 1 second to acknowledge the test. To fail this test, briefly press the button.



4. When *APPLY 6AS* appears with a 60-second countdown, apply the calibration gas to the detector at a flow rate of 250 to 500 ml/min before the countdown is completed.

To cancel this bump test, briefly press the button.

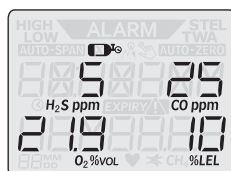

5. Verify that the gas reading is the same as expected.

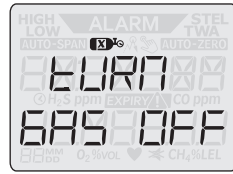

- When *EURN GAS OFF* appears, close the cylinder valve.

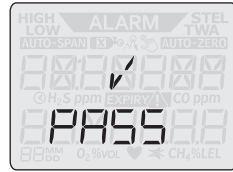

- When the bump test is successfully completed, *PASS* appears. If it fails, *FAIL* appears with the flashing non-compliance symbol .

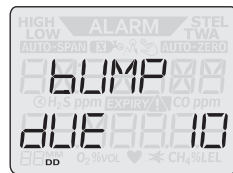

- BUMP DUE* appears with the number of remaining days until the next bump test.
- Remove the calibration cap from the detector.

If repeated attempts continue to fail, perform a calibration.

2.8 Zeroing the Gas Detector

Because usage environments vary, there are many factors that may affect the performance of the gas detector, including temperature and humidity changes as well as dust. If the ambient air is not clean, gas readings might be inaccurate. For optimal performance, zero the gas detector once every 24 hours or after changing of environmental conditions.

Make sure that the ambient air is clean and free of hazardous gases before starting this zeroing procedure.

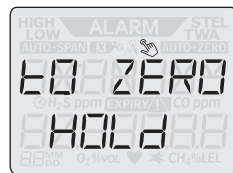

- Press the button twice in succession to get into the menu, skip ahead to *EO ZERO HOLD* by repeatedly pressing the button, and then press and hold the button to initiate a zeroing process.

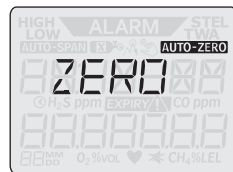

- ZERO* appears with the flashing zeroing symbol **AUTO-ZERO**. Wait until this zeroing process is completed.





- When the zeroing process is successfully completed, *PASS* appears.

If repeated attempts continue to fail, contact Honeywell Analytics or your distributor for technical assistance.

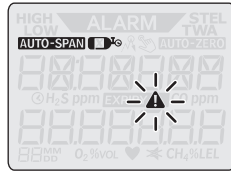
2.9 Calibration



The calibration symbol **AUTO-SPAN** and cylinder symbol  appear with the flashing non-compliance symbol  when calibration is overdue.

Make sure that the ambient air is clean and free of hazardous gases before starting this calibration procedure.

NOTE

Honeywell Analytics provides a quad gas mixture for accurate bump tests and calibrations. Use the quad gas mixture rather than a single gas.



1. Press the button twice in succession to get into the menu, skip ahead to **CAL HOLD** by repeatedly pressing the button, and then press and hold the button to initiate a calibration.

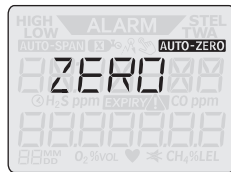

2. **ZERO** appears with the flashing zeroing symbol **AUTO-ZERO**. Wait until this zeroing process is completed.

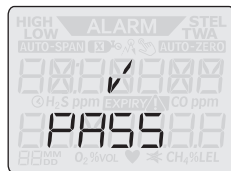

3. When the zeroing process is successfully completed, **PASS** appears. If it fails, **FAIL** appears with the flashing non-compliance symbol .

4. Connect a cylinder of calibration gas to the gas detector using the calibration cap. For details about how to use the calibration cap, see **Calibration Cap** on page 17.



5. When **APPLY GAS** appears with a 60-second countdown, apply the calibration gas to the detector at a flow rate of 250 to 500 ml/min before the countdown is completed.

To cancel this calibration, briefly press the button.

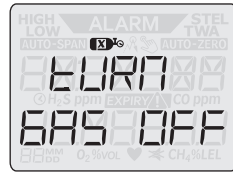

- When *EURN GAS OFF* appears, close the cylinder valve.

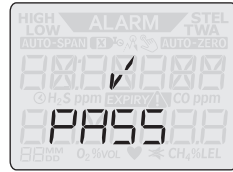

- When the calibration is successfully completed, *PASS* appears. If it fails, *FAIL* appears with the flashing non-compliance symbol **▲**.

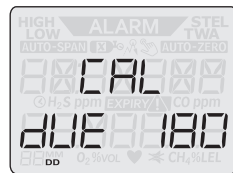

- CAL DUE* appears with the number of remaining days until the next calibration.
- Remove the calibration cap from the detector.

If repeated attempts continue to fail, contact Honeywell Analytics or your distributor for technical assistance.

2.10 Calibration Cap

The calibration cap, which is provided as part of the package, is required to do a bump test or calibration. Use this method to apply calibration gas to the gas detector.

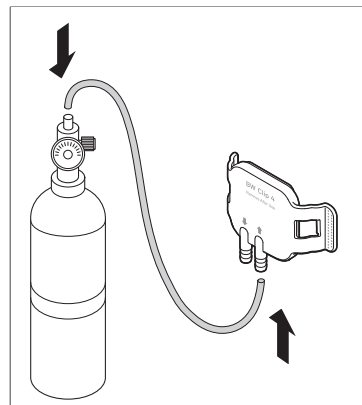

- Connect a tube from a cylinder of calibration gas to the calibration cap's right spigot.

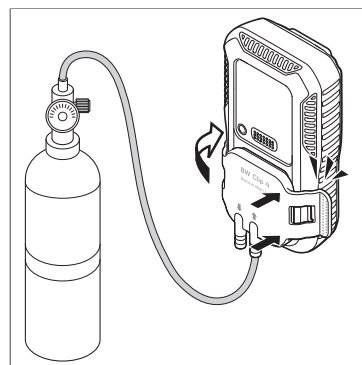

- To attach the calibration cap to the gas detector, hook the cap's left clip to the corresponding groove of the detector and snap the right clip into place.

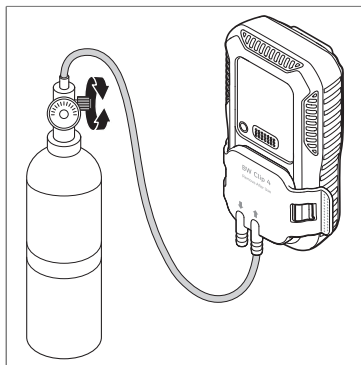

3. When *APPLY GAS* appears on the display of the detector, open the cylinder valve by turning the pressure regulator knob counterclockwise.
4. When *TURN GAS OFF* appears, close the cylinder valve by turning the pressure regulator knob clockwise.

⚠ CAUTION

Make sure that the gas cylinder meets either of these pressure requirements:

- Disposable cylinder: 0 to 1000 psig/70 bar
- Refillable cylinder: 0 to 3000 psig/207 bar

Do not use an expired gas cylinder.

2.11 Travel Mode

BW Clip4 allows users to turn on Travel Mode when needed. In this mode:

- All alarms are disabled.
- Event logs as well as accumulation of TWA/STEL are suspended.
- Menu navigation is disabled.
- The 2-year countdown clock continues to count down.

The user can immediately return to the normal monitoring mode by holding the button down for 3 seconds.

Entering and exiting travel mode will be documented in the BW Clip4 unit's event logger.



1. Press the button twice in succession to get into the menu, skip ahead to *TRAVEL HOLD* by repeatedly pressing the button, and then press and hold the button.

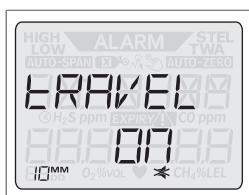

2. When successfully activated, a short alarm sound beeps and *TRAVEL ON* appears on the display.

Exit Travel Mode

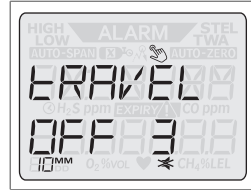

Press and hold the button until a 3-second countdown is displayed, and then press and hold until the countdown is completed.

Low Battery in Travel Mode

The non-compliance symbol and remaining life time flash under a low battery condition in travel mode. Please contact Honeywell Analytics or your distributor for technical assistance.

2.12 Low-Battery Alarm

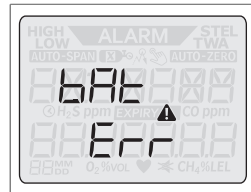

BW Clip4 is designed to run for 2 years without having to be charged. Within 2 years operating time, battery could be discharged depending on the actual use case. BW Clip4 display will show the alarm **bAtE Err** and BW Clip4 will be turned off automatically 10 minutes later. Please contact Honeywell Analytics or your distributor for technical assistance.

2.13 Remaining Lifetime

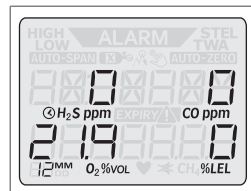

When the remaining lifetime is more than 3 months, it is displayed in the unit of month.

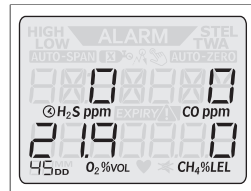

When the remaining life time is 3 months or less, it is displayed in the unit of day.

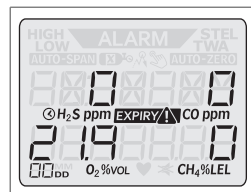

When the remaining life time is 24 hours or less, **00_{DD}** is displayed with **EXPIRY!**.

BW Clip4 will automatically shut itself off at the end of its lifetime.

Chapter 3

User Preferences

All of the parameters and options can be configured using the Fleet Manager II desktop application. An IntelliDox docking station is required to connect a BW Clip4 unit to Fleet Manager II. The BW Clip4 communicates with an IntelliDox using infrared signals, and the IntelliDox is connected to the Fleet Manager II computer via a USB or network cable. For more information, refer to the IntelliDox manual and Fleet Manager II manual.

3.1 Sensor Options

As for each sensor, these parameters and options are available.

- **Sensor Disabled:**
Disable an unnecessary gas sensor.
- **Calibration Gas Conc:**
Define the gas concentration for calibration.
- **Low Alarm:**
Define the threshold at which a low-level alarm is triggered.
- **High Alarm:**
Define the threshold at which a high-level alarm is triggered.
- **TWA Alarm:**
Define the threshold at which a TWA alarm is triggered. This parameter is available only for H₂S and CO.
- **STEL Alarm:**
Define the threshold at which a STEL alarm is triggered. This parameter is available only for H₂S and CO.
- **Calibration Interval:**
Define how often a calibration should be done.

- **Bump Interval:**
Define how often a bump test should be done.
- **STEL interval:**
Define the period of time after which a STEL alarm is triggered. This parameter is available only for H₂S and CO. The available range is 5 to 15 minutes.
- **Display Decimal:**
Determine whether to express as an integer or tenths decimal. This parameter is available only for H₂S.
- **Low Alarm Trigger:**
This parameter is available only for O₂. Determine whether to generate a low-level alarm when the oxygen concentration is above the normal range or when it is the reverse.
- **High Alarm Trigger:**
This parameter is available only for O₂. Determine whether to generate a high-level alarm when the oxygen concentration is above the normal range or when it is the reverse.

3.2 Behavior Options

These behavior options are available.

- **Travel Mode:**
With this option enabled, the travel menu item becomes visible and usable.
- **Stealth Mode:**
With this option enabled, the gas detector only vibrates without beeping and flashing when an alarm occurs.
- **Alarm Latch:**
With this option enabled, when an alarm occurs, the detector continues beeping, flashing and vibrating for a specified period of time even after the alarm condition is cleared. To acknowledge a latched alarm, press the button.
- **Time zone:**
Specify the time zone where the detector is used.
- **Automatically adjust clock for Daylight Savings Time:**
Determine whether to use daylight saving time.

- **Spring Start Time:**

For daylight saving time, specify the date and time when the spring starts.

- **Fall End Time:**

For daylight saving time, specify the date and time when the fall ends.

3.3 Event Logs

The detector stores the last 70 events that occurred, including peak readings and bump tests. Event logs contain the following:

- The detector's serial number, sensor type and remaining lifetime
- The total number of events that have occurred
- Alarm thresholds
- The time elapsed since an alarm occurred
- The time during which the alarm continued

Use Fleet Manager II via an IntelliDox station to transfer from the detector to a computer.

3.4 Firmware Update

The BW Clip4 firmware can be updated using an IntelliDox docking station and flash drive. For more information, refer to the IntelliDox manual.

Chapter 4

Maintenance

4.1 Cleaning the Detector

Clean the detector using a soft cloth with water-based or non-alcoholic cleaner. Other types of cleaners, solvents and lubricants can contaminate and cause permanent damage to the detector sensors.

4.2 Replacing the Belt Clip

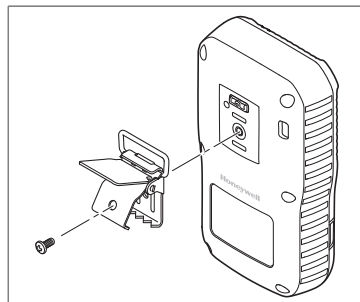

If the belt clip is damaged or loose, replace it with a new one. Insert a screwdriver through the hole in the clamp and loosen the screw to detach the clip. Put a new clip in place and fasten it.

4.3 Replacing the Sensor Filter

If the sensor filter is dirty or damaged, please replace it with a new one.

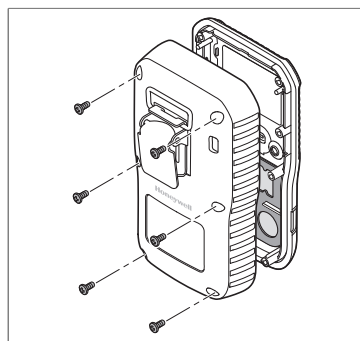

1. Loosen the six screws on the back of the detector to separate the front panel.

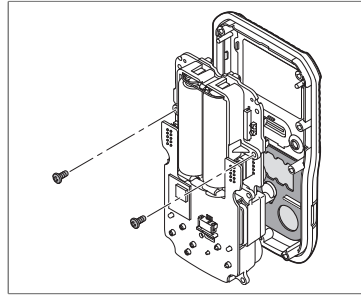

2. Loosen the two screws on the PCB to remove it from the front panel.

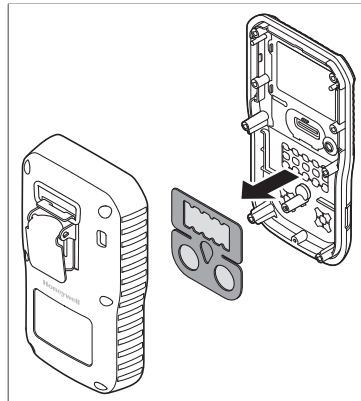

3. Remove the sensor filter from the inside of the front panel.
4. Put a new filter in place.
5. Reassemble the detector in the reverse order.

 **CAUTION**

Improper re-assembly of the BW Clip4 detector could lead to damage and loss of ingress protection.

Chapter 5

Specifications

Dimensions and Weight

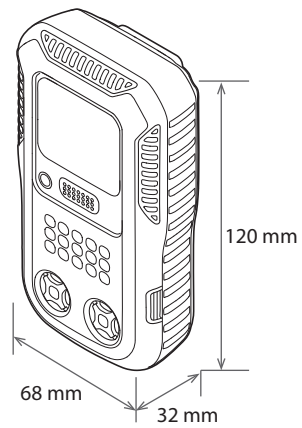

Length	68 mm
Depth	32 mm
Height	120 mm
Weight	233 g

Operating Environment

Best performance ambient temperature	-20 to 50°C
Intrinsic safety ambient temperature	-40 to 55°C
Humidity	0 to 95% (non-condensing)

Specifications

Detection range

H ₂ S	0 to 100.0 ppm with 1/0.1 increments
CO	0 to 1000 ppm with 1 increments
O ₂	0 to 25.0% Vol with 0.1 increments
Combustible gases	0 to 100% LEL (or 0 to 5.0% Vol) with 1 increments

Life

Shelf Life	Six (6) months before activation
Maximum operating life	2 years after activation, assuming 2 minutes of alarm time per day.
Event Logging	Maximum 70 Events

Alarm Setpoints

Use Fleet Manager II via an IntelliDoX station to adjust alarm setpoints. For more information, refer to the operator manuals for Fleet Manager II software or more and the IntelliDoX automatic test and calibration station.

Audible alarm	≈ 95 dB at 30 cm (1 ft.)
Visual alarm	Flashing, wide-angled alarm lens with red LEDs plus alarm LCD readout
Display	Alphanumeric liquid crystal display (LCD)

Sensor Type

H ₂ S and CO	Single plug-in electrochemical cell
O ₂	Lead oxide
Combustibles (LEL)	LED Infrared
Battery	Lithium, non-replaceable

Waterproof

Identification code for protection	IP68
------------------------------------	------

Appendix A

Warranty

A.1 Limited Warranty and Limitation of Liability

Honeywell Analytics warrants the product to be free from defects in material and workmanship under normal use and service over the operational life of the device. This warranty extends only to the sale of new and unused products to the original buyer. Honeywell Analytics' warranty obligation is limited, at Honeywell Analytics' option, to refund of the purchase price, repair or replacement of a defective product that is returned to a Honeywell Analytics authorized service center within the warranty period. In no event shall Honeywell Analytics' liability hereunder exceed the purchase price actually paid by the buyer for the Product. This warranty does not include:

- fuses, disposable batteries or the routine replacement of parts due to the normal wear and tear of the product arising from use;
- any product which in Honeywell Analytics' opinion, has been misused, altered, neglected or damaged, by accident or abnormal conditions of operation, handling or use;
- any damage or defects attributable to repair of the product by any person other than an authorized dealer, or the installation of unapproved parts on the product.

The obligations set forth in this warranty are conditional on:

- proper storage, installation, calibration, use, maintenance and compliance with the product manual instructions and any other applicable recommendations of Honeywell Analytics;
- the buyer promptly notifying Honeywell Analytics of any defect and, if required, promptly making the product available for correction. No goods shall be returned to Honeywell Analytics until receipt by the

buyer of shipping instructions from Honeywell Analytics;

- the right of Honeywell Analytics to require that the buyer provide proof of purchase such as the original invoice, bill of sale or packing slip to establish that the product is within the warranty period.

THE BUYER AGREES THAT THIS WARRANTY IS THE BUYER'S SOLE AND EXCLUSIVE REMEDY AND IS IN LIEU OF ALL OTHER WARRANTIES, EXPRESS OR IMPLIED, INCLUDING BUT NOT LIMITED TO ANY IMPLIED WARRANTY OF MERCHANTABILITY OR FITNESS FOR A PARTICULAR PURPOSE. HONEYWELL ANALYTICS SHALL NOT BE LIABLE FOR ANY SPECIAL, INDIRECT, INCIDENTAL, OR BASED ON CONTRACT, TORT OR RELIANCE OR ANY OTHER THEORY.

Since some countries or states do not allow limitation of the term of an implied warranty, or exclusion or limitation of incidental or consequential damages, the limitations and exclusions of this warranty may not apply to every buyer. If any provision of this warranty is held invalid or unenforceable by a court of competent jurisdiction, such holding will not affect the validity or enforceability of any other provision.

A.2 Contact Information

Australia/New Zealand: +613 9464 2770

Brazil: +55 11 3309 1030

Canada: +1-800-663-4164

China: +86-21-5855-7305

Europe: +41 44 943 4380

India: +91 1214 4752700

Japan: +03-6730-7320

Korea: +82-2-69090300

Latin America (Spanish): +571 3904878

Middle East: +971 4 4505800

Russia/CIS: +7 495 796 9800

Singapore: +65-65803776

Taiwan: +886-3-5169284

USA: +1-888-749-8878

For more contact information, visit www.honeywellanalytics.com.

A.3 Warranty Registration

www.honeywellanalytics.com/support/product-registration

Appendix B

Detectable Combustible Gases

Gas ¹	Expected response at 20% LEL target gas ²
Methane	20% LEL
Propane	15% LEL to 45% LEL
Butane	15% LEL to 35% LEL
Pentane	15% LEL to 45% LEL
Hexane	8% LEL to 28% LEL
Methanol/Ethanol ³	6% LEL to 26% LEL
Hydrogen	No response
Acetylene	No response

¹For any gases not listed, please contact Honeywell Analytics to find the best solution for your application.

²The BW Clip4 LEL sensor is optimized to see methane. While the unit can detect and respond to the other combustible gases listed in the above table, the accuracy of the readings may be in-consistent. If the primary need is to detect a specific combustible gas other than methane, please contact Honeywell Analytics to discuss an alternative product.

³Please use caution when using the BW Clip4 around Methanol and/or Ethanol. The BW Clip4 CO sensor may become inhibited by prolonged exposure to concentrations of Methanol and/or Ethanol thus causing the unit to alarm. This condition can last up to 12 hours before the CO sensor recovers to normal levels.

Appendix C

Standard Certifications

The BW Clip4 gas detector is in conformity with the following standards:

ANSI/UL 61010-1-2016, 3rd ed
ANSI/UL 60079-0-2013 (R2017)
ANSI/UL 60079-11-2013 (R2018)
ANSI/UL 913-2015

CSA C22.2 No. 0-10 (R2015)
CSA C22.2 No. 152-M1984 (R2016)¹
CSA C22.2 No. 60079-0-15 (R2018)
CSA C22.2 No. 60079-11-14 (R2018)
CSA C22.2 No. 61010-1-12 (R2017), 3rd ed

EN 60079-0:2018
EN 60079:11:2012
IEC 60079-0:2017 ed. 7
IEC 60079-11:2011 ed. 6

¹BW Clip4's flammable sensor was evaluated for CSA C22.2 No.152-M1984 (R2016). The evaluation was valid only with the calibration flow rate 300 ml/min and CH₄ gas. The other flow rate for calibration and other flammable gases are not the scope of CSA C22.2 No.152-M1984(R2016). In accordance with CSA C22.2 No. 152-M1984 (R2016), the adjustable alarm point shall not exceed 60% LEL. BW Clip4's flammable sensor operational limitations are:

- Storage temperature: -40 to +55°C
- Operational temperature: -40 to +55°C (Intermittent)
- Humidity: 0 to 95% R.H. (non-condensing)
- Air velocity: lower than 300 m/min

If BW Clip4's flammable sensor is suspected to be damaged by aggressive substances, please Perform Bump Test and Calibration per this manual.

CSA (CSA18CA70205765)

Classified by CSA to both US and Canadian Standards as intrinsically safe for Class I, Division 1, Group A, B, C, D and Class I, Zone 0, Group IIC, -40°C ≤ Tamb ≤ +55°C.

ATEX (Sira 18ATEX2287X)

II 1G, Ex ia IIC T4 Ga, -40°C ≤ Tamb ≤ +55°C

CE

European Conformity

EU Declaration of Conformity

www.honeywellanalytics.com

IECEX (IECEX SIR 18.0075X)

Ex ia IIC T4 Ga, $-40^{\circ}\text{C} \leq T_{\text{amb}} \leq +55^{\circ}\text{C}$

Appendix D

Label Information

D.1 cCSAus

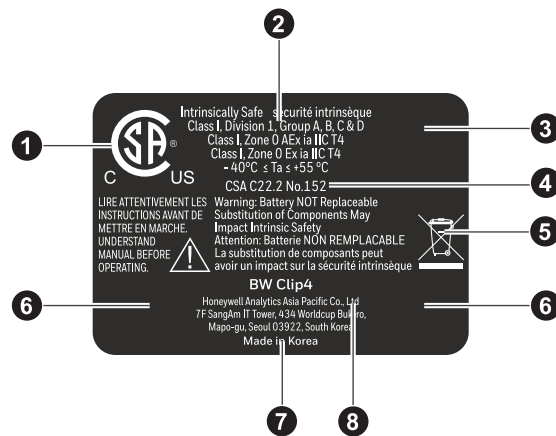

-
- 1) cCSAus marking
 - 2) US and Canadian explosion-proof protection marking
 - 3) Reserved for other certification marking
 - 4) Canadian flammable gas performance marking
 - 5) WEEE marking
 - 6) Reserved for serial number and 2D barcode
 - 7) Country of origin
 - 8) Address of manufacturer
-

D.2 IECEX

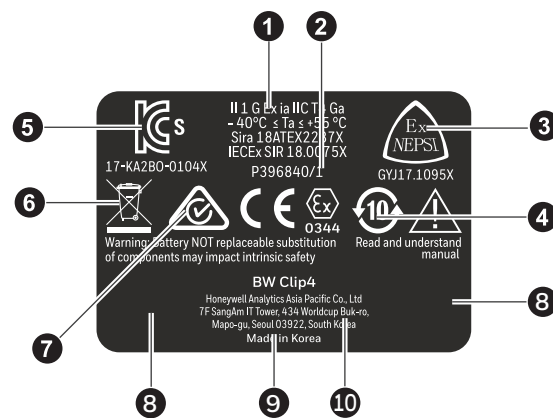

- 1) IECEX explosion-proof protection marking and certification number
- 2) Indian explosion-proof marking
- 3) Chinese explosion-proof marking
- 4) Chinese EPUP marking
- 5) Korean explosion-proof marking
- 6) WEEE marking
- 7) Australia C-TICK marking
- 8) Reserved for serial number and 2D barcode
- 9) Country of origin
- 10) Address of manufacturer

D.3 ATEX

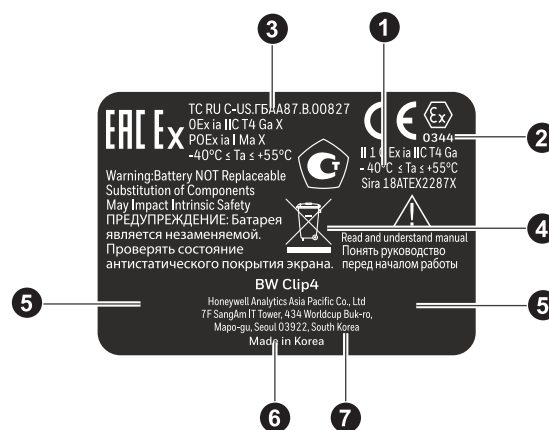

- 1) ATEX explosion-proof protection marking and certification number
- 2) ATEX QAN notified body number
- 3) Russian explosion-proof marking
- 4) WEEE marking
- 5) Reserved for serial number and 2D barcode
- 6) Country of origin
- 7) Address of manufacturer

Honeywell

THE POWER OF **CONNECTED**

Keep this manual for later use.

3102M5025-EN-V3 BW Clip4 Operator Manual
© 2019 Honeywell Analytics