

ACTEON 5000

Digital multi-parameter transmitter

User manual



CONTENTS

1. GENERAL	4
1.1 Safety instructions.....	4
1.2 Labeling	4
2. DESCRIPTION OF THE EQUIPMENT	5
2.1 ACTEON 5000 transmitter.....	5
2.1.1 General description.....	5
2.1.2 Technical characteristics.....	5
2.2 Digital sensors.....	6
2.2.1 OPTOD sensor: dissolved oxygen (optical technology).....	6
2.2.2 PHEHT sensor: pH and temperature.....	7
2.2.3 EHAN sensor: Redox and temperature.....	8
2.2.4 NTU sensor: Turbidity in NTU-mg/l.....	9
2.2.5 C4E sensor: 4-electrode conductivity.....	10
2.2.6 CTZN sensor: inductive conductivity.....	11
2.2.7 VB5 sensor: Sludge Blanket detection.....	12
2.2.8 MES5 sensor: Sludge Blanket detection, Suspended Solid, Turbidity.....	13
2.2.9 StacSense Sensor : parameter SAC254 and equivalent values of CODEq, BODEq, TOCEq and Turbidity eq.....	14
3. INSTALLATION	16
3.1 Description and mounting of the controller.....	16
3.1.1 Description of the front face.....	16
3.1.2 Equipment required.....	16
3.1.3 Outline drawings of the ACTEON 5000.....	17
3.2 Electrical connections.....	18
3.2.1 Safety instructions – Installation.....	18
3.2.2 Description of the wiring.....	19
4. USER INTERFACE	22
4.1 Home screen.....	22
4.2 Navigation icons.....	23
5. SETTING UP	24
5.1 Initial start-up.....	24
5.2 Installation of digital sensors.....	25
5.3 Selection of the parameters.....	25
6. PROGRAMMING	28
6.1 Main menu.....	28
6.2 Description of the menus.....	28
6.2.1 Configuring the digital inputs.....	28
6.2.2 Configuring the On/Off inputs.....	35
6.2.3 Configuring the Analog inputs.....	36
6.2.4 Configuring the ACTEON 5000.....	40
6.2.5 Configuring the Analog outputs.....	41
6.2.6 Configuring the relay outputs.....	44
6.2.7 Configuring the Recording output.....	48
6.2.8 Configuration of digital outputs: Ethernet or RS485 MODBUS slave series.....	48

7. USING THE MOTORIZED CLEANING ACCESSORY HYDROCLEAN-P.....	51
8. MAINTENANCE	52
8.1 Maintaining the transmitter:.....	52
8.2 Maintenance of digital sensors:.....	53
8.2.1 OPTOD sensor.	53
8.2.2 NTU sensor: Turbidity.	55
8.2.3 PHEHT sensor: pH/Temperature.....	57
8.2.4 ORP sensor: REDOX/Temperature.....	58
8.2.5 C4E sensor: 4-electrode conductivity.	59
8.2.6 CTZN sensor: Inductive conductivity.	60
8.2.7 VB5 – MES 5 sensor: Sludge blanket detection – Sludge blanket detection/Suspended Solid/Turbidity.	61
8.2.8 StacSense probe.	62
9. TROUBLESHOOTING	64

1. General

1.1 Safety instructions



In order to maintain and ensure the good working order of the device, users must comply with the safety precautions and warnings featured in this manual.

Assembly and activation:

- Assembly, electrical connection, activation, operation and maintenance of the measuring system must only be carried out by specialist personnel authorized by the user of the facilities.
- Trained personnel must be familiar with and comply with the instructions in this manual.
- Make sure the power supply complies with the specifications on the nameplate before connecting the device.
- A clearly-labeled power switch must be installed near the device.
- Check all connections before turning the power on.
- Do not attempt to use damaged equipment: it may represent a hazard and should be labeled as faulty.
- Repairs must only be carried out by the manufacturer or by AQUALABO's after-sales service department.

1.2 Labeling

Prior to any installation or start-up operation, check all the labels and symbols affixed to the measurement device.

	<p>This symbol indicates there is a risk of electric shock or electrocution associated with the use of the device.</p>
	<p>This symbol indicates that the measuring device cannot be disposed of as conventional waste.</p>

➤ Label on outside of device:



The ACTEON 5000 label on the right-hand face indicates the required power supply and the device's serial number.

2. Description of the equipment

2.1 ACTEON 5000 transmitter.

2.1.1 General description.

The ACTEON 5000 digital transmitter can be connected to two digital sensors in the PONSEL MESURE range to monitor the following parameters: pH, redox, temperature, dissolved oxygen (using optical technology), conductivity, salinity, turbidity (NTU, mg /L), Suspended Solid, Sludge blanket detection, COD, BOD, TOC (STACSENSE)....

The values measured are displayed and transmitted using analog or digital technology. The preconfigured regulation functions can be used to optimize the control of processes.

The ACTEON 5000 is used in combination with a wide range of interference-resistant digital sensors, offering pre-amplification features built into the sensor and digital signal processing. All the data regarding the calibration, history, users and measurements is processed directly within the sensor, thus delivering very high levels of traceability and enhancing the reliability of the measurements.

2.1.2 Technical characteristics.

Software and functionalities	
Digital sensor input	2 RS-485 digital sensor inputs
2 analog outputs	Choice of 2 programmable parameters depending on the sensor connected Programming in mode PI, PID
2 relay/digital outputs	Can be set to NO/NC Setpoint: the measurement range (hysteresis/direction) and activation time can both be selected, Control of the external cleaning system Equipment sensor fault alarm output
Digital output	Modbus RTU Ethernet TCP IP
Data recording	Internal flash memory Frequency recording: 1-120 mn Recording journal of events, measure sensors.
Atmospheric pressure sensor	For oxygen pressure compensation

Technical characteristics of the transmitter	
Display	Backlit LCD graphic touch screen – Size: 95x54 mm
Analog outputs	0/4.00 – 20.00 mA with galvanic isolation Max. load 250 Ω
Relay outputs	6 A /250 V
Operating conditions	Range of operating temperatures: -15 °C to 50 °C Storage/shipping temperature -15 °C to 50 °C
Power supply/Electrical protection	100-240 V ac/dc 50-60 Hz - Option: 9-28 V dc/dc - Electrical protection: complies with EN 61010-1: 2010

Casing	
Dimensions (WxHxD)	213 x 185 x 84 mm
Weight	950 g
Material	Grey ABS
Ingress protection rating	IP 65
Front face	Non-reflective polyester

2.2 Digital sensors.

The digital sensors in the PONSEL range are equipped with galvanic isolation and can perform digital signal processing to optimize the reliability of the measurements and data sent to the ACTEON 5000 terminal.

All the data regarding the calibration, calibration history, users and measurements is processed directly within the sensor and transmitted via a Modbus RS-485 link.

The range of digital sensors can be used to measure a variety of parameters: temperature, dissolved oxygen, pH, redox potential, conductivity (4-electrode or inductive measurement principle), turbidity and suspended solids.

2.2.1 OPTOD sensor: dissolved oxygen (optical technology).

The OPTOD dissolved oxygen sensor applies the luminescence-based optical measurement technology and measures reliably and accurately without requiring calibration.

With no consumables or maintenance required, the OPTOD sensor gives an immediate return on the investment. The only intervention required is to replace the DO disk every two years.

Since it does not consume oxygen, the OPTOD sensor can be used in all media; even when there is a very weak flow of water.

The body is made of passivated 316 L stainless steel or **Titanium** for applications in corrosive media.

Measurements	
Measurement principle	Luminescence-based optical measurement
Measurement ranges	0.00 to 20.00 mg/L 0.00 to 20.00 ppm 0-200%
Resolution	0.01
Accuracy	+/- 0.1 mg/L +/- 0.1 ppm +/- 1 %
Response time	90% of the value in less than 60 seconds
Recommended measurement frequency	> 5 s
Water movement	No circulation required
Temperature compensation	Via an NTC thermistor
Storage temperature	- 10 °C to + 60 °C
Temperature measurement range	0 °C to 50 °C
Accuracy	+ /- 0.5 °C
Signal interface	Modbus RS-485 (or SDI-12)
Power supply for sensor	5 to 12 volts
Power consumption	Standby: 25 µA When sending via RS-485 (1 measurement/second): 4.4 mA When sending via SDI-12 (1 measurement/second): 7.3 mA Current pulse: 100 mA Warm-up time: 100 mS
Sensor	
Dimensions	Diameter: 25 mm; Length not including cable: 146 mm
Weight	Stainless steel version: 450 g (sensor + 3 m of cable) Titanium version: 300 g (sensor + 3 m of cable)
Material in contact with the medium	Passivated 316L stainless steel. New: Titanium body
Maximum pressure	5 bar
Cable	9-wire shielded conductor, uncoated-strand polyurethane sleeve
Ingress protection rating	IP68

2.2.2 PHEHT sensor: pH and temperature.

This PONSEL sensor is fitted with an Ag/AgCl reference electrode, used to measure pH and redox, in a "PLASTOGEL"® KCl-saturated plasticized electrolyte.

The Plastogel® electrolyte is in direct contact with the external environment without interposition of capillary or porous material. There is therefore no risk of fouling or deactivating the reference electrode.

The electrode used to measure the pH is a pH-sensitive glass bulb (made from special glass) welded to the end of a crystal tube, and the electrode for Redox measurements is a platinum disk.

Temperature: measured by an NTC thermistor inserted in a stainless steel sheath.

pH measurement	
Measurement principle (pH)	pH/reference combined electrode: special glass, Ag/AgCl reference. Gel (KCl) electrolyte
Measurement range	0 – 14 pH
Resolution	0.01 pH
Accuracy	+/- 0.1 pH
Measurement of the Redox	
Measurement principle (Redox)	Redox/reference combined electrode: Platinum disk, Ag/AgCl reference. Gel (KCl) electrolyte
Measurement range	- 1000.0 to + 1000.0 mV
Resolution	0.1 mV
Accuracy	± 2 mV
Response time	< 5 s
Temperature measurement	
Measurement principle (T°C)	NTC thermistor
Operating temperature	0.00 °C to + 50.00 °C
Resolution	0.01 °C
Accuracy	± 0.5 °C
Response time	< 5 s
Storage temperature	0 °C to + 60 °C
Ingress protection rating	IP 68
Signal interface	Modbus RS-485 as standard and SDI-12 as an option
Measurement refresh rate	< 1 second maximum
Power supply for sensor	5 to 12 volts
Power consumption	Standby: 25 µA When sending via RS-485 (1 measurement/second): 3.9 mA When sending via SDI-12 (1 measurement/second): 6.8 mA Current pulse: 500 mA
Sensor	
Dimensions of fitted sensor	Lower part: 21 mm in diameter; 92 mm long, Upper part: 27 mm in diameter; 103 mm long, Length of fitted sensor: without cable gland 210 mm; Length with cable gland: 260 mm.
Weight	350 g (sensor + cable)
Material in contact with the medium	PVC, POM-C, special pH glass, platinum, polyurethane
Maximum pressure	5 bar
Cable/connection hardware	9-wire shielded conductor, uncoated-strand polyurethane sleeve

2.2.3 EHAN sensor: Redox and temperature.

The PONSEL sensor incorporates a reference electrode, used for ORP measurements, such as Ag / AgCl in saturated KCl electrolyte plasticized "PLASTOGEL" ®.

The electrolyte "PLASTOGEL" ® communicates directly with the external environment without interposition of capillary or porous. So there is no risk of clogging or defusing the reference.

The measuring electrode is in platinum (3,5mm²) presented in sealed ring on a glass rod and is for in-situ measurements continuously

Temperature: measures via CTN.

ORP Measure	
Principle of ORP measure	Combination Electrode (ORP/reference) platinum ring, Reference Ag/AgCl. Gelled electrolyte (KCl)
Range of measures	- 1000.0 to + 1000.0 mV
Resolution	+/- 0.1 mV
Precision	+/- 10 mV
Answer time	< 90 s
Temperature measurement	
Principle of measure T°C	CTN
Temperature	0,00 °C to + 50.00°C
Resolution	0.01 °C
Precision	+/- 0.5 °C
T90	< 300 s
Temperature of storage	0°C to + 60°C
Protection scale	IP 68
Interface signal	Modbus RS-485 standard and SDI-12 in option
Refresh rate measurement	Maximum < 1 second
Sensor power	5 to 12 volts
Consumption	Standby : 25 µA Average RS485 (1 measure/second) : 20 mA Pulse current : 500 mA Heating time : 100 mS
Sensor	
Dimensions of sensor mounted	Mounted sensor length: gland (262 mm) not included ; Length with gland : 324 mm.
Weight	350 g (sensor + cable)
Material in contact with the environment	PVC, POM-C,platinum, Polyurethane
Maximum Pression	5 bars
Cable/ connection	9-wire shielded conductor, uncoated-strand polyurethane sleeve

2.2.4 NTU sensor: Turbidity in NTU-mg/l.

The measuring principle is based on nephelometry: a diode emits infrared light (850 nm) and an IR receiving diode, set to one side at an angle of 90°, detects the amount of scattered light (standardized measurement). The sensor can be calibrated using a Formazine standard.

This very economical optical technology requires very little maintenance and no consumables.

Measurements					
Measurement principle	Scattering of IR at 90°				
Measurement ranges	<table border="1"> <tr> <td>0 to 4,000 NTU in 5 ranges:</td> <td>0 to 4,500 mg/L range</td> </tr> <tr> <td> <ul style="list-style-type: none"> ▪ 0 - 50 NTU ▪ 0 – 200 NTU ▪ 0 – 1,000 NTU ▪ 0 – 4,000 NTU ▪ AUTO range </td> <td> Calibration: 0-500 mg/L range, as per standard NF EN 872 range >500 mg/l as per standard NF T 90 105 2 </td> </tr> </table>	0 to 4,000 NTU in 5 ranges:	0 to 4,500 mg/L range	<ul style="list-style-type: none"> ▪ 0 - 50 NTU ▪ 0 – 200 NTU ▪ 0 – 1,000 NTU ▪ 0 – 4,000 NTU ▪ AUTO range 	Calibration: 0-500 mg/L range, as per standard NF EN 872 range >500 mg/l as per standard NF T 90 105 2
0 to 4,000 NTU in 5 ranges:	0 to 4,500 mg/L range				
<ul style="list-style-type: none"> ▪ 0 - 50 NTU ▪ 0 – 200 NTU ▪ 0 – 1,000 NTU ▪ 0 – 4,000 NTU ▪ AUTO range 	Calibration: 0-500 mg/L range, as per standard NF EN 872 range >500 mg/l as per standard NF T 90 105 2				
Resolution	from 0.1 to 1, set automatically as a function of the range				
Accuracy	< 5% of the NTU value recorded				
Response time	< 5 s				
Operating temperature	0 °C to + 50 °C				
Temperature measurement	Via an NTC thermistor				
Storage temperature	-10 °C to + 60 °C				
Signal interface	Modbus RS-485 as standard and SDI-12 as an option				
Maximum refresh rate	< 1 second				
Power supply to sensor	5 to 12 volts				
Power consumption	Standby: 40 µA / Warm-up time: 100 mS/ Current pulse: 500 mA When sending via RS-485 (1 measurement/second): 820 µA When sending via SDI-12 (1 measurement/second): 4.2 mA				
Sensor					
Dimensions	Diameter: 27 mm; Length not including cable: 170 mm				
Weight	300 g (with 3 meters of cable)				
Materials	PVC, POM-C, PMMA, Polyamide				
Maximum pressure	5 bar				
Cable/connection hardware	9-wire shielded conductor, uncoated-strand polyurethane sleeve				
Ingress protection rating	IP68				

2.2.5 C4E sensor: 4-electrode conductivity.

The operation of the sensor is based on 4-electrode conductivity technology: an alternating current at constant voltage is set up between a pair of graphite primary electrodes. The secondary electrodes, made from platinum, adjust the drive potential at the primary electrodes to compensate for any fouling. The voltage measured between the primary electrodes varies depending on the resistance of the medium, and thus the conductivity.

Measurements	
Measurement principle	4-electrode type conductivity sensor (2 graphite + 2 platinum).
Conductivity measurement range	0 - 200.0 μ S/cm 0 - 2,000 μ S/cm 0.00 - 20.00 mS/cm 0.0 - 200.0 mS/cm
Resolution	from 0.01 to 1, depending on the range
Accuracy	+/- 1 % of full scale
Salinity measurement range	5-60 g/kg
TDS-KCl range	0 – 133,000 ppm
Response time	< 5 s
Operating temperature	0 °C to 50 °C
Temperature compensation	Via an NTC thermistor
Storage temperature	- 10 °C to + 60 °C
Signal interface	Modbus RS-485 as standard and SDI-12 as an option
Measurement refresh rate	< 1 second maximum
Power supply for sensor	5 to 12 volts
Power consumption	Standby: 25 μ A When sending via RS-485 (1 measurement/second): 6.3 mA When sending via SDI-12 (1 measurement/second): 9.2 mA Current pulse: 500 mA
Sensor	
Dimensions	Diameter: 27 mm; Length not including cable: 177 mm (not including temperature sensor)
Weight	350 g (sensor + 3 m of cable)
Materials in contact with the medium	PVC, POM-C, stainless steel
Maximum pressure	5 bar
Cable/connection hardware	9-wire shielded conductor, uncoated-strand polyurethane sleeve
Ingress protection rating	IP68

2.2.6 CTZN sensor: inductive conductivity.

The operation of the CTZN sensor is based on a conductive induction measurement principle.

A ring-type coil is excited at a fixed frequency and the response is retrieved on a second coil, linked to the excited coil. The coupling between the coils varies depending on the conductivity of the conducting solution present.

Measurements				
Measurement principle	Inductive conductivity sensor with temperature compensation			
Conductivity measurement range	0.0 to 100.0 mS/cm			
Resolution	0.1			
Salinity measurement range	5-60 g/kg			
Operating temperature	0 to 50 °C			
Temperature compensation	Via an NTC thermistor or an external measurement			
Measurement accuracy of T°C	± 0.1 °C over a range of 0-40 °C			
Response time	T90<30 s			
Storage temperature	-10 °C to 60 °C			
Signal interface	Modbus RS-485 and SDI-12			
Measurement refresh rate	< 1 second maximum			
Power supply for sensor	5 to 28 volts, max. voltage: 30 V			
Power consumption	Automatic standby of < 50 µA, warm-up time: 100 ms When sending via Modbus RS-485/ Range 0-100 mS/cm			
		Vin 5V	Vin 12 V	Vin 24 V
	1 measurement/s	31 mA	15.5 mA	11.5 mA
	Max. current peak of 700 mA for 2 mS, 350 mA for 150 mS			
Sensor				
Dimensions	Max. diameter: 62.4 mm, Length: 196 mm			
Weight	700 g			
Materials in contact with the medium	EPDM, PVC, stainless steel			
Maximum pressure when immersed	5 bar			
Cable/connection hardware	9-wire shielded conductor, uncoated-strand polyurethane sleeve			
Ingress protection rating	IP68			

2.2.7 VB5 sensor: Sludge Blanket detection.

The principle of measure is based on the mitigation of the Infra-Red signal in 870 nm through an optical path of 5mm. The sensor delivers measures in Sludge Blanket detection in % of transmission IR. For a better precision, the optics of the sensor are regulated in temperature.

Measurements	
Measurement principle	Optical IR (870 nm) based on IR absorption
Range of measure	Sludge blanket : 0-100 %
Resolution	Sludge blanket : 0.01 à 0.1 %
Accuracy	Sludge blanket : +/- 2%
Response time	< 35 secondes
Temperature measure	
Principle of measure	NTC
Working temperature	-5.00 °C to + 60,00°C
Resolution	0,01 °C
Accuracy	+/- 0.5 °C
Storage Temperature	-10°C to + 60°C
Degree of protection	IP 68
Singal Interface	Modbus RS-485 or SDI-12
Refreshment of the measure	Maximum < 1 seconde
Power supply	5 to 28 volts
Consumption	Standby : 25 µA (5 V) Average RS485 (1 mesure/seconde) : 4.5 mA (5V) Average SDI12 (1 mesure/seconde) : 4.5 mA (5V) Curent Pulse : 100 mA during 30 mS Heating times : 100 mS
Sensor	
Weight	750 g (sensor)
Material	DELFIN, Nickel-plated brass, EPDM
Pressure max.	5 bars
Cable/ connexions	9-wire shielded conductor, uncoated-strand polyurethane sleeve
Ingress protection rating	IP68

2.2.8 MES5 sensor: Sludge Blanket detection, Suspended Solid, Turbidity.

The principle of measure is based on the mitigation of the Infra-Red signal in 870 nm through an optical path of 5mm. The sensor delivers measures in Suspended Solid (g/l), Turbidity (FAU) and Sludge Blanket detection in % of transmission IR. For a better precision, the optics of the sensor are regulated in temperature.

For a measure of Suspended Solid, the sensor is directly calibrated on the material to be measured (sample of sludge).

In Turbidimeter version the sensor delivers measures on a range 0-4000 FAU (Formazine Attenuation Unit) and is calibrated with solutions of Formazine.

Temperature: measures and regulation of optics via CTN.

Suspended Solid measure	
Principle of measure	Optical IR (870 nm) based on IR absorption
Range of measure	SS : 0-50 g/L Turbidity : 0-4000 FAU Sludge blanket : 0-100 %
Resolution	SS : 0.01 g/L Turbidity : 0.01 à 1 FAU Sludge blanket : 0.01 à 0.1 %
Accuracy	SS < 10 % Turbidity : +/- 5% (range 200-4000 FAU) Sludge blanket : +/- 2%
Response time	< 35 secondes
Temperature measure	
Principle of measure	NTC
Working temperature	-5.00 °C to + 60,00°C
Resolution	0,01 °C
Accuracy	+/- 0.5 °C
Storage Temperature	-10°C to + 60°C
Degree of protection	IP 68
Singal Interface	Modbus RS-485 or SDI-12
Refreshment of the measure	Maximum < 1 seconde
Power supply	5 to 28 volts
Consumption	Standby : 25 µA (5 V) Average RS485 (1 measure/seconde) : 4.5 mA (5V) Average SDI12 (1 measure/seconde) : 4.5 mA (5V) Curent Pulse : 100 mA during 30 mS Heating times : 100 mS
Sensor	
Weight	750 g (sensor)
Material	DELTRIN, Nickel-plated brass, EPDM
Pressure max.	5 bars
Cable/ connexions	9-wire shielded conductor, uncoated-strand polyurethane sleeve
Ingress protection rating	IP68

2.2.9 StacSense Sensor : parameter SAC254 and equivalent values of CODEq, BODEq, TOCe_q and Turbidity eq.

The measuring principle of this sensor is based on the attenuation of the UV signal, centered on 254 nm, through an optical slot of 2 or 50mm (two models available). The sensor delivers observed fluid temperature measurements, SAC254 spectral attenuation coefficient (unit: 1/m), CODEq, BODEq and TOCe_q equivalents in mg/l. Finally, the equivalent unit in turbidity is FAU (Formazine Attenuation Unit). The sensor also incorporates internal temperature measurements to optimize optical measurement.

For the main parameter SAC254 and the turbidity equivalence, the sensor is directly calibrated in clear water in two steps, by successive activation of the two optical sources, UV and green radiation.

Measurements	
Measurement principle	UV optics (254 nm) based on absorptiometry Turbidity compensation by optical measurement at 530 nm (green)
Measuring range	<u>Optical path 2 mm :</u> SAC254 : 0-750 1/m CODEq: 0-1300 mg/L BODEq : 0-350 mg/L TOCe _q : 0-500 mg/L Turbidity eq : 0-500 FAU <u>Optical path 50 mm :</u> SAC254 : 0-30 1/m CODEq : 0-50 mg/L BODEq : 0-15 mg/L TOCe _q : 0-20 mg/L Turbidity eq : 0-40 FAU
Resolution	SAC254: 0.01 1/m Turbidity eq : 0.01 to 1 FAU
Accuracy	SAC254: +/- 3% Turbidity eq: +/- 7%
Response time (T90)	Optical measure : < 5s Temperature : < 3mn
Temperature measurement	
Measuring principle T°C	NTC
Operating temperature	0.0 °C to + 40, 0°C
Resolution	0,01 °C
Accuracy	+/- 0.5 °C
Storage temperature	-10°C to + 50°C
Index of protection	IP 68
Signal interface	Modbus RTU (RS-485) / SDI-12 (TTL)
Speed of measurement refresh	Max : 1 measure / 2s
Sensor Power Supply	5.4 to 26 VDC
Consumption	Data for 12VDC voltage: Standby: <10 µA Maximum current peak: 400mA (1.5ms) Average current (1 measure/2s): 30 mA Energy for 1 measure (1.5s): 300µWh
Sensor	
Weight	1600 – 1800 g depending on optical path (cable not included)
Materials in contact with the environment	Body: 316 stainless steel (1.4401)
Maximum pressure	Optical windows: Quartz (Corning 7980)
Cable/ connections	Cable: Bare Thread Polyurethane Sheath

Ingress Protection rating	IP68
Max. immersion depth	50 meters
Maximum pressure	5 bars
Operating temperature	0-40°C
Storage temperature	-10°C to +50°C
PH range	pH2 to...pH12
Dimensions (D x L) (mm)	48x371 or 48x419 (see overall dimensions diagram)
Weight	1600 - 1800g depending on the optical path (cable not included)
Equipment	Body: Stainless steel 316 (1.4401) Optical windows: Quartz (Corning 7980) Cable: Bare wire with polyurethane sheath Seals: Fluoroelastomer (FPM/FKM)
Cable	9 shielded conductors in 3, 7 and 15m. <i>Other lengths on request</i>

3. Installation

3.1 Description and mounting of the controller.

3.1.1 Description of the front face.

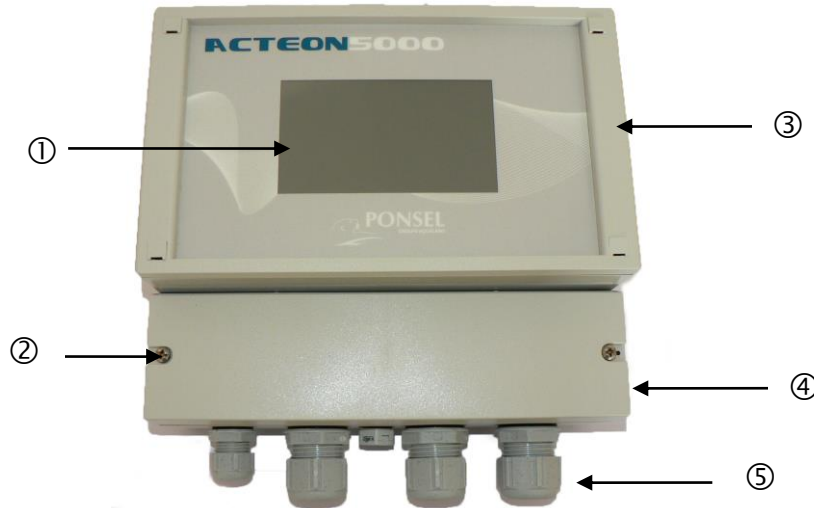

1	Touch screen
2	Screws securing lower cover (2 screws)
3	Upper cover – do not open.
4	Lower cover - remove to make electrical connections
5	Four cable glands

3.1.2 Equipment required.

The ACTEON 5000 unit is shipped with a bag containing 2 mounting brackets (with 2 pan head screws) and a set of 12 connectors (two 5-contact connectors, three 4-contact connectors, three 3-contact connectors, three 2-contact connectors and one 1-contact connector to connect up the power supply).

Equipment required for installing the unit and for making the electrical connections:

- PH1x75 mm cross head screwdriver for attaching the unit's mounting brackets and for the screws securing the cover which protects the electrical connections,
- 2.0 x 75 mm flat-blade screwdriver for working on the various electrical connection terminals.

To mount the ACTEON 5000 on a wall, use M5 screws (with a head size of < 10.8).

3.1.3 Outline drawings of the ACTEON 5000.

➤ Overall dimensions of the ACTEON 5000.

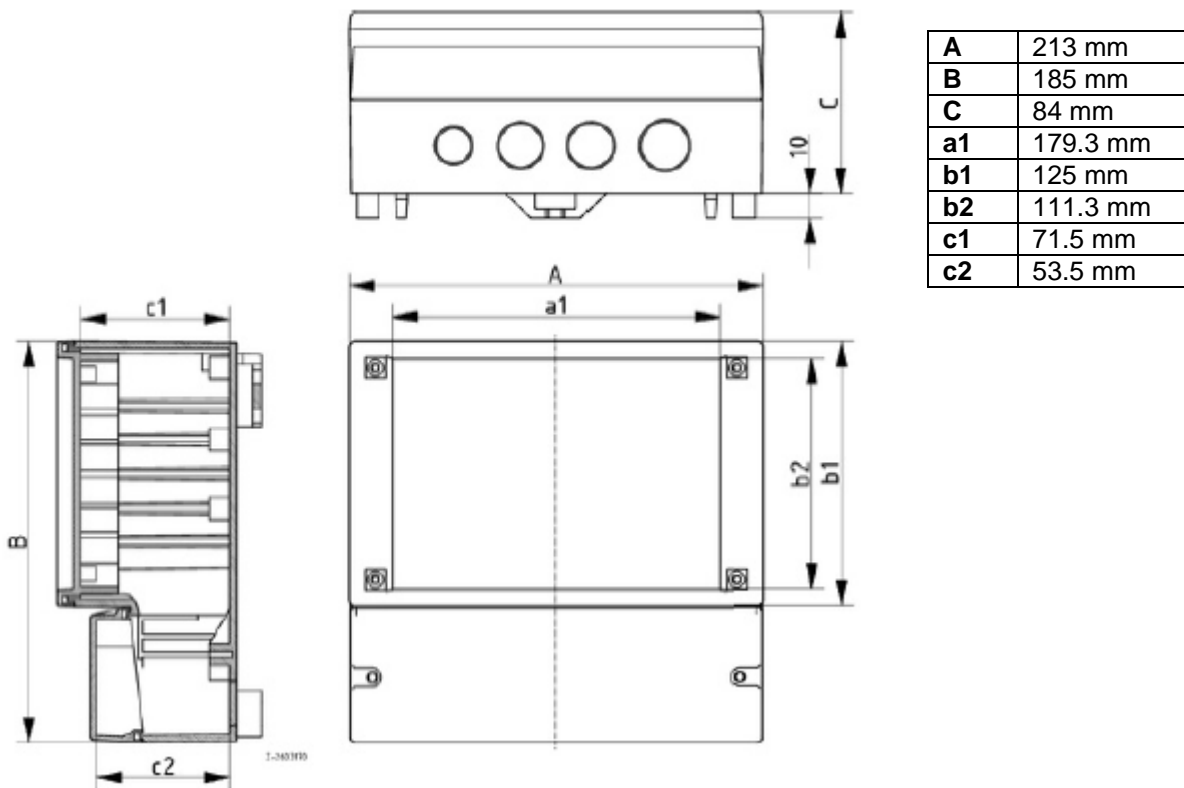

Diagram 1: Outline drawing for the ACTEON 5000 unit

➤ Dimensions when mounted on a wall.

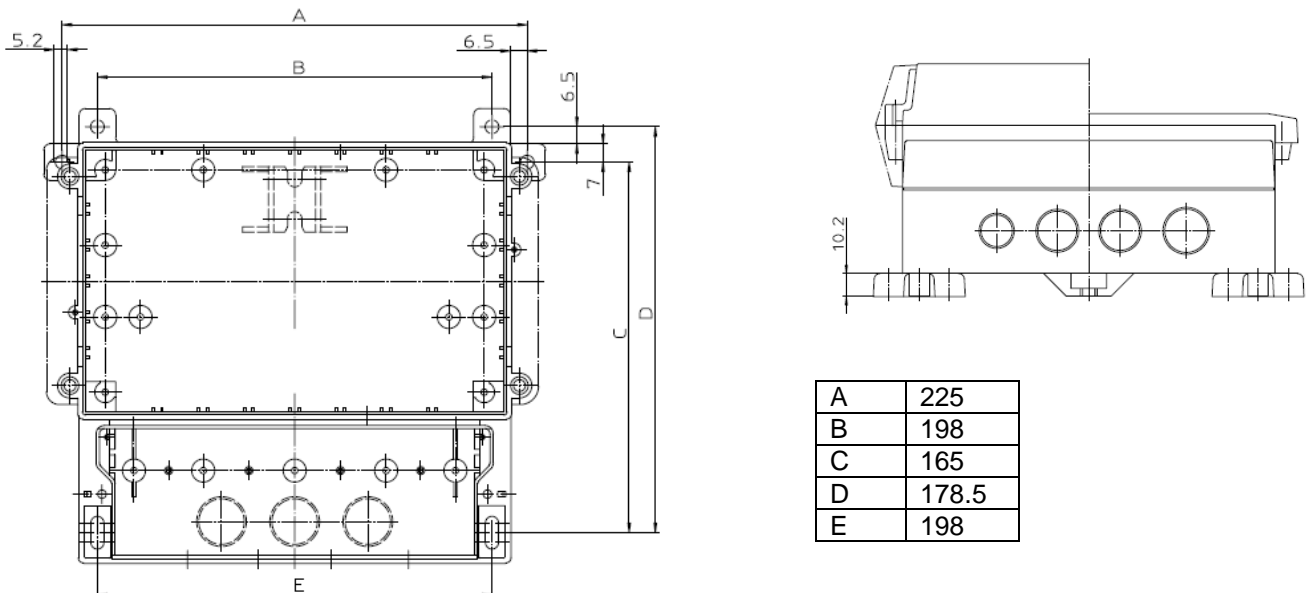







Diagram 2: Outline drawing for the ACTEON 5000 unit – wall mounting

3.2 Electrical connections.

3.2.1 Safety instructions – Installation.

Isolate the power supply to the measuring device before performing any electrical connection work.

	The electrical wiring and cabling work must be performed exclusively by authorized personnel.
	Due to the risk of electrocution, systematically isolate the power supply to the controller before performing electrical connection work.
<i>Warning for the model supplied with 10 – 30V</i>	
	Risk of electrocution: do not connect a device operating in mains power mode to a model supplied with 10-30 V.
	Risk of electrocution: the connection of a protective earth (PE) is compulsory when wiring and cabling both 100-240 Va.c. and 10-30 Vd.c. models.
<i>Warning for wiring the relays</i>	
	Fire risk. Since the relay contacts have a nominal value of 6 A, the external loads connected to the relays must be fitted with devices which limit the current to < 6 A.

Open the unit's lower cover to access the controller's wiring terminals.

Unscrew the two screws which hold the lower protective cover.

Before removing the cover, loosen all the cable glands so that the cables can slide in and out.

Figure 3 shows the transmitter's wire connection zone when the lower protective cover is removed.

3.2.2 Description of the wiring.

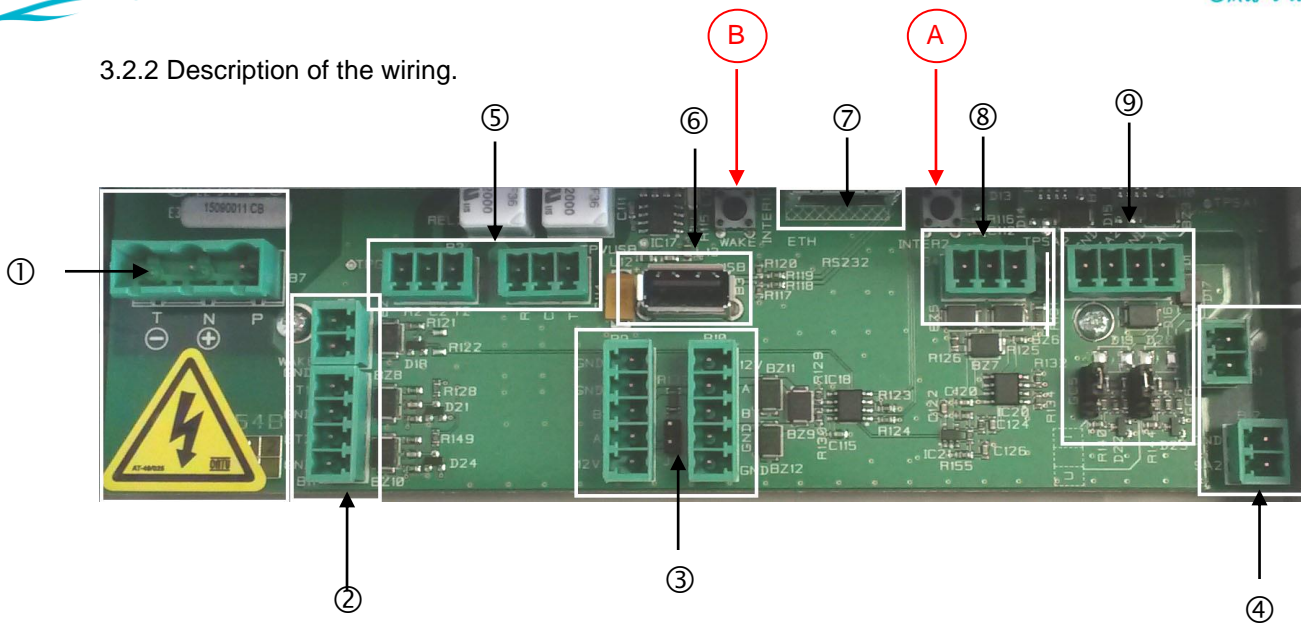

Diagram 3: Photograph showing the terminals on the circuit card

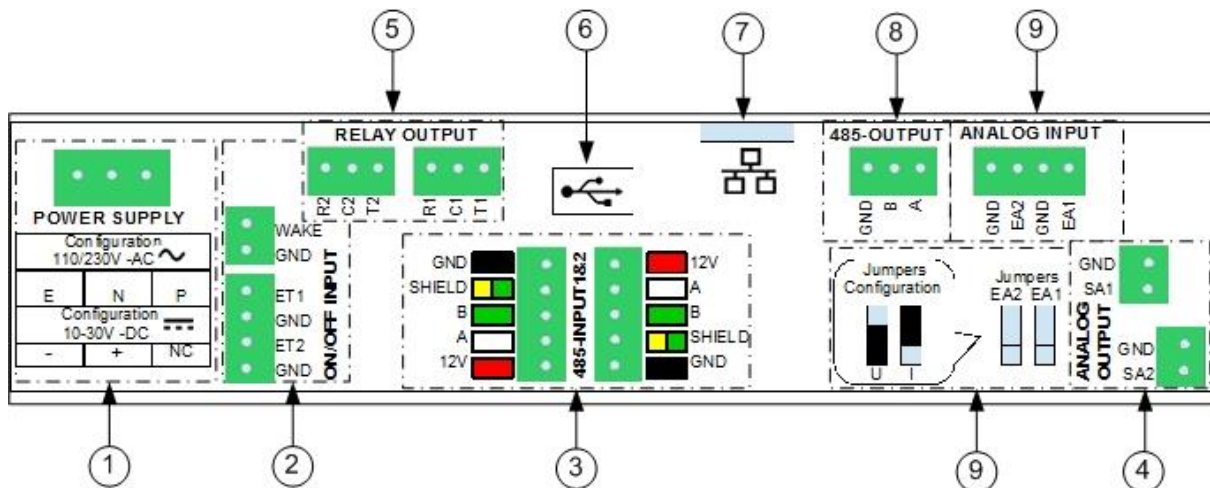

Diagram 4: Diagram of the terminals affixed (as a self-adhesive label) to the protective cover

Identification	Description	Terminal identification on circuit card	Terminal identification on protective cover (self-adhesive label)
1 – Power Supply Option	110-230 V a.c. power supply Yellow and green - Earth Blue - Neutral Brown - Phase 10-30 V d.c. power supply Black Red	T (-) N (+) P T (-) N (+) P	E N P - + NC
2 – ON/OFF INPUT	<i>Two dry contract inputs</i>	WAKE – Inactive GND – Inactive ET1 GND ET2 GND	WAKE – Inactive GND – Inactive ET1 GND ET2 GND
3 – Digital sensors RS485 - INPUT	<i>Two digital sensor inputs</i> V- sensor power supply: Black Shielding – Yellow and Green RS485 - Green	GND GND B	GND SHIELD B

	RS485 - White V+ sensor power supply: Red	A 12V	A 12V
4 – ANALOG OUTPUT	<i>Two analog outputs</i> 0-20 mA or 20-0 mA or 4-20 mA or 20-4 mA Output 1: - Output 1: + Output 2: - Output 2: +	GND SA1 GND SA2	GND SA1 GND SA2
5 – RELAY OUTPUT	2 relay outputs Output 1: Release (default is NC) Output 1: Switch Output 1: Operate (default is NO) Output 2: NC Output 2: Switch Output 2: NO	R1 C1 T1 R2 C2 T2	R1 C1 T1 R2 C2 T2
6 – USB	USB port For downloading data	USB	
7 – Ethernet	Ethernet option	ETH	
8 – 485 OUTPUT	<i>One RS485 output</i> RS485 (-) RS485 (+)	G B A	GND B A
9 - ANALOG INPUT	<i>Two analog inputs</i> Analog input 2 Input 2: - Input 2: + Analog input 1 Input 1: - Input 1: + Jumpers: Selection jumpers <i>Voltage or Current</i>	GND EA2 GND EA1 U I	GND EA2 GND EA1 U I
A - RESET	RESET button	RESET	/
B- WAKE	A button which should not be activated	WAKE	/

Table 1: Description of the electrical connections

➤ **Electrical connections for digital sensors:**

Diagram 5 below shows the electrical connections required for digital sensors when the cable lengths are 15 meters or less, and when the cable lengths are more than 15 meters. When a CTZN sensor is connected, the wiring diagram to be used is that corresponding to a cable length of more than 15 meters, regardless of the length of the cable.

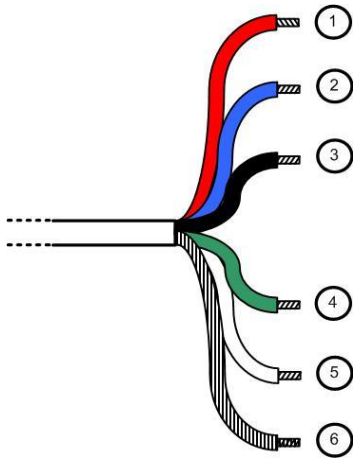

1 - red	V+ power
2 - blue	SDI-12 – Not connected
3 - black	GND
4 - green	B " RS-485 "
5 - white	A " RS-485 "
6 - green/yellow	Cable shield

Connect cable 3 and 6

RED YELLOW ORANGE VIOLET PINK	V+ power
2- blue	SDI-12 – Not connected
3 - black	V- power
4 - green	B " RS-485 "
5 - white	A " RS-485 "
6 – green/yellow	Cable shield

Cable length more than 15 meters
Connect cable 3 and 6

Diagram 5: Sensor connection for a cable length of 15 meters or less, and of more than 15 meters.

4. User Interface

4.1 Home screen.

The figure below shows the data displayed on the home screen when two sensors are connected to the ACTEON 5000. In this specific case, a pH/Temperature combined sensor and an oxygen sensor are connected to the ACTEON 5000.

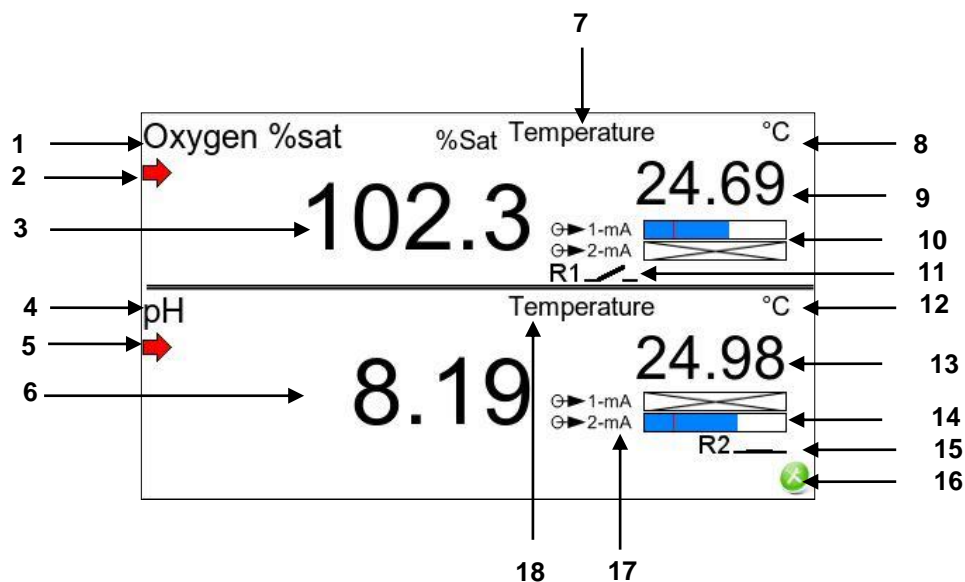

1	Primary parameter measured by sensor 1	10	State of the two analog outputs: in this example, analog output 1 is assigned to sensor No.1. The red mark indicates 4 mA.
2	Stability indicator for the primary parameter measured by sensor 1	11	State of Relay 1. In this example, relay 1 is assigned to sensor 1 and is in an open position.
3	Real-time value of the primary parameter measured by sensor 1	12	Unit for the secondary parameter measured by sensor 2
4	Primary parameter measured by sensor 2	13	Real-time value of the secondary parameter measured by sensor 2
5	Stability indicator for the primary parameter measured by sensor 2	14	State of the two analog outputs: in this example, analog output 1 is assigned to sensor No.2. The red mark indicates 4 mA.
6	Real-time value of the primary parameter measured by sensor 2	15	State of Relay 2. In this example, relay 2 is assigned to sensor 2 and is in an open position.
7	Secondary parameter measured by sensor 1	16	Navigation icon used to access the main menu
8	Unit for the secondary parameter measured by sensor 1	17	Logos representing the analog outputs
9	Real-time value of the secondary parameter measured by sensor 1	18	Secondary parameter measured by sensor 2

Table 2: description of the home screen.

If only one sensor is connected to the ACTEON 5000 then lines are displayed in the lower part of the display where the parameter information and units would normally appear.

4.2 Navigation icons.

The device has a touch screen so that the user can navigate through the various menus using the icons listed in the table below.













Icon	Functionality
	Moves downwards through the options.
	Moves upwards through the options.
	Takes you back to the previous screen.
	Opens the Main Menu containing all the main programming functions for the device. This icon appears on the home screen.
	Takes you back to the home screen.
	Cancels an action and takes you back to the previous screen.
	Confirms a selection and opens a new screen.
	Confirms a programming task or action.
	Opens the menu used to modify the Modbus address for the digital sensors.
	Indicates an unusual situation, and provides information which can be consulted. When it appears on the home screen, it indicates that the sensor is currently in a special state which may be consulted by pressing on the value displayed.
	Transfers data to a USB stick.
	Indicates that the screen is locked.

Table 3: Functionalities of the navigation icons.

5. Setting up

5.1 Initial start-up.

When the transmitter is switched on, the home screen (i.e. the main measurement screen) appears with no indication of the sensor(s) installed if no sensors have yet been configured.

If the sensors connected have already been configured, measured values may be displayed (primary and secondary parameters).

As an initial step, the operator can set the display language, the date format and the date and time.

➤ *Setting the language:*

To access the language menu, follow the sequence shown below from the home screen:



At the home screen, select the Main menu icon, then the Device settings icon, and finally the Language icon.

➤ *Setting the date and time:*

From the Device settings menu, select the Date/hour settings icon.



Option	Description
Format	Used to set the date format: the options are DD/MM/YY, YY/MM/DD and MM/DD/YY. Place the pointer on the "Format" line using the up and down navigation icons, then select the Confirm icon.
Date	Select the "Date" line, press the confirm icon and then set the date by changing the values on the screen which, in order, correspond to the day, month and year. Use the up and down navigation icons to change the numbers and the Confirm icon to move from one variable to another.
Hour	Used to set the time: select the "Hour" line using the up and down navigation icons, press the Confirm icon, then set the hour and minutes.
Summer/winter time	To activate/deactivate automatic change-over to summer or winter time, select the "Summer/Winter time" line, confirm with the Confirm icon and select "Yes" or "No".

5.2 Installation of digital sensors.

When sensors are connected to the transmitter for the first time they must be installed by running a SCAN (to scan the addresses from 1 to 243).

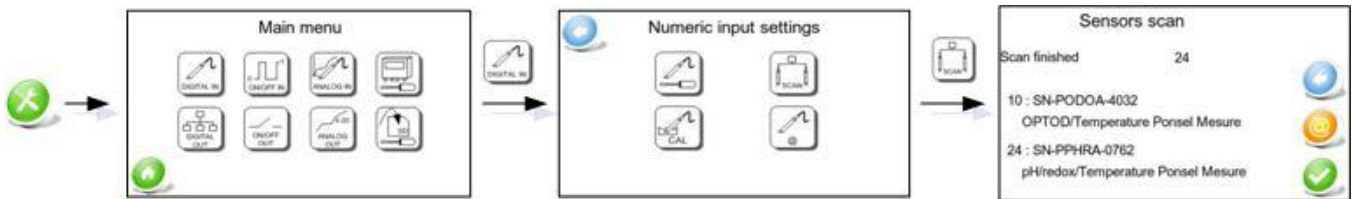

As soon as the transmitter detects a sensor, it displays its address, its serial number (which is also engraved on the body of the sensor) and a description of the sensor.

In the example above, pH and oxygen sensors have been detected: the pH sensor is at address 24, the sensor's serial number is SN-PPHRA-0762 and the description of the sensor is pH/redox/Temperature Ponsel Mesure. The OPTOD sensor is at address 10, the serial number is SN-PODOA-4032 and its description is OPTOD/Temperature Ponsel Mesure.

The operator can stop the SCAN operation at any time by pressing on the  icon.

If no sensor is detected, or 2 sensors have the same address (an address conflict) or a communication error is detected, then the device displays a warning message accompanied by the  icon.

Pressing on the  icon accesses the addressing menu (refer to section 6.2.1 for more details about the addressing function) where the operator can change the sensor's address in the event of an address conflict (i.e. if 2 sensors have the same address).

5.3 Selection of the parameters.

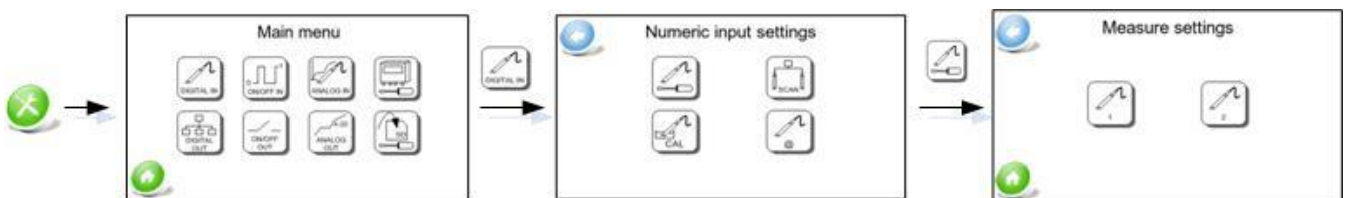

Once ACTEON has detected the sensors, the parameters measured by the sensors must be set up. For each sensor, a primary and a secondary parameter can be selected.

To access the measurement settings menu, follow the sequence shown below from the home screen:

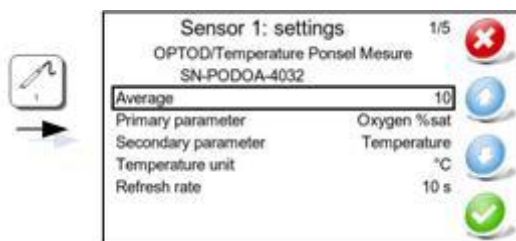

To set up the primary and secondary parameters for sensor 1, select the corresponding icon.



To select a different line, press on the  and  icons.

Open the set-up line of interest using the Confirm icon, .

Set-up line	Functionality
Average	Used to set the number of measurements (from 1 to 50) from which the moving average is calculated.
Primary parameter	This line lets the operator select the primary parameter for sensor 1, which shall then be displayed in the upper part of the home screen (refer to item 3 in Table 2). The next window then lets the operator select from a list of the parameters measured by sensor No. 1 (up to 4 parameters).
Secondary parameter	This parameter shall be displayed in the upper right-hand corner of the upper part of the home screen (refer to item 7 in Table 2). The next window then lets the operator select from a list of the parameters measured by sensor No. 1.
Measurement range	The measurement range can only be set for the conductivity and turbidity parameters, as indicated in the table below.
Temperature units	This line is used to select the units in which the temperature parameter will be displayed (°C or °F).
Refresh rate	This line lets the operator select an interval between each measurement of between 1 and 60 seconds.

The sensors can measure up to 4 parameters, as described below:

Sensor	Parameters measured	Measurement range options
OPTOD	Temperature Oxygen as a % of saturation Oxygen in mg/L Oxygen in ppm	
PHEHT	Temperature pH Redox in mV	
EHAN	Temperature Redox in mV	
C4E	Temperature Conductivity in $\mu\text{S}/\text{cm}$ or mS/cm Salinity in g/kg TDS in ppm	Conductivity: Auto (Automatic range) 0-200 $\mu\text{S}/\text{cm}$ 0-2,000 $\mu\text{S}/\text{cm}$ 0-20 mS/cm 0-200 mS/cm
NTU	Temperature Turbidity in NTU Turbidity in FNU Turbidity in mg/L	Turbidity: Auto (Automatic range) 0-50 NTU 0-200 NTU 0-1,000 NTU 0-4,000 NTU
CTZN	Temperature Conductivity in mS/cm (default parameter) Salinity in g/kg Conductivity (not compensated for temperature) in mS/cm	
VB5	Temperature Sludge Blanket detection	
MES	Temperature Sludge Blanket detection Suspended Solid Turbidity	
Stacsense	Temperature	









SAC254
CODeq
BODeq
TOCeq
Abs.UV
Abs.green
Turbidity
Transm.UV
Transm.green

6. Programming

6.1 Main menu.

From the home screen, access the main menu using the  icon.





Icon	Functionality
	This menu is dedicated to PONSEL digital sensors and is used to set up the 2 digital inputs, including: the sensor detection function (SCAN), the setting-up of the parameters measured by the sensors, the calibration of the sensors and the setting of each sensor's Modbus address.
	This menu is used to set up the two On/Off inputs for the washing, Event, Alert, etc. functions.
	This menu is used to select voltage or current for the analog inputs.
	This menu is dedicated to configuring the ACTEON 5000 and is used to: set-up the screen; consult the hardware/software version and the events log; set the date/time and language; return to factory settings and set a password.
	This menu is used to set up the optional Ethernet digital output and the MODBUS functionality.
	This menu is used to set up the two relay outputs in alarm/fault mode or based on thresholds.
	This menu is used to set up the two analog outputs for the 0/4-2 mA or PID linking functions.
	This menu is used to set up the recording/exporting to a USB stick function.



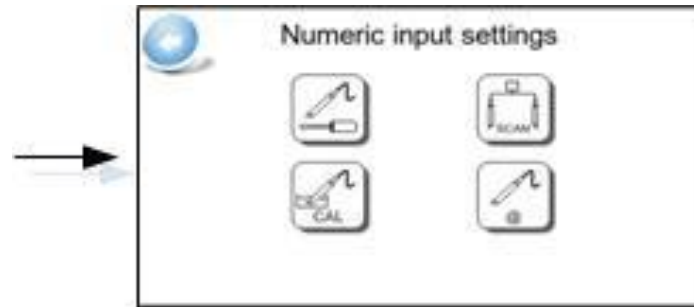

6.2 Description of the menus.

6.2.1 Configuring the digital inputs.

This menu is used to set up two digital inputs when installing PONSEL sensors and is also used to: select the parameters measured by the sensors; scan the network of sensors connected to the ACTEON 5000; calibrate the sensors; and modify the Modbus address of the sensors.



To access the "Numeric input settings" window from the Main menu, select the  icon.

Icon	Functionality
	Used to access the setting up of digital sensors (parameter selection, etc.).
	This menu lets you scan and detect the PONSEL digital sensors connected to the ACTEON 5000.
	This icon lets the user calibrate the digital sensors and set up the compensation parameters.
	This menu lets the operator modify the Modbus address of a sensor (notably used when two identical sensors are installed on the device).

➤ **Setting up digital sensors**

The menu used to set up the digital sensors is used to: select the parameters which will be displayed on the home screen; select the number of values from which the average is calculated (moving average); select the units (if necessary); and set up the interval between each measurement.

Section 5.3 provides a detailed description of this functionality.

➤ **Scan of the sensors connected to the transmitter.**

The SCAN functionality detects and identifies the sensors connected to the ACTEON 5000. This task is only performed when the device is switched on and when a sensor in the measurement chain is changed.

Refer to section 5.2 for more details about the SCAN function.

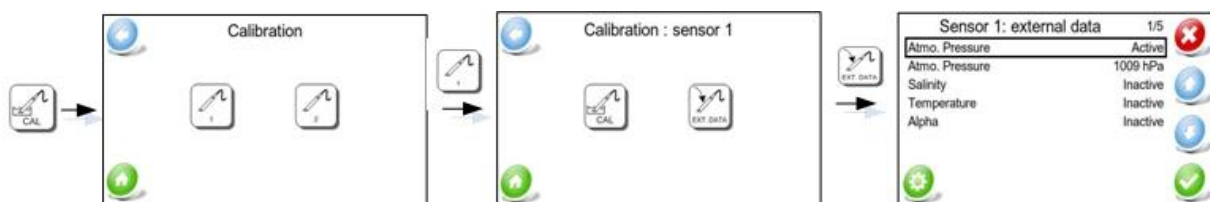

➤ **Calibration of digital sensors.**







From the "Numeric input settings" window, select the  icon then select the sensor to be calibrated.

This window is used to calibrate the parameters measured by the selected sensor, or to set the external compensation data.

Icon	Functionality
	Used to access the sensor's calibration menu
	This menu is used to set up the external data used for compensation purposes

The **external compensation data** is detailed in the table below:



Set-up line	Functionality
Atmo. pressure	Atmospheric pressure compensation is applied to the OPTOD sensor (measurement of oxygen levels using optical technology). The atmospheric pressure sensor is built into the ACTEON 5000. The first line is used to activate the compensation and to access a second line which is used to adjust this parameter (possible values: 0 to 2,000 hPa).
Salinity	Salinity compensation can be applied to the Oxygen in mg/L parameter measured by the OPTOD oxygen sensor. The first line is used to activate the compensation and to access a second line which is used to adjust this parameter (possible values: 0 to 85.00 g/kg).
Temperature	Each sensor is equipped with its own temperature sensor, and the temperature recorded is considered if temperature compensation is required (for the pH, oxygen in mg/L and conductivity parameters). However, it is also possible to enter a fixed external compensation value. The first line is used to activate the compensation and to access a second line which is used to adjust this parameter (possible values: 0.00 to 40.00 °C).
Alpha	This coefficient can be set for the Non-compensated conductivity parameter measured by the CTZN sensor (possible values: 0.0 to 6.0 %/°C) in order to activate linear compensation.

To select the line above or below, or to increase or reduce a value, use the  and  icons.

The  icon confirms the value set for the external compensation data. Any changes made become effective when the "Communication completed successfully" message appears.

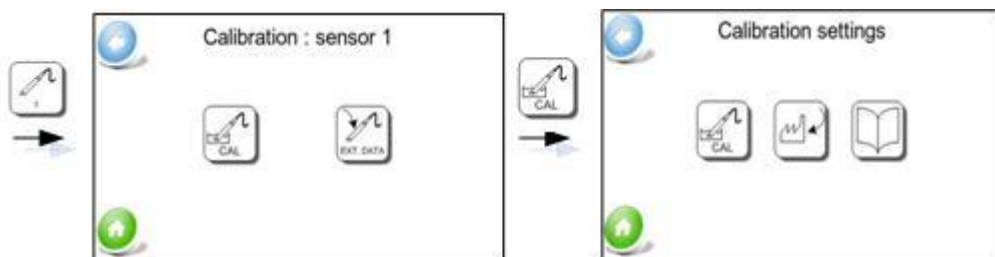
To access the "Calibration settings" menu from the "Calibration: sensor 1 (or 2)" window, select the "Calibration" icon.



Icon	Functionality
	Used to access the sensor's calibration menu.
	This menu is used to apply the default calibration coefficients set in the factory.
	Detailed calibration log: this menu contains the data for the last ten calibrations (offset/gain) ... The coefficients for a specific calibration can be reused.

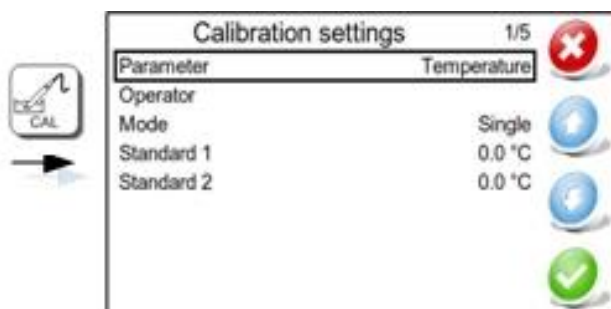

The **Calibration settings** window lets the operator: select the parameter to be calibrated; enter the operator's name; select a calibration mode and set the values of the standards used.

Set-up line	Functionality
Parameter	The parameter to be calibrated can be selected from a drop-down menu which offers the parameters measured by the sensor.
Operator	This menu is used to enter the Operator's name (maximum of 13 characters) which will be saved with the results of a calibration process.
Type	This line appears if the parameter selected for calibration is <u>oxygen as a %Sat</u> . To complete this line, the operator can select either a 2-point calibration (OFFSET and GAIN) or a single-point calibration (GAIN only).
Mode	The options are: "Single" or "Multiple" mode: when several sensors of the same type are connected, a parameter common to all the sensors can be calibrated. The "Single" option is used when calibrating one parameter for one sensor, and "Multiple" is used when calibrating one parameter for 2 sensors (e.g. the Temperature parameter measured by all the sensors, or the connection of 2 pH sensors).
Standard 1	In the "Standard 1" window, which only appears if the value can be modified, the value of the Standard can be set using a number pad and will be used during the first step of the calibration for the calculation of the OFFSET. The value which can be set cannot exceed the minimum and maximum values.

Standard 2 In the "Standard 2" window, which only appears if the value can be modified, the value of the Standard can be set using a number pad and will be used during the second step of the calibration for the calculation of the GAIN.
The value which can be set cannot exceed the minimum and maximum values.



Site If a NTU sensor or a MES sensor is connected to the device and when selecting a calibration in mg/L or in g/L, the calibration process will be saved in a file saved under the name of the site. Up to 10 sites can be configured, each identified using 8 characters.

Pressing on the  icon validates the setting of the calibration data and starts the first calibration step ("Standard 1" window).

In the window corresponding to the first step in the calibration, the first line indicates the value of the N1 standard and the second line presents the measurement delivered by the sensor in contact with the standard solution.

A message indicates if the value measured by the sensor is stable or not. The confirmation of the first calibration step (gearwheel icon) initiates the second step ("Standard 2" window).

Once the second calibration step has been confirmed, a summary window appears which presents the information about the values of the standards used and the coefficients calculated.



The appearance of the  icon on a coefficient calculation line indicates that the coefficient has been confirmed, whereas the  icon indicates that the coefficient obtained is out-of-range.

The table below presents the calibration steps for each parameter:

PARAMETER	STANDARD 1	STANDARD 2
Temperature °C	Water at a temperature close to 0 °C (bath of crushed ice, with T°C measured using a certified thermometer)	Bath of crushed ice, with T°C measured using a certified thermometer
O2 % Sat	0.00 % (water + sulfite (2% sulfite solution))	100.0 % (Humid, oxygen-saturated air)
pH	7.01 (buffer solution at 25 °C) Enter the corresponding pH value at the temperature of the standard solution.	4.01 (or 9.01; 10.01 buffer solution at 25 °C) Enter the corresponding pH value at the temperature of the standard solution.
Redox	0 mV (sensor exposed to air for an electronic 0)	240 mV (or 470 mV buffer solution)
Conductivity - C4E sensor Range 0.0-200.0 µS/cm Range 0-2,000 µS/cm Range 0.00-20.00 mS/cm Range 0.0-200.0 mS/cm	0 µS/cm Sensor exposed to air	Enter the value of the solution at 25 °C. 84 µS/cm (buffer solution at 25 °C) 1,413 µS/cm (buffer solution at 25 °C) 12,880 µS/cm (buffer solution at 25 °C) 111.8 mS/cm (buffer solution at 25 °C)
Conductivity – CTZ sensor Range 0.00 - 100.0 mS/cm	Deionised water at 0.00 mS/cm	Select the second point based on the range selected: 1.413 mS/cm (buffer solution at 25 °C) 2 mS/cm (buffer solution at 25 °C) 12.88 mS/cm (buffer solution at 25 °C) 56.84 mS/cm (buffer solution at 25 °C)
Turbidity Range 0.00-50.00 NTU Range 0.0-200.0 NTU Range 0-1,000 NTU Range 0 - 4,000 NTU Range 0-4000 FAU	0 NTU Distilled water	25.00 NTU (from a 4,000 NTU stock solution) 100.0 NTU (from a 4,000 NTU stock solution) 500.0 NTU (from a 4,000 NTU stock solution) 2,000 NTU (from a 4,000 NTU stock solution) 2,000 NTU (from a 4,000 NTU stock solution)

Sludge blanket detection	100 % in tap water	/
SAC254 Turbidity eq	Clear water (active UV source)	Clear water (530nm (green) active source)

➤ **Addressing of the digital sensors.**

To access the "Addressing" menu, select the  icon in the Sensors scan window or select the  icon in the Numeric input settings screen.

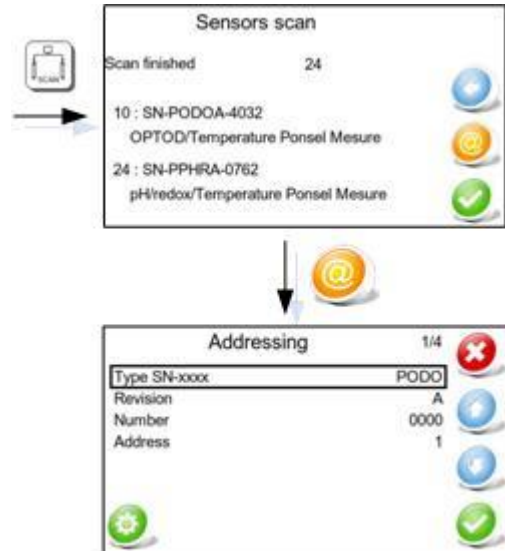

The first 3 lines of the "Addressing" window are used to define the serial number of the sensor affected by the change of address.

After configuring the Serial No. and address, confirm with the  icon.

The sensor's serial number is engraved on the body of the sensor and comprises the following information:

Set-up line	Functionality
Type SN-XXXX	PODO for an OPTOD sensor PNEP for a Turbidity sensor PC4E for a C4E sensor PPHR for a PHEHT sensor PORP for an ORP sensor PTUR for a VB5 – MES 5 sensor PUVT for a Stacsense
Revision	Represented by a letter (A in the example above)
Number	A 4 or 5-digit number (0000 in the example above)
Address	Between 1 and 243

After configuring the Serial No. and address, confirm with the  icon. The change made to the Modbus address becomes effective when the "Communication completed successfully" message appears.

6.2.2 Configuring the On/Off inputs.

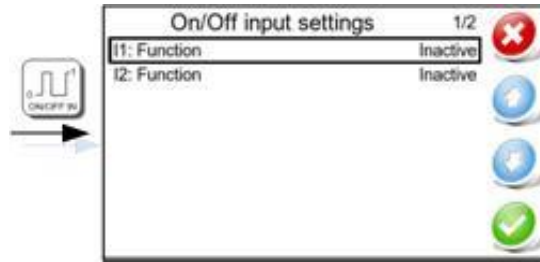

Set-up line	Functionality
I1: Function	<p>Programming of On/Off Input No.1: <i>Inactive</i> (no programmed action)</p> <p><i>Washing</i>: used with an external washing system, for which one On/Off output would be connected to the ACTEON 5000. The washing activation signal activates Automatic Maintenance Mode for the relay and analog outputs (refer to sections 6.2.5 and 6.2.6). A note regarding the activation and ending of the washing shall be recorded in the Events log (refer to section 6.2.4).</p> <p><i>Event</i>: the functionality is similar to that of the washing function, however, in the events log this information shall be recorded with a note regarding the start and end of the event.</p> <p><i>Alert</i>: a functionality used to monitor an alarm function fitted to an external item of equipment. The activation of this function triggers Automatic Maintenance Mode for the relay and analog outputs (refer to sections 6.2.5 and 6.2.6). A note shall be included in the Events log of the start and end of the alert.</p>
I1: Release state	<p>NO (for Normally Open) NC (for Normally Closed)</p>
I2: Function	<p>Programming of On/Off Input No.2 (see above for the configuration of On/Off Input No.1)</p> <p>Inactive Washing Event Alert</p>
I2: Release state	<p>NO (for Normally Open) NC (for Normally Closed)</p>

6.2.3 Configuring the Analog inputs.

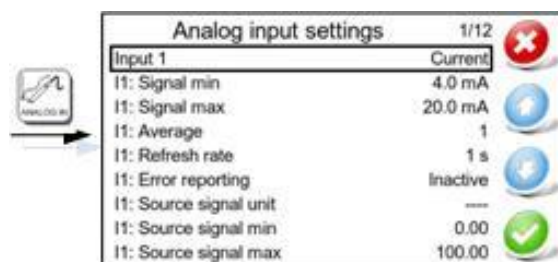

Set-up line	Functionality
Input 1	<p>Programming of Analog Input No.1: <i>Inactive</i> (no programmed action)</p> <p><i>Current</i>: if a sensor is connected which generates a signal of 0/4-20 mA</p> <p><i>Voltage</i>: if a sensor is connected which operates within a 0-10 V range</p>
I1: Signal min	<p>For a <i>Current</i> input: can be set to a value between 0 and 20 mA</p> <p>For a <i>Voltage</i> input: can be set to a value between 0 and 10V</p>
I1: Signal max	<p>For a <i>Current</i> input: can be set to a value between the minimum value set up in the "Signal min" line and 20 mA.</p> <p>For a <i>Voltage</i> input: can be set to a value between the minimum value set up in the "Signal min" line and 10 V.</p>
I1: Average	Used to set the number of measurements, from 1 (instantaneous value) to 50, from which the moving average is calculated.
I1: Refresh rate	This line lets the operator select the interval between each measurement. The possible values are: 1 to 60 seconds.
I1: Error reporting	<p><i>Inactive</i> (no error reporting)</p> <p><i>Out-of-range alert</i>: if the measurement falls outside of the range programmed by the Signal min and Signal max lines, information is sent to the relay output if the programming is set to "Alarm mode" (refer to section 6.2.6).</p>
I1: Source signal 1 units	<p>----- : units not selected</p> <p><i>mH₂O</i>: water height measurement sensor</p> <p><i>mbar</i>: pressure sensor</p> <p><i>bar</i>: pressure sensor</p>
I1: Source signal 1 min	This line lets the operator set the minimum value to between -9999.99 and 9999.9
I1: Source signal 1 max	This line lets the operator set the maximum value to between the minimum value set on the "Source signal 1 min" line and 9999.9.
I1: Source signal 1 display	<p>This line lets the operator arrange the information displayed on the home screen (refer to Table 2 for parameter display details)</p> <p><i>Not displayed</i></p> <p><i>Sens 1. Prim. Meas.</i>: the measurement shall be displayed in the space allocated to the primary parameter for sensor 1 (item 3 on the home screen)</p> <p><i>Sens 1. Sec. Meas.</i>: item 9 on the home screen.</p>

Sens 2. Prim. Meas.: item 6 on the home screen.
Sens 2. Sec. Meas.: item 13 on the home screen.

- I1: Source signal 1 desig.** ----- : no designation
Water height
Defined by User: in this case, an additional line will appear as soon as this option is confirmed
- I1: User desig.** A free text field for entering the user's designation (maximum of 13 characters).
- I1: Source signal 1 stability delta** Can be set from 0 to 50 % (the default is 1 %) and is used to define when the arrow on the home screen will indicate that the measurement is stable if the parameter measured has been set as the primary parameter for sensor 1 or 2 (refer to items 2 and 5 in Table 2)
- I1: Source signal 2** *Inactive*
Active: source signal 2 is calculated from source signal 1 by a conversion program written in a file stored on the USB stick plugged into the USB port.
- The name of the file must be of the form "CONFANA2.csv" and must contain the following information:
Line 1 of the csv file: a description (not more than 16 characters) of the calculated source signal.
Line 2: a blank line containing no characters.
Lines 3 to 32: a number of conversion points in the form of portions of a straight line $Source\ signal\ 2 = f(Source\ signal\ 1)$.
- To activate the conversion, plug the stick into the ACTEON 5000's USB port (refer to item 6 of diagram 3) and wait for the small green LED located above the USB port to stop flashing.
 Then navigate to menu I2: Source signal 2 and select the "Active" option.

If Source signal 2 is Activated

- I1: Source signal 2 display** *Not displayed*
Sens 1. Prim. Meas.: the measurement shall be displayed in the space allocated to the primary parameter for sensor 1 (item 3 on the home screen)
Sens 1. Sec. Meas.: item 9 on the home screen.
Sens 2. Prim. Meas.: item 6 on the home screen
Sens 2. Sec. Meas.: item 13 on the home screen.
- I1: Source signal 2 stability delta** Can be set from 0 to 50 % (the default is 1 %) and is used to define when the arrow on the home screen will indicate that the measurement is stable if the parameter measured has been set as the primary parameter for sensor 1 or 2 (refer to items 2 and 5 in Table 2)

Setting up Input 2

- Input 2** Programming of Analog Input No.2:
Inactive (no programmed action)
- Current:* if a sensor is connected which generates a signal of 0/4-20 mA
- Voltage:* if a sensor is connected which operates within a 0-10 V range
- I2: Signal min** For a *Current* input: can be set to a value between 0 and 20 mA
 For a *Voltage* input: can be set to a value between 0 and 10V
- I2: Signal max** For a *Current* input: can be set to a value between the minimum value set up in the "Signal min" line and 20 mA.

For a *Voltage* input: can be set to a value between the minimum value set up in the "Signal min" line and 10 V.

- I2: Average** Used to set the number of measurements, from 1 (instantaneous value) to 50, from which the moving average is calculated.
- I2: Refresh rate** This line lets the operator select the interval between each measurement. The possible values are: 1 to 60 seconds.
- I2: Error reporting** *Inactive* (no error reporting)

Out-of-range alert: if the measurement falls outside of the range programmed by the Signal min and Signal max lines, information is sent to the relay output if the programming is set to "Alarm mode" (refer to section 6.2.6).
- I2: Source signal 1 units** ----- : units not selected
mH₂O: water height measurement sensor
mbar: pressure sensor
bar : pressure sensor
- I2: Source signal 1 min** This line lets the operator set the minimum value to between -9999.99 and 9999.9
- I2: Source signal 1 max** This line lets the operator set the maximum value to between the minimum value set on the "Source signal 1 min" line and 9999.9.
- I2: Source signal 1 display** This line lets the operator arrange the information displayed on the home screen (refer to Table 2 for parameter display details)

Not displayed

Sens 1. Prim. Meas: the measurement shall be displayed in the space allocated to the primary parameter for sensor 1 (item 3 on the home screen)

Sens 1. Sec. Meas.: item 9 on the home screen

Sens 2. Prim. Meas: item 6 on the home screen

Sens 2. Sec. Meas.: item 13 on the home screen.
- I2: Source signal 1 desig.** ----- : no designation
Water height
Defined by User: in this case, an additional line will appear as soon as this option is confirmed.
- I2: User desig.** A free text field for entering the user's designation (maximum of 13 characters).
- I2: Source signal 1 stability delta** Can be set from 0 to 50 % (the default is 1 %) and is used to define when the arrow on the home screen will indicate that the measurement is stable if the parameter measured has been set as the primary parameter for sensor 1 or 2 (refer to items 2 and 5 in Table 2)
- I2: Source signal 2** *Inactive*

Active: source signal 2 is calculated from source signal 1 by a conversion program written in a file stored on the USB stick plugged into the USB port.

The name of the file must be of the form "CONFANA2.csv" and must contain the following information:

Line 1 of the csv file: a description (not more than 16 characters) of the calculated source signal.

Line 2: a blank line containing no characters

Lines 3 to 32: a number of conversion points in the form of portions of a straight line $\text{Source signal 2} = f(\text{Source signal 1})$.

To activate the conversion, plug the stick into the ACTEON 5000's USB port (refer to item 6 of diagram 3) and wait for the small green LED located above the USB port to stop flashing.

Then navigate to menu I2: Source signal 2 and select the "Active" option.

If Source signal 2 is Activated

I2: Source signal 2 display

Not displayed

Sens 1. Prim. Meas: the measurement shall be displayed in the space allocated to the primary parameter for sensor 1 (item 3 on the home screen)

Sens 1. Sec. Meas: item 9 on the home screen

Sens 2. Prim. Meas: item 6 on the home screen

Sens 2. Sec. Meas: item 13 on the home screen.









I2: Source signal 2 stability delta

Can be set from 0 to 50 % (the default is 1 %) and is used to define when the arrow on the home screen will indicate that the measurement is stable if the parameter measured has been set as the primary parameter for sensor 1 or 2 (refer to items 2 and 5 in Table 2)

6.2.4 Configuring the ACTEON 5000.



From the main menu, select the  icon to open the ACTEON 5000 settings window.

Icon	Functionality
	Screen settings: A menu used: to set how long the backlight stays on for (from 1 to 60 minutes); to set the brightness (from 10 to 100 %); and to recalibrate the screen. A screen recalibration is only necessary when ACTEON 5000 is switched on for the first time, or after a software upgrade.
	Hardware information: an information-only menu which displays the serial number and software version of the device, as well as the serial number, hardware version and model of the sensors connected to the device.
	Events log: an information-only menu which lists all the events together with their time-stamping and with the option to transfer this data to a USB stick via the  icon
	Date/time settings: a menu used to set the date and time, to choose the date format, and to enable/disable automatic summer/winter time change-over.
	Language: used to select the display language.
	Return to factory settings: used to reset all the ACTEON 5000's settings to the defaults set during manufacture.
	Password: Used to activate and define a password which prevents information from being displayed on the screen (a 4 digit code, between 0 and 9999). The universal emergency code is 3615 .

6.2.5 Configuring the Analog outputs.

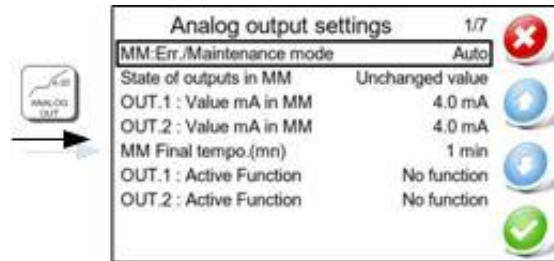

To access the "Analog output settings" window, select the  icon in the Main menu.

The functionality offered for the setting up of the two analog outputs is described in the table below:

Set-up line	Functionality
MM: Err/Maintenance mode	Used to set the Maintenance Mode to one of the following modes: Automatic (the default option, and which is activated when the calibration menu is used, or if there is a loss of communication, etc.) Inactive Manual (this mode is activated manually when maintenance or other work is performed on the device).
State of outputs in MM	In Maintenance Mode, the analog outputs may return a value corresponding to: - the last value measured, - a fixed (unchanged) value which shall be defined in the "OUT. 1: Value mA in MM" and "OUT. 2: Value mA in MM" lines.
OUT. 1: Value mA in MM	This line is used to set the value which will be returned by analog output 1 when the device is in Maintenance Mode (between 0 and 21 mA).
OUT. 2: Value mA in MM	This line is used to set the value which will be returned by analog output 2 when the device is in Maintenance Mode (between 0 and 21 mA).
MM Final tempo (mn)	Used to set a time delay which shall begin when the Maintenance is completed, to allow a period of time for the measurement to stabilize. The possible values are: 0 to 60 minutes (1 min is the default setting).
Configuration of the Analog Output 1	
OUT1 :Active function	Configuration of the output 1 according to 4 choices: No function Recorder Test – Fixed Value PID Controller
If Active Function : Recorder	
OUT 1: Active Function	This function activates analog output 1. Used to set output 1 to Data logger mode (for when the output is connected to a controller/data logger).
OUT. 1: DL type	Used to set output 1 to operate within a range of 0-20 mA or 4-20 mA.
OUT. 1: Parameter linked to DL	Used to select the parameter whose value shall be outputted via analog output 1: Sensor 1: Primary parameter Sensor 1: Secondary parameter Sensor 2: Primary parameter

Sensor 2: Secondary parameter

- OUT. 1: DL Min. value** Used to set the minimum value of output 1
- OUT. 1: DL Max. value** Used to set the maximum value of output 1
- OUT. 1: DL gain mA/s** Used to set the "responsiveness" of the 4-20 mA output. Possible value: 0 to 40 mA/s

If Active Function : Test fixed value

- OUT.1 : TEST Value mA** Possibility of simulation a value between 4.0 and 20.0 mA by step of 0.1 mA

If Active Function : PID Controller

- OUT.1 : PID Type** Used to set output 1 to operate within a range of 0-20 mA or 4-20 mA
- OUT.1 : PID linked param.** Used to select the parameter whose value shall be outputted for the PID function :
Sens.1.pri.meas
Sens.1.sec.meas
Sens.2.pri.meas
Sens.2.sec.meas
- OUT.1 : PID % Band** Configurable between 0.00 and 1000.00
Proportional to the gap between the measure and the instruction
- OUT.1 : PID Integral** Choice between Active (by fault) and Inactive

if OUT.1 : PID Integral: Active

- OUT.1 : PID Integral** Customizable between 0.00 and 1000.00 s

- OUT.1: PID Derivative** Choice between Inactive (by fault) and Active

If OUT.1 : PID Derivative : Active

- OUT.1: PID Derivative** Customizable between 0.00 and 1000.00 / s
- OUT.1: PID gain** Used to set the "responsiveness" of the 4-20 mA output. Possible value: 0 to 40 mA/s
- OUT.1: PID Direction** Configurable in Direct or Reversed Mode

Configuration of the Analog Output 2

- OUT2 :Active function** Configuration of the output 2 according to 4 choices:
No function
Recorder
Test – Fixed Value
PID Controller

If Active Function : Recorder

- OUT. 2: Active Function** This function activates analog output 2.
Used to set output 2 to **Data logger** mode (for when the output is connected to a controller/data logger).
- OUT. 2: DL type** Used to set output 2 to operate within a range of 0-20 mA or 4-20 mA.
- OUT. 2: Parameter linked to DL** Used to select the parameter whose value shall be outputted via analog output 2:

Sensor 1: Primary parameter
 Sensor 1: Secondary parameter
 Sensor 2: Primary parameter
 Sensor 2: Secondary parameter

OUT. 2: DL Min. value Used to set the minimum value of output 2
OUT. 2: DL Max. value Used to set the maximum value of output 2
OUT. 2: DL gain mA/s Used to set the "responsiveness" of the 4-20 mA output. Possible value: 0 to 40 mA/s

If Active Function : Test fixed value

OUT.2 : TEST Value mA Possibility of simulation a value between 4.0 and 20.0 mA by step of 0.1 mA

If Active Function : PID Controler

OUT.2 : PID Type Used to set output 2 to operate within a range of 0-20 mA or 4-20 mA

OUT.2 : PID linked param. Used to select the parameter whose value shall be outputted for the PID function :
 Sens.1.pri.meas
 Sens.1.sec.meas
 Sens.2.pri.meas
 Sens.2.sec.meas

OUT.2 : PID % Band Configurable between 0.00 and 1000.00

OUT.2 : PID Integral Choice between Inactive and Active

if OUT.2 : PID Integral: Active

OUT.2 : PID Integral Customizable between 0.00 and 1000.00 s

OUT.2: PID Derivative Choice between Inactive and Active

If OUT.2 : PID Derivative : Active

OUT.2: PID Derivative Customizable between 0.00 and 1000.00 / s

OUT.2: PID gain Used to set the "responsiveness" of the 4-20 mA output. Possible value: 0 to 40 mA/s

OUT.2: PID Direction Configurable in Direct or Reversed Mode

Maintenance Mode is activated under the following conditions:

- When a calibration is being performed,
- If communication with the sensor(s) is lost,
- If the measurement delivered by the sensor is incorrect,
- If an On/Off input in Washing Mode is activated.

6.2.6 Configuring the relay outputs.

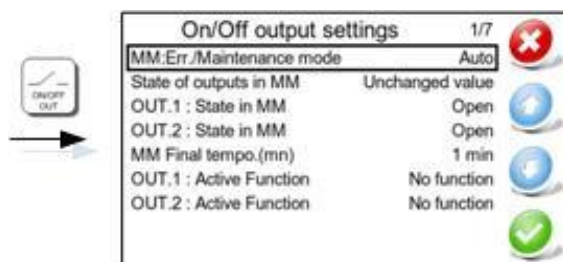

To access the "Relay output settings" window, select the  icon from the Main menu.

Set-up line	Functionality
MM: Err/Maintenance mode	Used to set the Maintenance Mode to one of the following modes: Automatic (the default option, and which is activated when the calibration menu is used, or if there is a loss of communication, etc.) Inactive Manual (this mode is activated manually when maintenance or other work is performed on the device).
State of outputs in MM	In Maintenance Mode, the relay outputs may remain set as: - the last value measured, - a fixed (unchanged) value which shall be defined in the "R1: State in MM" and "R2: State in MM" lines.
R1: State in MM	In Maintenance Mode, Relay 1 can be set to Open or Closed mode.
R2: State in MM	In Maintenance Mode, Relay 2 can be set to Open or Closed mode.
MM Final tempo (mn)	Used to set a time delay which shall begin when the Maintenance is completed. The possible values are: 0 to 60 minutes.

R1 output settings

R1: Active Function	Used to set output 1 to one of the following: Not assigned Fault alarm Limit indicator
----------------------------	---

If Active function: Fault alarm

R1: Alarm state	Relay can be set to Open or Closed mode.
R1: Alarm tempo (s)	A time delay which must elapse prior to the triggering of the relay. Possible values: 0 to 3600 s.

If Active function: Limit indicator

R1: Action	Relay can be set to Open or Closed mode.
R1: Linked parameter	Used to select the parameter linked to output 1: Sensor 1: Primary parameter Sensor 1: Secondary parameter Sensor 2: Primary parameter Sensor 2: Secondary parameter

Set-up line	Functionality
R1: Type of limit	Used to define the limit triggering mode:

Upper/overrange: when a limit is exceeded by being overshoot
 Lower/underrange: when a limit is exceeded by being undershot
 Interval: the range is set by a combination of upper and lower limits.

If Active function: Limit Indicator and Type of Limit (Upper/overrange or Lower/underrange)

R1: Limit Value	Used to set the value of the Upper or Lower limit
R1: Hysteresis limit %	Possible values: 0 to 20 %
R1: Tempo	Possible values: 0 to 3600 s

If Active function: Limit Indicator and Type of Interval limit

R1: UPPER limit value	Used to set the value of the UPPER limit
R1: Hysteresis limit %	Possible values: 0 to 20 %
R1: Tempo	Possible values: 0 to 3600 s
R1: Forcing Tempo	Minimum time during which the contact (CLOSED or OPEN) shall be maintained in that state (between 0 and 120 minutes)
R1: LOWER limit value	Used to set the value of the LOWER limit
R1: Hysteresis limit %	Possible values: 0 to 20 %
R1: Tempo	Possible values: 0 to 3600 s
R1: Forcing Tempo	Minimum time during which the contact (CLOSED or OPEN) shall be maintained in that state (between 0 and 120 minutes)

If Active Function: Test Mode / Fixed State

R1 : Etat mode test	Configurable relay in Open or Closed mode.
----------------------------	--

If Active System: External Cleaning

R1: hourly reference	Configurable between 0 and 23 hours
R1: hourly reference	Configurable between 0 and 59 minutes
R1: Unit of interval	Configurable in minutes, hour or day.
R1: Cleaning Period	If interval unit, above, defined in minute, the proposed minimum value is 5 minutes.
R1: duration of cleaning	Configurable between 0 and 300 seconds.
R1 : Action	Configurable relay in Open or Closed mode.

NOTE: The Closed action is selected when the wiring on the RELAY terminal block is done in NO (normally open).

If Active function: report TOR entry

R1: Action	Configurable relay in Open or Closed mode.
R1: Linked Entry	Configurable with Input TOR-1 or Input TOR-2
R1: Timeout	Configurable between 0 and 3600 seconds.

R2 output settings

R2: Active Function	Used to set output 1 to one of the following: Not assigned Fault alarm Limit indicator
----------------------------	---

If Active function: Fault alarm

R2: Alarm state	Relay can be set to Open or Closed mode
R2: Alarm tempo (s)	A time delay which must elapse prior to the triggering of the relay. Possible values: 0 to 3600 s

If Active function: Limit indicator

R2: Action	Relay can be set to Open or Closed mode
R2: Linked parameter	Used to select the parameter linked to output 2: Sensor 1: Primary parameter Sensor 1: Secondary parameter Sensor 2: Primary parameter Sensor 2: Secondary parameter

Set-up line Functionality

R2: Type of limit	Used to define the limit triggering mode: Upper/overrange: when a limit is exceeded by being overshoot Lower/underrange: when a limit is exceeded by being undershot Interval: the range is set by a combination of upper and lower limits.
--------------------------	--

If Active function: Limit Indicator and Type of Limit (Upper/overrange or Lower/underrange)

R2: Limit Value	Used to set the value of the Upper or Lower limit
R2: Hysteresis limit %	Possible values: 0 to 20 %
R2: Tempo	Possible values: 0 to 3600 s

If Active function: Limit Indicator and Type of Interval limit

R2: UPPER limit value	Used to set the value of the UPPER limit
R2: Hysteresis limit %	Possible values: 0 to 20 %
R2: Tempo	Possible values: 0 to 3600 s
R2: Forcing Tempo	Minimum time during which the contact (CLOSED or OPEN) shall be maintained in that state (between 0 and 120 minutes)
R2: LOWER limit value	Used to set the value of the LOWER limit

R2: Hysteresis limit %	Possible values: 0 to 20 %
R2: Tempo	Possible values: 0 to 3600 s
R2: Forcing Tempo	Minimum time during which the contact (CLOSED or OPEN) shall be maintained in that state (between 0 and 120 minutes)

If Active Function: Test Mode / Fixed State

R2 : Etat mode test Configurable relay in Open or Closed mode.

If Active System: External Cleaning

R2: hourly reference	Configurable between 0 and 23 hours
R2: hourly reference	Configurable between 0 and 59 minutes
R2: Unit of interval	Configurable in minutes, hour or day.
R2: Cleaning Period	If interval unit, above, defined in minute, the proposed minimum value is 5 minutes.
R2: duration of cleaning	Configurable between 0 and 300 seconds.
R2 : Action	Configurable relay in Open or Closed mode. NOTE: The Closed action is selected when the wiring on the RELAY terminal block is done in NO (normally open).

See also the paragraph detailing the use of the HYDROCLEAN-P motorized cleaning accessory coupled to the Nephelometric or optical oxygen turbidity sensor.

If Active function: report TOR entry

R2: Action	Configurable relay in Open or Closed mode.
R2: Linked Entry	Configurable with Input TOR-1 or Input TOR-2
R2: Timeout	Configurable between 0 and 3600 seconds.

Maintenance Mode is activated under the following conditions:

- When a calibration is being performed,
- If communication with the sensor(s) is lost,
- If the measurement delivered by the sensor is incorrect,
- If an On/Off input in Washing Mode is activated.

The conditions under which an On/Off input is activated in "Fault alarm" mode are:

- No response from sensor x parameter x,
- Poor response from sensor x parameter x,
- Out-of-range measurement for sensor x parameter x,
- Measurement not possible for sensor x parameter x,
- Low sensor power supply voltage,
- Low internal battery voltage,
- High internal temperature,
- Poor sensor communication response,
- On/Off input 1 alert
- Analysis of Actéon5000 program
- Low limit exceeded for analog input 1 or Upper limit exceeded for analog input 1
- On/Off input 2 alert
- Low limit exceeded for analog input 2 or Upper limit exceeded for analog input 2

6.2.7 Configuring the Recording output.

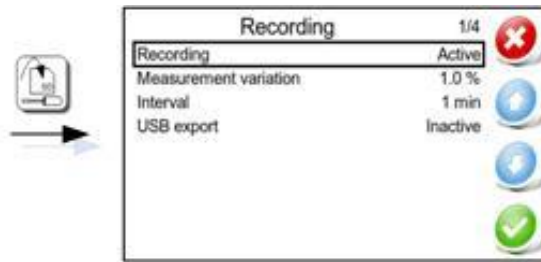

Set-up line	Functionality
Recording	<i>Inactive</i> : the recording function is not activated <i>Active</i> : this option activates the recording function
Measurement variation	Possible values: 0.0 to 50 %. The measurement will not be recorded if its variation (as a %) from the last recorded value does not meet this requirement. Default value 1%
Interval	The interval between consecutive recordings can be set from 1 to 120 minutes
USB export	<i>Inactive</i> <i>Active</i> : after connecting a USB stick, the data recorded on the ACTEON 5000 is copied to the latter. To download the recorded data, plug the stick into the ACTEON 5000's USB port (refer to item 6 of diagram 3) and wait for the small green LED located above the USB port to stop flashing. Navigate then to the "USB export" menu and select the "Active" option.

6.2.8 Configuration of digital outputs: Ethernet or RS485 MODBUS slave series.



This configuration page provides access to two types of digital output:

- Ethernet (TCP/IP modbus) on the client/server model,
- Serial (modbus RTU), Master/Slave.

The serial digital output is wired to the 3 dedicated contacts terminal block (ground, A and B), mark 8 in the figure in paragraph (3.2.2 Description wiring).

The Ethernet output uses a standard RJ45 base, mark 7 in the figure in paragraph (3.2.2 Description cabling).

6.2.8.1 Ethernet output (TCP/IP modbus):

Configuration line	Fonctionnalité
Ethernet	<i>Inactive</i> : this output is not enabled <i>Active</i> : enables this type of digital output
Ethernet Slave Number	Configurable from 1 to 254: the ACTEON 5000 on the network has a defined slave number that is different from other devices connected to the

- IP address 1/4 to 4/4** same network.
Fixed IP address of the equipment defined digitally in 4 fields.
Each field can be configured from 0 to 225.
Example:
IP1/4: 192
IP2/4: 168
IP3/4: 40
IP4/4: 40
Or an IP address of the equipment equal to 192.168.40.40.
BE CAREFUL NOT to assign an already occupied address of your network!
- Network mask** Definable, if necessary, also in 4 fields.
- Gateway** Definable, also in 4 fields, to describe the IP of the gateway of the local network used.

Note that the communication port is the default for modbus TCP: the 502.

NOTE: In a test phase if you connect your ACTEON with a live PC (RJ45 cable connecting the PC directly to the transmitter) make sure to assign an IP as well as a mask, to your PC, cohesive with the ACTEON. (see example below)

	ACTEON	PC
Network mask	255.255.255.0	255.255.255.0
IP (fixed)	192.168.40.40	192.168.40.1 (≠192.168.40.40)

6.2.8.2 Sortie série (modbus RTU) :

Configuration line	Fonctionnalité
Serial port	Inactive: this output is not enabled Active: enables this type of digital output
Serial port slave number	Configurable from 1 to 254: the ACTEON 5000 on the network has a defined slave number that is different from other devices connected to the same network.
Serial port speed	The speed of transmission represents the amount of information carried over a time interval. Units: bit per second or Bauds. Seven speed values are available from 2400 to 76800.
Serial port format	Four formats available for the frame: 8N2: 8bits, no parity, 2 stop bits, 8N1: 8bits, without parity, 1 stop bit, 8P1: 8bits, even, 1 stop bit, 8I1: 8bits, odd, 1 bit stop,

6.2.8.3 Table of data registers

The values measured by the two DIGISENS digital sensors connected to the ACTEON input are accessible remotely via the ACTEON digital output.
Regardless of the connected DIGISENS sensor, the data is classified into two fixed register ranges. Records are read-only.

Data format: floating IEEE754 (byteorder=Endian.Big, wordorder=Endian.Little)

The data is refreshed at the same rate as the one displayed on the screen (see configuration of the digital input, sensor 1 or 2).

	Measured parameter	Register
Sensor 1	temperature	30640
(lower modbus sensor address and display at the top of the screen)	Parameter 1	30642
	Parameter 2	30644
	Parameter 3	30646
	Parameter 4	30648
	Extended parameters (subject to availability)	30650 to 30670
Sensor 2	temperature	30672
(modbus address upper sensor and display in lower part of the screen)	Parameter 1	30674
	Parameter 2	30676
	Parameter 3	30678
	Parameter 4	30680
	Extended parameters (subject to availability)	30682 to 30702

Example: two connected DIGISENS sensors, OPTOD and STACSENSE

	Register	Measured parameter
Sensor 1 = OPTOD	30640	temperature
	30642	Oxygen (%sat)
	30644	Oxygen (mg/L)
	30646	Oxygen (ppm)
	30648	No data
	30650 to 30670	No data
Sensor 2 = STACSENSE	30672	temperature
	30674	SAC254
	30676	CODeq
	30678	BOCeq
	30680	TOCeq
	30682	Absorbance UV
	30684	Absorbance Green
	30686	Turbidity eq
	30688	Transmittance UV
	30690	Transmittance Green
	30692	No data
	30694	No data

7. Using the Motorized Cleaning Accessory HYDROCLEAN-P

Digital sensors OPTOD or nephelometric turbidity can be equipped with a motorized cleaning accessory, external to the sensor.

The temporal control of this HYDROCLEAN-P accessory can be configured on an ACTEON 5000. For this purpose, the HYDROCLEAN-P is connected to the RELAY terminal block of the ACTEON 5000.

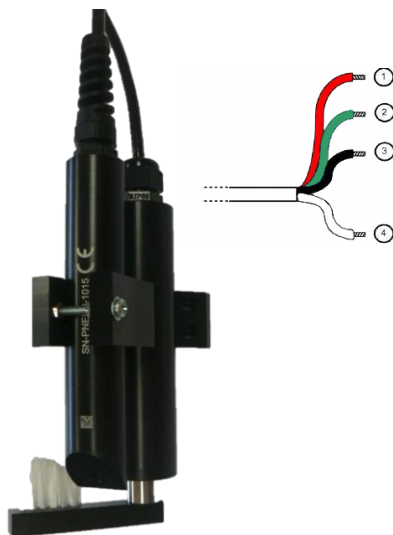
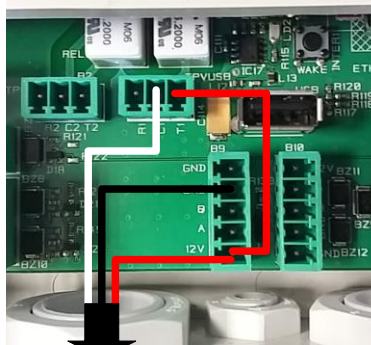

Detailed view of the terminal block area:
Digital relay input and output RS485

Wiring sketches:
12VDC Ground and Power from Second Digital
Input Terminal Block

Relay resumes 12VDC to obtain activation signal

Connection of the HYDROCLEAN-P:

- 1- Red/Rouge: V+ Power/Supply
- 2- Green/Green: Feedback
- 3- Black/Black: Ground/Ground
- 4- White/White: Trigger/Trigger

The relay used is then configured with the active function: System cleaning. External.

Action: Closed



Cleaning time: 2 seconds,

Cleaning period: 5 minutes minimum, to be defined according to the conditions of use.

8. Maintenance

8.1 Maintaining the transmitter:

Isolate the power to the measuring device when performing maintenance work.

	<p>Maintenance work must exclusively be carried out by authorized personnel.</p>
	<p>Due to the risk of electrocution, disconnect the controller from the power supply systematically when performing maintenance work on the transmitter.</p>

Do not use a corrosive or inflammable solvent to clean the transmitter. The use of this type of solvent could damage the device (its screen) and may invalidate the warranty.

After checking that the ACTEON 5000's protective covers are properly closed, wipe the outside of the transmitter with a soft cloth dampened with a mixture of water and non-corrosive detergent.

➤ **Replacing the lithium battery:**

The lithium battery cannot be replaced by the operator; contact the after-sales service.

8.2 Maintenance of digital sensors:

8.2.1 OPTOD sensor.

General description	<p>Oxygen: luminescent membrane sensitive to the oxygen level in the medium being analyzed. Gaseous exchange between the membrane's material and the medium.</p> <p>Temperature: NTC thermistor.</p>
Materials	<p>316L stainless steel version: polyamide, silicone and quartz; polyurethane sleeve around cable.</p> <p>Titanium version: polyamide, silicone and quartz; polyurethane sleeve around cable.</p>
Precautions	<p>The membrane is sensitive to:</p> <ul style="list-style-type: none"> - chemicals (organic solvents, acids, hydrogen peroxide), - mechanical stresses (impacts, abrasion, tearing).
Measurement/Interference	<p>When measuring, check that bubbles do not become trapped under the membrane.</p> <p>If chlorine is present, the quality of the measurement will be impaired (overestimate of the level of dissolved oxygen).</p> <p>When immersing the sensor in the medium to be measured, wait until the sensor's temperature has stabilized before taking the reading.</p> <p>To optimize the service life of the sensor, we recommend a measurement interval (refresh rate) of more than 5 seconds.</p>
Operating temperature	<p>0 °C to 50 °C</p> <p>Temperature compensation effective over the range 0-40 °C</p>
Servicing	<p>After each use, rinse the sensor and the membrane carefully in clean water. If deposits such as biofilm or sludge persist, wipe the membrane carefully with a soft cloth or absorbent paper.</p> <p>Caution: for the titanium version, clean the body of the sensor with acetone (do not use methylated spirits, ethanol or methanol).</p> <p>Caution: only unscrew the sieve cap containing the DODISK when replacing the disk.</p> <p>If the sieve cap has to be replaced, screw the new sieve cap on slowly to allow the air to escape slowly.</p>
Storage	<p>Keep the membrane hydrated using the protective bag and a dampened absorbent wad of material (e.g. cotton wool). After being stored in dry conditions, rehydrate the membrane for 12 hours by immersing the sensor in water.</p>
Storage temperature	<p>- 10 °C to + 60 °C</p>
Oxygen calibration	<p>Using a clean sensor, occasionally check the 0% Sat value by immersing the sensor in a sulfite solution in water (sulfite concentration <2%). If there is a zero error, perform a complete calibration of the sensor.</p> <p><i>Caution: do not allow the sensor to remain in contact with the sulfite solution for more than 1 hour.</i></p> <p>The 2-point calibration is performed using a sulfite solution (for the offset) then, after rinsing and drying, the sensor's gain is determined by exposing the sensor to moisture-saturated air (or to clean water saturated with air).</p>
Temperature calibration	<p>The calibration of the temperature sensor is a 2-step process:</p> <ul style="list-style-type: none"> - step 1 (offset): the sensor is placed in a container containing a water bath and ice,

- step 2 (gain): the sensor is placed in a medium (with an even temperature distribution in the medium) at a known temperature. This temperature may be measured using a certified thermometer.

8.2.2 NTU sensor: Turbidity.

General description	<p>Turbidity: nephelometric measurement by IR diffusion (wavelength: 880 nm) at 90°.</p> <p>Temperature: NTC thermistor.</p>															
Materials	PVC, PMMA, Polyamide, POM-C, polyurethane sleeve on cable															
Precautions	<p>The optical windows are sensitive to:</p> <ul style="list-style-type: none"> - chemicals (organic solvents, strong acids and bases, hydrogen peroxide, hydrocarbons), - mechanical stresses (impacts, abrasion). <p>When in use, the sensor must not come into contact with the sides or bottom of a container. Maintain a minimum distance of 2 or 3 cm between the sides and the sensor (depending on the concentration of the medium).</p>															
Measurement/Interference	<p>Bubbles on the optical components can interfere with the measurements. When immersing the sensor in the medium to be measured, wait until the sensor's temperature has stabilized before taking the reading.</p> <p>If measurements are being made in a range between 0 and 20 NTU, or if the sensor saturates (a value of 9999), it is advisable to use the protective sieve to avoid interference from edge effects, sunlight, etc.</p>															
Operating temperature	0 °C to 50 °C															
Servicing	<p>After each use, rinse the sensor carefully in clean water.</p> <p>If deposits such as biofilm or sludge persist, clean the sensor carefully with soapy water and wipe the head with a soft cloth or absorbent paper.</p>															
Storage	Place the protective bag over the head of the sensor to prevent the optical part from being scratched.															
Storage temperature	- 10 °C to + 60 °C															
Turbidity calibration (in NTU)	<p>The NTU sensor is an optical sensor which requires very little calibration. Using a clean sensor, occasionally check the 0 NTU value by immersing the sensor in clean, bubble-free water. If there is a zero error, perform a complete calibration of the sensor (over 1 or 4 measurement ranges).</p> <p>This procedure requires a formazine solution whose concentration lies at the mid-point of the measurement range being calibrated. This solution is prepared from a 4,000-NTU stock solution.</p> <p>Use a 200 ml volumetric flask when preparing the solutions. Add the required volume of formazine (refer to the table below) and make up to 200 ml with distilled water.</p> <p>Formazine solutions with concentrations of less than 1,000 NTU degrade fairly quickly; do not keep the solution for more than a few days. The 2,000 NTU solution can be kept for 2 to 3 weeks in a fridge in an opaque bottle.</p> <table border="1" style="width: 100%; border-collapse: collapse;"> <thead> <tr> <th>Measurement range</th> <th>Concentration of formazine standard solution</th> <th>Volume of formazine (mL)</th> </tr> </thead> <tbody> <tr> <td>0.0-50.0 NTU</td> <td>25 NTU</td> <td>1.25 mL</td> </tr> <tr> <td>0.0-200.0 NTU</td> <td>100 NTU</td> <td>5 mL</td> </tr> <tr> <td>0-1,000 NTU</td> <td>500 NTU</td> <td>25 mL</td> </tr> <tr> <td>0-4,000 NTU</td> <td>2,000 NTU</td> <td>100 mL</td> </tr> </tbody> </table>	Measurement range	Concentration of formazine standard solution	Volume of formazine (mL)	0.0-50.0 NTU	25 NTU	1.25 mL	0.0-200.0 NTU	100 NTU	5 mL	0-1,000 NTU	500 NTU	25 mL	0-4,000 NTU	2,000 NTU	100 mL
Measurement range	Concentration of formazine standard solution	Volume of formazine (mL)														
0.0-50.0 NTU	25 NTU	1.25 mL														
0.0-200.0 NTU	100 NTU	5 mL														
0-1,000 NTU	500 NTU	25 mL														
0-4,000 NTU	2,000 NTU	100 mL														

Turbidity calibration (in mg/L)

When a turbidity sensor is used to measure in a range whose units are mg/L, then the sensor must be calibrated using a field sample.

A 2-point calibration is performed:

- 1 offset using distilled water (0 mg/L),
- 1 gain using a sludge sample: immerse the sensor in the sample, with stirring, and log the theoretical value measured by the sensor. Using the same sample, analyze the dry weight in a laboratory in accordance with standard EN 872 within a range from 0-500 mg/L, and in accordance with standard NF T 90 105 2 if the concentration is > 500 mg/L.

Temperature calibration

Refer to section 7.2.1

8.2.3 PHEHT sensor: pH/Temperature.

General description	<p>pH/Redox: Potentiometric measurement; pH: a pair of electrodes; a reference (Ag/AgCl gel) and a glass bulb sensitive to H₃O⁺ ions Redox: a pair of electrodes; a reference (Ag/AgCl gel) and a platinum disk Temperature: NTC thermistor.</p>
Materials	Glass, platinum, PVC, POM-C, Polyamide, Stainless steel 316L (sleeve protecting the temperature sensor); polyurethane sleeve on cable.
Precautions	<p>The glass electrode is sensitive to:</p> <ul style="list-style-type: none"> - chemicals (organic solvents, strong acids and bases, hydrogen peroxide, hydrocarbons), - mechanical stresses (impacts). <p>The electrode that measures the Redox potential is sensitive to sulfides, which are adsorbed onto the platinum.</p>
Measurement/Interference	When immersing the sensor in the medium to be measured, wait until the sensor's temperature has stabilized before taking the reading.
Operating temperature	0 °C to 50 °C
Servicing	<p>After each use, rinse the sensor carefully in clean water.</p> <p>pH: If deposits such as biofilm or sludge persist, immerse the sensor in a cleaning solution (PF-CSO-C-00010) for a few hours and rinse with plenty of water before use.</p> <p>Do not use a soft cloth or absorbent paper since the glass bulb is extremely sensitive to scratching.</p> <p>Redox: clean the platinum disk using fine, wet abrasive paper (such as P1200 or P220).</p>
Storage	<p>Keep the glass membrane hydrated by adding a few drops of storage solution (PF-CSO-C-00005) to the protective bag, or using a solution at pH 4. Rinse the glass bulb with plenty of water before use. If the sensor is stored in dry conditions, soak the sensor in a pH4 buffer solution for 12 hours before use.</p> <p>The protective bag absorbs direct impacts on the head of the sensor.</p> <p>The platinum electrode is kept under dry conditions.</p>
Storage temperature	0 °C to + 60 °C
pH calibration	Using a clean sensor, perform a 2-point calibration of the sensor (offset and gain, e.g. at pH7 and pH4).
Redox verification	Using a clean sensor, check the electronic 0 by exposing the sensor to air, and check a second point using a buffer solution at 240 mV (or 470 mV).
Temperature calibration	Refer to section 7.2.1
Changing the cartridge	In order not to damage the electronic part of the sensor, hold the cartridge in one hand and unscrew the connecting ring using the other hand. Remove the used cartridge and insert the new cartridge before re-tightening the connecting ring.

8.2.4 ORP sensor: REDOX/Temperature.

General Description	Redox : a pair of electrodes with a reference (Ag/AgCl gel) /platinum ring Temperature : NTC.
Materials	Glass, platinum, PVC, Polyamide, DELRIN; polyurethane jacketed cable.
Safeway	The redox potential electrode is sensitive to sulphide adsorption on platinum.
Measurement/ Interference	During the introduction of sensor in the measurement environment, wait sensor's temperature stabilization before proceeding with measurement..
Operating temperature	0°C to 50°C
Maintenance	After each use, rinse meticulously the sensor with clear water. Clean the platinum ring with an abrasive moist paper (type P1200 or P220).
Storage	Maintain the head of the sensor hydrated in the protection case with a few drops of preservation agent solution (PF-CSO-C-00005) or, if it is not available, with the solution of KCl. Rinse profusely the sensor before use. After storage in dry environment, put the sensor in a KCl solution for 12 hours. The case protects against direct impact on the head of the sensor.
Storage temperature	0°C to + 60°C
Redox verification	Using a clean sensor, check the electronic 0 by putting the sensor in free air and a second point with standard solution at 240 mV (or 470 mV).
Temperature calibration	Refer to section 7.2.1
Changing the cartridge	To avoid deteriorating the electronic part of the sensor, take the cartridge in one hand and unscrew the clamping ring with the other hand. Remove the used cartridge and put the new cartridge before to screw back the clamping ring.

8.2.5 C4E sensor: 4-electrode conductivity.

General description	Conductivity: Amperometric measurement with a 4-electrode system; Temperature: NTC thermistor.										
Materials	Graphite, platinum, PVC, POM-C, Polyamide, Stainless steel 316L (sleeve protecting the temperature sensor); polyurethane sleeve on cable.										
Precautions	The 4 electrodes are sensitive to deposits (greases, hydrocarbons, biofilm, sludges).										
Measurement/Interference	When immersing the sensor in the medium to be measured, wait until the sensor's temperature has stabilized before taking the reading.										
Operating temperature	0 °C to 50 °C										
Servicing	After each use, rinse the sensor carefully in clean water. If deposits such as biofilm or sludge persists in the measurement slit or on the electrodes, use wet abrasive paper to remove a thin layer off the surface of the electrodes (type P1200 or P220).										
Storage	The protective bag absorbs direct impacts on the head of the sensor. If storing for a short period between measurements, place a wad of cotton wool in the bottom of the storage bag, dampened with a few drops of buffer solution at 1,413 $\mu\text{S}/\text{cm}$.										
Storage temperature	- 10 °C to + 60 °C										
Conductivity calibration	Using a clean sensor, perform a 2-point calibration of the sensor (offset and gain using a standard solution whose conductivity is suited to the measurement range) for 1 or all 4 ranges:										
	<table border="1"> <thead> <tr> <th>Measurement range</th> <th>Concentration of the standard conductivity solution</th> </tr> </thead> <tbody> <tr> <td>0.0-200.0 $\mu\text{S}/\text{cm}$</td> <td>84 $\mu\text{S}/\text{cm}$</td> </tr> <tr> <td>0-2,000 $\mu\text{S}/\text{cm}$</td> <td>1,413 $\mu\text{S}/\text{cm}$</td> </tr> <tr> <td>0.00-20.00 mS/cm</td> <td>12.88 mS/cm</td> </tr> <tr> <td>0.0-200.0 mS/cm</td> <td>111.8 mS/cm</td> </tr> </tbody> </table>	Measurement range	Concentration of the standard conductivity solution	0.0-200.0 $\mu\text{S}/\text{cm}$	84 $\mu\text{S}/\text{cm}$	0-2,000 $\mu\text{S}/\text{cm}$	1,413 $\mu\text{S}/\text{cm}$	0.00-20.00 mS/cm	12.88 mS/cm	0.0-200.0 mS/cm	111.8 mS/cm
Measurement range	Concentration of the standard conductivity solution										
0.0-200.0 $\mu\text{S}/\text{cm}$	84 $\mu\text{S}/\text{cm}$										
0-2,000 $\mu\text{S}/\text{cm}$	1,413 $\mu\text{S}/\text{cm}$										
0.00-20.00 mS/cm	12.88 mS/cm										
0.0-200.0 mS/cm	111.8 mS/cm										
Temperature calibration	Refer to section 7.2.1										

8.2.6 CTZN sensor: Inductive conductivity.

General description	Conductivity: inductive measurement technology; Temperature: NTC thermistor.								
Materials	EPDM, PVC, 316L stainless steel (sleeve protecting the temperature sensor); polyurethane sleeve on cable.								
Precautions	This measuring technology is not sensitive to fouling. However, ensure that the loop is not obstructed.								
Measurement/Interference	When immersing the sensor in the medium to be measured, wait until the sensor's temperature has stabilized before taking the reading. The sensor is not well suited to measuring in the weakest ranges (0-200 $\mu\text{S/cm}$).								
Operating temperature	0° C to 50 °C								
Servicing	After each use, rinse the sensor carefully in clean water.								
Storage	The sensor should be dried before being stored.								
Storage temperature	- 10 °C to + 60 °C								
Conductivity calibration	Using a clean sensor, perform a 2-point calibration of the sensor (offset and gain using a standard solution whose conductivity is suited to the average value expected): <table border="1" data-bbox="558 1097 1177 1384"> <thead> <tr> <th>Measurement range</th> <th>Concentration of the standard conductivity solution</th> </tr> </thead> <tbody> <tr> <td>0-2,000 $\mu\text{S/cm}$</td> <td>1,413 $\mu\text{S/cm}$</td> </tr> <tr> <td>0.00-20.00 mS/cm</td> <td>12.88 mS/cm</td> </tr> <tr> <td>0.-100.0 mS/cm</td> <td>20.00 mS/cm</td> </tr> </tbody> </table>	Measurement range	Concentration of the standard conductivity solution	0-2,000 $\mu\text{S/cm}$	1,413 $\mu\text{S/cm}$	0.00-20.00 mS/cm	12.88 mS/cm	0.-100.0 mS/cm	20.00 mS/cm
Measurement range	Concentration of the standard conductivity solution								
0-2,000 $\mu\text{S/cm}$	1,413 $\mu\text{S/cm}$								
0.00-20.00 mS/cm	12.88 mS/cm								
0.-100.0 mS/cm	20.00 mS/cm								
Temperature calibration	Refer to section 7.2.1								

8.2.7 VB5 – MES 5 sensor: Sludge blanket detection – Sludge blanket detection/Suspended Solid/Turbidity.

Description	Optical IR (870 nm) based on IR absorption Temperature: NTC.															
Materials	DELRIN, Nickel-plated brass, EPDM ; Polyurethane jacketed cable															
Safeway	The optical windows are vulnerable to: chemicals (organic solvents, acids and strong bases, peroxide, hydrocarbons), mechanical treatments (impact, abrasion).															
Measure/ Interfering	Bubbles on optical parts can interfere with the measurement. On environment change, wait sensor's temperature stabilization before proceeding with measurement.															
Operating temperature	0°C to 50°C															
Maintenance	After each use, rinse meticulously the sensor with clear water. If deposits like biofilm or mud persist, clean the sensor with soapy water and wipe the head with a soft cloth or an absorbent paper.															
Storage	Place the protection case on the head of the sensor with a bottom of water to maintain the hydrated optical windows.															
Temperature of storage	- 10°C to + 60°C															
Turbidity calibration in FAU	<p>On a clean sensor, check once in a while the 0 NTU value by dipping sensor in bubble free clear water. If the 0 point is shifted, proceed with the complete sensor calibration (on 1 or 4 ranges).</p> <p>For this procedure, a Formazin solution, with concentration matching the middle of the measurement range, will be necessary. This solution will be prepared from a 4000 NTU main solution.</p> <p>For the preparation of solutions, take a flask of 200 mL. Introduce the necessary volume of Formazin (cf. table below) and fill up to 200 mL with distilled water.</p> <p>The formazin solutions of concentrations lower at 1000 NTU deteriorate quickly, so do not preserve a solution during several days.</p> <p>The solution at 2000 NTU can be preserve in the refrigerator for 2 or 3 weeks in a opaque flask.</p> <table border="1" data-bbox="443 1328 1481 1552"> <thead> <tr> <th>Measurement range</th> <th>Concentration Formazin solution</th> <th>Volume of Formazin (mL)</th> </tr> </thead> <tbody> <tr> <td>0.0-50.0 FAU</td> <td>25 NTU</td> <td>1,25 mL</td> </tr> <tr> <td>0.0-200.0 FAU</td> <td>100 NTU</td> <td>5 mL</td> </tr> <tr> <td>0-1000 FAU</td> <td>500 NTU</td> <td>25 mL</td> </tr> <tr> <td>0-4000 FAU</td> <td>2000 NTU</td> <td>100 mL</td> </tr> </tbody> </table>	Measurement range	Concentration Formazin solution	Volume of Formazin (mL)	0.0-50.0 FAU	25 NTU	1,25 mL	0.0-200.0 FAU	100 NTU	5 mL	0-1000 FAU	500 NTU	25 mL	0-4000 FAU	2000 NTU	100 mL
Measurement range	Concentration Formazin solution	Volume of Formazin (mL)														
0.0-50.0 FAU	25 NTU	1,25 mL														
0.0-200.0 FAU	100 NTU	5 mL														
0-1000 FAU	500 NTU	25 mL														
0-4000 FAU	2000 NTU	100 mL														
Suspended Solid calibration in g/L	<p>Turbidity in g / L, it is necessary to calibrate the sensor on a real sample. The calibration is achieved in 2 steps :</p> <ul style="list-style-type: none"> - Step 1 (offset) : immerse the sensor in distilled water (0 mg / L), - Step 2 (slope) : immerse the sensor into a sample of sludge, maintained under agitation, and validate the theoretical value measured by the sensor. Analysis the sample dry weight in the laboratory according to the NF standard T 90 105 2. 															
Sludge blanket detection in %	<p>For a use of the sensor in mode Sludge Blanket detection the sensor is tested on 1 point:</p> <ul style="list-style-type: none"> - 1 offset with some distilled water (100 %) 															
Temperature calibration	Refer to section 7.2.1															

8.2.8 StacSense probe.

Description	Measurement by UV absorptiometry (wavelength 245+/-5 nm). Turbidity correction, green radiation absorptiometry 530+/-5nm Temperature: NTC.												
Material	Body: stainless steel 316L(1.4401); optical windows Quartz(Corning 7980)POM-C, cable sheathed Polyurethane, seals: fluoro-elastomer (FPM/FKM) Optical windows are sensitive to aggression: - chemicals (organic solvents, acids and strong bases, hydrogen peroxide, hydrocarbons), - mechanical (shock, abrasion).												
Safeway	- Body: stainless steel 316L(1.4401); optical windows Quartz(Corning 7980)POM-C, cable sheathed Polyurethane, seals: fluoro-elastomer (FPM/FKM) Optical windows are sensitive to aggression: - chemicals (organic solvents, acids and strong bases, hydrogen peroxide, hydrocarbons), - mechanical (shock, abrasion). The presence of bubbles on the optical parts may interfere with the measurement.												
Measure/ Interfering	When introducing the sensor into a measuring medium, wait for the sensor to stabilize at temperature before taking the measurement into account.												
Operating temperature	0°C to 40 °C												
Maintenance	After each use, rinse the sensor thoroughly with clean water. If biofilm or mud deposits persist, clean the sensor with soapy water and wipe the optical windows with a soft cloth or absorbent paper.												
Storage	The sensor is kept dry after complete cleaning.												
Temperature of storage	- 10°C to + 50°C												
CAS calibration in 1/m	For use of the Stacsense sensor in SAC 254 (spectral absorption coefficient) in 1/m, it is necessary to calibrate the sensor in clear water, without bubble, stabilized in temperature. Calibration is performed in 2 steps in the same sample: - step 1, clear water, active UV light source, - step 2, clear water, active green light source.												
Equivalent Turbidity parameter	The sensor provides equivalent turbidity information in FAU. This parameter is not calibratable (factory determined slope coefficient). However, the clear water sequence of SAC 254 with active green light source allows an adjustment of the base signal.												
Parameters CODEq, BODEq and TOCEq	The equivalence parameters COD, BOD and TOC are calculated from the main parameter SAC254 according to a refined law. The user accesses the independent coefficients (offset and slope) for each of these three parameters. The Stacsense sensor stores the factory coefficients below. These basic coefficients are accessible at any time by means of the return function to the factory coefficients												
<table border="1"> <thead> <tr> <th>Parameter</th> <th>offset FACTORY</th> <th>Slope FACTORY^(a)</th> </tr> </thead> <tbody> <tr> <td>CODEq</td> <td>0,0</td> <td>1,81</td> </tr> <tr> <td>BODEq</td> <td>0,0</td> <td>0,48</td> </tr> <tr> <td>TOCEq</td> <td>0,0</td> <td>0,72</td> </tr> </tbody> </table>		Parameter	offset FACTORY	Slope FACTORY ^(a)	CODEq	0,0	1,81	BODEq	0,0	0,48	TOCEq	0,0	0,72
Parameter	offset FACTORY	Slope FACTORY ^(a)											
CODEq	0,0	1,81											
BODEq	0,0	0,48											
TOCEq	0,0	0,72											
<small>(a) Slope values obtained in KHP (potassium hydrogen phthalate) solution in the laboratory.</small>													
Via the «Calibration management» menu (general menu/DIGITAL IN/CAL/sensor 1 or 2/CAL), the user can access the CODEq, BODEq or TOCEq parameter. This selection													

gives immediate access to the current coefficients, offset and slope. Each line is editable to change the value of the coefficient.

When the operator name is filled in, the ACTION button  appears to inject the coefficients values into the StacSense sensor.

For example, the user determines these own coefficients of the CODEq refining law from representative samples, measured both with the StacSense sensor (active factory coefficients) and in the laboratory (standardized method).

**Temperature
calibration**

Refer to section 7.2.1

9. Troubleshooting

Fault	Resolution
Sensor not recognized, Short lines displayed instead of the measurement	<ul style="list-style-type: none"> - Make sure that the sensor has been connected up correctly. - Run a SCAN of the network of sensors (refer to section 5.2). - Disconnect the sensor and connect it to the other digital input dedicated to the sensor. - Contact the technical services department.
Unstable measurements	<ul style="list-style-type: none"> - Check that the sensor has been installed under the correct conditions. - Clean the sensor and check the measuring elements (active disk for the OPTOD sensor, cartridge/glass bulb for the PHEHT sensor, etc.) - Run a calibration of the sensor. - Contact the technical services department.
Measurement displayed as 9999	<p>Out-of-range measurement:</p> <ul style="list-style-type: none"> - Check that the sensor has been installed under the correct conditions. - Clean the sensor. - Run a calibration of the sensor. - Contact the technical services department.
Current output not working, or value incorrect	<ul style="list-style-type: none"> - Check the settings for the current output. - Check that the wiring is correct. - Check that the device is not in Maintenance Mode. - Disconnect the faulty analog output and connect it to the other analog output. - Contact the technical services department.
No relay activation	<ul style="list-style-type: none"> - Check the settings for the relay output. - Check that the wiring is correct. - Check that the device is not in Maintenance Mode. - Disconnect the faulty relay output and connect it to the other relay output. - Contact the technical services department.
Frozen screen	<p>Press the RESET button on the connection hardware part of the circuit card (refer to item A in diagram 3).</p>

After-Sales Service

AQUALABO
115 Rue Michel MARION
56850 CAUDAN
FRANCE

Tél : +33 (0)1 72 87 97 93
Fax: +33 (0)2 97 76 55 72
Email : sav.ponsel@aqualabo.fr