



User Manual



UNI Sustainable Single Gas Detector

Contents

Contents	2
Description	3
Warning	3
Proper Disposal	3
1 Product Overview	4
2 Activation	5
2.1 Switch On	5
2.2 Warm Up Sequence	5
3 Mode	6
3.1 Normal Mode	6
3.1.1 Min Screen (for Oxygen sensor only)	6
3.1.2 Turn unit off	6
3.2 Config Mode	7
3.2.1 Enter Config Mode	7
3.2.2 Sensor Calibration	7
3.2.3 Calibration Adapter	7
3.2.4 Zero Calibration	8
3.2.5 SPAN Calibration	8
3.2.6 Bump Test	8
3.2.7 Change Alarm Limit	8
3.2.8 Change Bump/CAL Interval	9
3.2.9 Change SPAN Value	9
3.2.10 Vibrator enable/disable	9
3.2.11 Power On Zero enable/disable	9
3.2.12 Fast Power enable/disable	10
3.2.13 Reset Config	10
3.2.14 Exit Config Mode	10
4 Maintenance	10
4.1 Replace the battery	10
4.2 Replace the Sensor Filter	11
4.3 Replace the Sensor	11
5 Alarm Signal Summary	13
6 Trouble shooting	14
7 Specifications	15
8 Limited Warranty	17

Description

The UNI Sustainable is a single sensor, portable, personal toxic gas monitor. It displays gas concentration continuously on a big segment LCD. It also monitors STEL, TWA, peak and min (for O₂ only) value of the gas and can be displayed on demand. High, Low, STEL&TWA alarm threshold values are configurable. The shell is made of high strength, durable material. Two key operation, simple to use. Sensor and battery can be replaced easily. Calibration is also very convenient.



Warning

This manual must be carefully read by all individuals who have or will have the responsibility of using, maintaining or servicing this product. The product will perform as designed only if it is used, maintained and serviced in accordance with the manufacturer's instructions.

- Never operate the monitor when the cover is removed.
- Remove the monitor cover and battery only in area known as non-hazardous.
- Use only WatchGas lithium battery.
- This instrument has not been tested in an explosive gas/air atmosphere having an oxygen concentration greater than 21%.
- Substitution of components will impair suitability for intrinsic safety.
- Substitution of components will void warranty.
- It is recommended to bump test with a known concentration gas to confirm the instrument is functioning properly before use.
- Before use, ensure that the ESD film on the display is not damaged or peeling.

Proper Disposal

The Waste Electrical and Electronic Equipment(WEEE) directive (2012/19/EU) is intended to promote recycling of electrical and electronic equipment and their components at end of life . This symbol (crossed-out wheeled bin) indicates separate collection of waste electrical and electronic equipment in the EU countries. This product may contain one or more Nickel-metal hydride (NiMH), Lithium-ion, or Alkaline batteries. Specific battery information is given in this user guide. Batteries must be recycled or disposed of properly. At the end of its life, this product must undergo separate collection and recycling from general or household waste. Please use the return and collection system available in your country for the disposal of this product.

1. Product Overview

DETECTOR COMPONENTS

1. Audible Alarm Port
2. LED alarm window
3. LCD
4. Left Key (Confirm/Number increasing)
5. Right Key (Power/ Cursor moving)
6. Alligator clip
7. Sensor
8. Vibrator



DISPLAY SYMBOLS

1. Gas name, includes: CO, H₂S, SO₂, O₂, VOC
2. Question mark
3. OK
4. Gas unit, includes: x10⁻⁶, ppm, %, mg/m³, μmol/mol
5. Battery
6. HIGH, LOW, STEL, TWA alarm
7. Span calibration
8. Zero calibration
9. Number

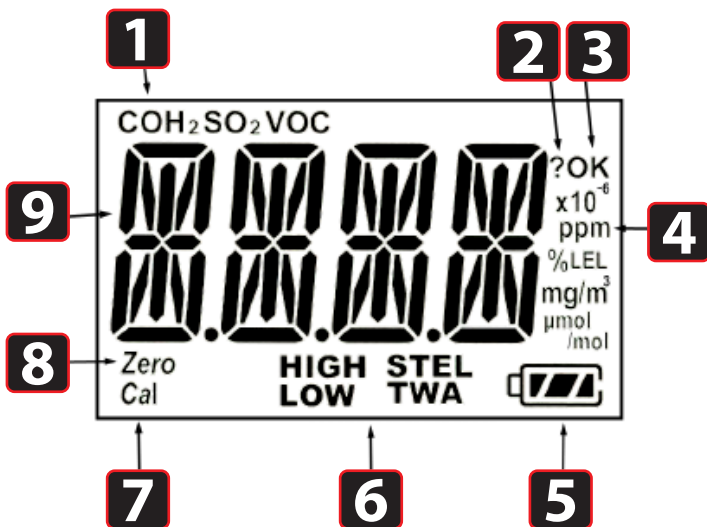

2. Activation

2.1 SWITCH ON

Press and hold the Right Key for 3 seconds, until LCD displays (000), buzzer beeps, green LED flashes, then release the button, the unit is powered on.

2.2 WARM UP SEQUENCE

After powered on, the unit enters a warm up and self-test sequence and shows the firmware version as follows:

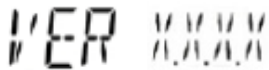

If the sensor is not able to be identified by the instrument or is not installed into the instrument,

then the screen switches between **SEN** and **Errr**. Otherwise, the following values will be shown accordingly:



High alarm threshold value

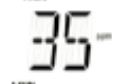

Low alarm threshold value



STEL (short-term exposure limit) alarm threshold value



TWA (time-weighted average) alarm threshold value

3. Mode

3.1. NORMAL MODE

The unit enters normal mode, start monitoring gas concentration and display on the LCD screen.



User can check some other values like STEL, TWA, PEAK, and MIN (for O₂ only) by pressing the Right Key.

*Unit will return to real time reading from any other screen when there's no key action for 60 seconds.



STEL screen

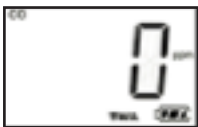

TWA screen



PEAK screen

Press the Left Key to clear peak value



Press the Left Key again, peak value is cleared.

3.1.1 MIN SCREEN (FOR OXYGEN SENSOR ONLY)

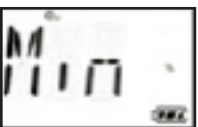

Press the Left Key to clear min value



Press the Left Key again, minimum value is cleared



Press the Left Key again, minimum value is cleared

3.1.2 TURN UNIT OFF

In normal display mode, press and hold the Right Key, then the unit will display a 5 second count down, LEDs will flash and buzzer will beep once per second.

3.2 CONFIG MODE

In Config mode, user can do calibration & change parameters for the unit. In general, use the Left Key to increase the number or confirm, use the Right Key to move the cursor or move to the next programming item.

3.2.1. ENTER CONFIG MODE

Press and hold the Left Key and the Right Key together for 3 seconds, the unit enters Config mode. The Config mode is password protected, LCD displays **PWD** to prompt enter password. The screen displays **0000**, with one digit flashing.

To input password, use the Left Key to increase the number, use the Right Key to move cursor. Once all four digits are input, the cursor will move to "OK", use the Left Key to finish password input and enter the Config mode. If the digit input is mistaken, use the Right Key to move cursor between four digits and "OK" mark, to change the input.

*WatchGas Sustainable preset password is 0000.

3.2.2. SENSOR CALIBRATION

Before the unit can monitor gas correctly, it needs to know the metric, this is done by zero calibration and span calibration.

3.2.3 CALIBRATION ADAPTER

1. Calibration adapter is used to apply gas to the unit during calibration.
2. Before span calibration (in the following section), attach the Calibration Adapter over the inlet port on the front of the UNI Sustainable by pressing it into place.

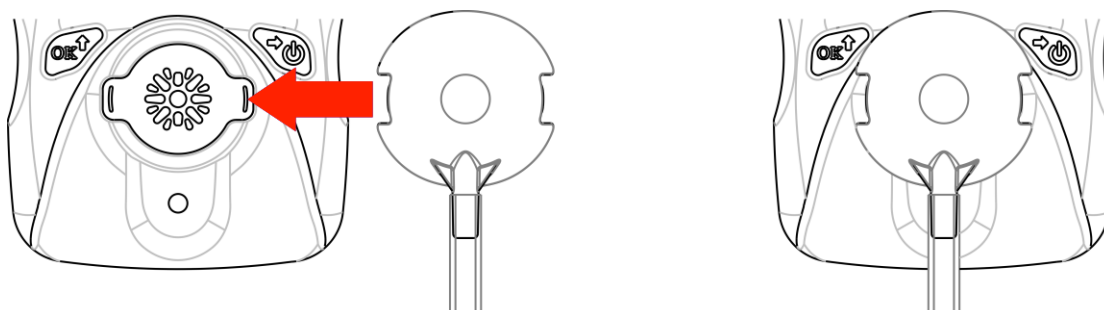

3. Open the gas cylinder valve, then press the Left Key to start the calibration count down.

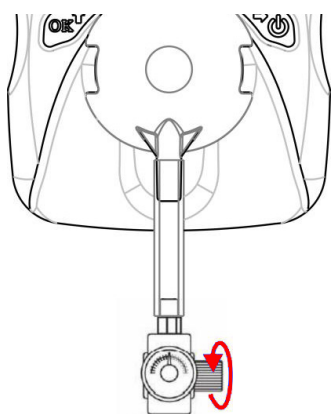

4. Take off the Calibration Adapter and complete calibration.

When monitoring, never operate the UNI Sustainable with the Calibration Adaptor attached. The UNI Sustainable's sensor operates by diffusion. If the Calibration Adapter is attached during normal operation, inconsistent and lower-than-normal readings will occur because of decreased concentration of the gas being monitored.

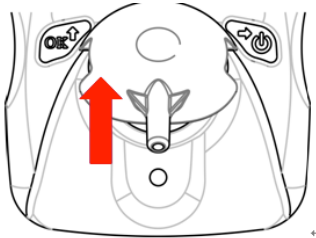

3.2.4 ZERO CALIBRATION

Zero calibration is to set the base line for the sensor, it is done in fresh air. When LCD displays **ZERO** press the Left Key to start zero calibration. The unit will start a 15 second count-down, after the count-down is finished, zero calibration result will be displayed on the LCD, pass **PASS** or fail **FAIL**. If user does not want to do zero calibration, during the 15 seconds count, press the Right Key, **ABRT**, zero calibration is aborted.

3.2.5 SPAN CALIBRATION

Span calibration is to set the metric of the sensor to the gas, it is done with a known concentration gas. When LCD displays **SPAN** apply the known gas to the unit, then press the Left Key to start span calibration. Unit will start count-down, the count-down time depends on different sensors (normally 60 seconds), after count-down is finished, span calibration result will pass **PASS** or fail **FAIL**. If user does not want to do span calibration during count-down, press the Right Key, LCD displays **ABRT**, span calibration is aborted.

3.2.6 BUMP TEST

Bump test is to check if sensor and alarm devices are working properly, it is done with a known concentration gas. When LCD displays **BUMP**, apply the known gas to the unit, then press the Left Key to start bump test. Unit will start count-down, the count-down time depends on different sensors (normally 45 seconds), after count-down is finished, bump test result will be displayed on the LCD, pass **PASS** or fail **FAIL**. If user does not want to do bump test during count-down, press the Right Key, LCD displays **ABRT**, bump test is aborted.

3.2.7 CHANGE ALARM LIMIT

All the preset alarm limits, High, Low, STEL & TWA can be changed. When LCD displays:



Press the Left Key, to change the corresponding alarm limit, the value change process is similar. First the current setting value is displayed, with the first digit flashing: **0000**.

Use the Left Key to increase the current digit, **1000**, cycle from 0 to 9.



Use the Right Key to move cursor to the next digit: **0000**

After all digits are done, use the Right Key to move cursor to "OK" symbol,  press the Left Key to confirm the changing.

- * The UNI Sustainable will show "Err", if the input data is invalid as follows,
 - Low alarm setting is bigger than high alarm setting.
 - High alarm setting is smaller than low alarm setting.
 - Input data is bigger than measuring range.

3.2.8 CHANGE BUMP/CAL INTERVAL

The bump and cal interval can also be changed. When LCD switches between:

 and .

Press the Left Key, to change the corresponding interval range, the value change process is similar. First the current setting value is displayed, with the first digit flashing: .

Use the Left Key to increase the current digit, , cycle from 0 to 9.

Use the Right Key to move cursor to the next digit: .

After all digits are done, use the Right Key to move cursor to "OK" symbol,  press the Left Key to confirm the changing.

- * The UNI Sustainable will show "Err", if the input data is out of valid range: 0~180 day(s).

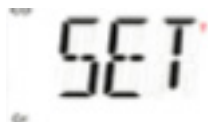

3.2.9 CHANGE SPAN VALUE

The span calibration preset value can also be changed, the change process is similar with the alarm limit. But the new span will not take effect until user successfully completes a span calibration next time.









- * UNI Sustainable will show "Err", if the input data is invalid as follows:
 - Span setting is smaller than 5% measuring range or bigger than measuring range.
 - For Oxygen sensor, span setting is bigger than 19.0.

3.2.10 CHANGE DISPLAY UNIT

The UNI Sustainable supports different gas units, to change gas unit, when LCD switches between  and , press the Left Key to change gas unit. The supported units for current sensor are all displayed on the LCD, the current selected unit is blinking. Use the Right Key to change unit, use the Left Key to confirm selected gas unit.

3.2.11 VIBRATOR ENABLE/DISABLE

The vibrator consumes a lot of power, it can be disabled to save battery power, to extend the battery life. When LCD switches between  and , press the Left Key to change the vibrator enable/disable status. The current vibrator status is displayed on the LCD, switching between  and  if the vibrator is enabled, or switching between  and , if the vibrator is disabled. Use the Right Key to change the enable/disable status, and use the Left Key to confirm the change.

3.2.12. POWER ON ZERO ENABLE/DISABLE

Sensor base line may have some changes due to the environment (temperature, humidity), that will require a zero calibration. Mthe Uni Sustainable can do zero calibration every time the unit is powered on; this feature can be enabled/disabled.

When LCD switches between *P-on* and *SET*, press the Left Key to go to change power on zero calibrations enable/disable status. The current enable/disable status is displayed on the LCD, use the Right Key to change, use the Left Key to confirm the change.

3.2.13 FAST POWER ON ENABLE/DISABLE

If fast startup is enabled, the screens showing High/Low/STEL/TWA alarm threshold value will be skipped during warm up sequence.

When LCD switches between *FAST* and *SET*, press the Left Key to change fast startup enable/disable status. The status is displayed on the LCD, switching between *FAST* and *on* if the fast startup is enabled, or switching between *FAST* and *off* if the fast startup is disabled. Use the Right Key to change the enable/disable status, use the Left Key to confirm the change.

3.2.14. RESET CONFIG

If the unit parameter is incorrect and user does not know how to set them back, user can use reset config to make all the parameters back to factory default.

When LCD switches between *RST* and *CFG*, press the Left Key to enter config reset menu, press the Left Key to confirm config reset.

3.2.15. EXIT CONFIG

When LCD displays *EXIT*, press the Left Key exit from Config mode back to normal mode.

4. Maintenance

Caution

Maintenance should be performed only by a qualified person who has proper training and fully understands the contents of the manual.

4.1 REPLACE THE BATTERY

When the battery's charge is low, LCD displays , battery low alarm will be triggered once every minute. User needs to replace the battery.

When battery is dead, LCD displays *BAT LOW*, battery dead alarm will be triggered once every second. User needs to replace the battery.

To replace battery:

- 1 Turn off the UNI Sustainable.
- 2 Place the UNI Sustainable face down on a soft surface.
- 3 Use a T10 Torx screwdriver to loosen each of the four screws by turning them counterclockwise.
- 4 Remove the top cover after carefully unplugging the buzzer connector.
- 5 Slide the battery out of its compartment.
- 6 Place the new battery into the compartment with its "+" end oriented toward the "+" on the printed circuit board.
- 7 Plug in the buzzer connector and reinstall the top cover.
- 8 Install the screws in back cover. Be careful to not overtighten the screws

4.2 REPLACE THE SENSOR FILTER

A "peel-and-stick" filter should be used on the UNI Sustainable in order to keep debris from fouling the sensor. Sheets of 5 filters are available. When the filter appears dirty, replace it with a new one and dispose of the dirty filter.

- 1 Turn off the UNI Sustainable.
- 2 Place the UNI Sustainable face down on a soft surface.
- 3 Use a T10 Torx screwdriver to loosen each of the four screws by turning them counterclockwise.
- 4 Remove the top cover after carefully unplugging the buzzer connector.
- 5 Peel a filter from the sheet and center it over the sensor. Gently press down.
- 6 Plug in the buzzer connector and reinstall the top cover.
- 7 Install the screws in back cover. Be careful to not overtighten the screws.

4.3 REPLACE THE SENSOR

The UNI Sustainable models are designed so that you can easily change the sensor.

- 1 Turn off the unit.
- 2 Place the UNI Sustainable face down on a soft surface.
- 3 Use a T10 Torx screwdriver to loosen each of the four screws by turning them counterclockwise.
- 4 Remove the top cover after carefully unplugging the buzzer connector.
- 5 Replace the old sensor with a new one. Make sure the pins are not bent or corroded . Align the pins to the corresponding holes and push the sensor straight in . The sensor should fit flush against the printed circuit board.
- 6 Plug in the buzzer connector and reinstall the top cover.
- 7 Install the screws in back cover. Be careful to not overtighten the screws.

Warning

Sensors are not interchangeable. Use only WatchGas sensors, and use only the sensor type specified for your UNI Sustainable monitor. Use of non-WatchGas components will void the warranty and can compromise the safe performance of this product.

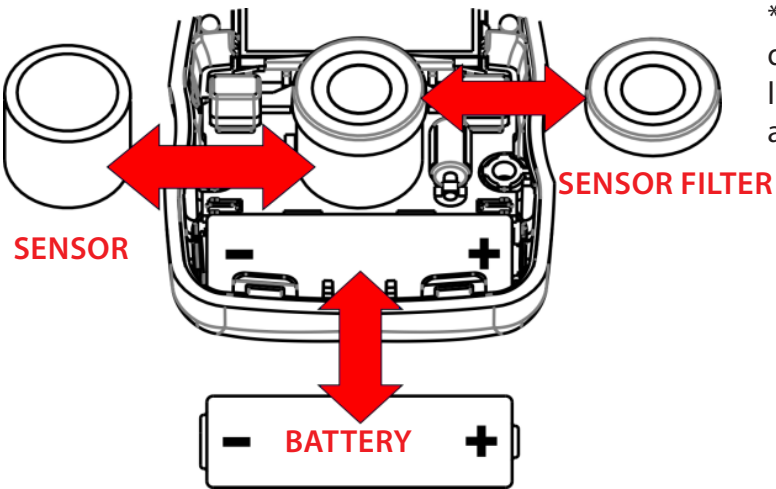
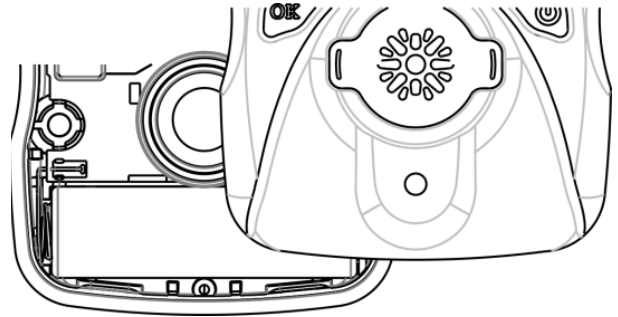
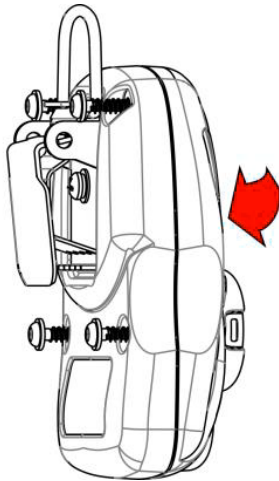
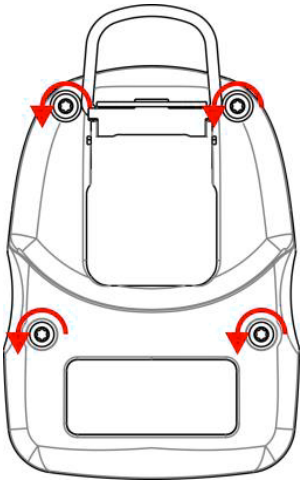

*Filter need to be replaced when it becomes discolored, clogged with particles or draws in liquid, otherwise it will contaminate sensor and void warranty.

Caution

Change battery only in area known to be non-hazardous.
Use only WatchGas battery.

5. Alarm signal summary

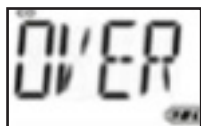

Buzzer: 3 beeps per second
LED: 3 flashes per second
Vibration: 1 per second
"OVER" and "500" 1 flash per second





HIGH ALARM: Buzzer: 3 beeps per second, LED: 3 flashes per second,
Vibration: 1 per second. "HIGH" 2 flashes per second.



LOW ALARM: Buzzer: 2 beeps per second, LED: 2 flashes per second
Vibration: 1 per second. "LOW" 2 flashes per second.

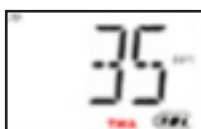

STEL ALARM: Buzzer: 1 beep per second, LED: 1 flash per second,
Vibration: 1 per second. "STEL" 2 flashes per second



TWA ALARM: Buzzer 1 beep per second, LED 1 flash per second,
Vibration: 1 per second. "TWA" 2 flashes per second



NEGATIVE DRIFT ALARM: Buzzer: 1 beep per second, LED: 1 flash per second,
Vibration: 1 per second



BUMP OVER DUE ALARM:
Buzzer: 1 beep per minute, LED: 1 flash per minute, Vibration: 1 per min

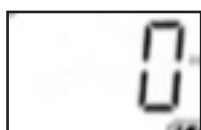



CAL OVER DUE ALARM:

Buzzer: 1 beep per minute, LED: 1 flash per minute, Vibration: 1 per minute

EMPTY BATTERY ALARM: Buzzer: 1 beep per minute, LED: 1 flash per minute, Vibration: 1 per minute and Battery icon: 1 flash per minute

SENSOR ERROR: Buzzer 1 beep per second, LED 1 flash per second,

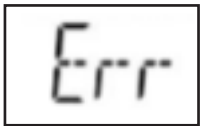
"SEN Err" 1 flash per second

BATTERY LOW ALARM: Buzzer: 1 beep per second, LED: 1 flash per second,

"bAT LoW": 1 flash per second



6. Trouble shooting

Problem	Possible reason	Solution
Can not turn on unit	Battery not installed	Install battery
	Depleted or defective battery	Replace battery
Reading abnormally low	Calibration Adapter is attached.	Remove Calibration Adapter
	Incorrect calibration.	Calibrate the UNI Sustainable
Buzzer, LED, or vibration alarm inoperative	Bad buzzer, LEDs, or vibration alarm.	Call authorized service center
	Blocked alarm port	Unblock alarm port

7. Specifications

DETECTOR SPECIFICATIONS

Size	88 (W)x 62 (H) x 33 (D) mm (3.46 x 2.44 x 1.3 in)
Weight	125 g (4.4 oz)
Sensor technology	26 electrochemical sensor options
Temperature	-20°C to 50°C (-4 to 122°F)
Humidity	5% ~ 95% RH (Non-condensing)
Alarm type	High alarm, Low alarm, STEL alarm, TWA alarm, adjustable. Over range alarm, battery low alarm
Alarm signal	Acoustic: 95dB @ 30cm Visual: 6 bright red LEDs Vibration alarm
Display	LCD Display
Calibration	2-point calibration, zero and span. Power-on zero calibration with user confirmation.
Event log	Up to 50 alarm events
Battery	Replaceable AA Lithium battery for 3 years of operation
Measurement	Diffusion
Housing	Polycarbonate and rubber
Response time T ⁹⁰	15 sec (CO/H ₂ S/O ₂) Others gases vary (technical note 4: Sensor Technical Data Summaries)
IP-Rating	IP67
EMI/RFI	Compliant with EMC 2014/30/EU
Safety certifications	UL/cUL: Class I, Div 1, Group A, B, C, D Class II, Div 1, Group E, F, G Class III, Div 1 T4, -20° C ≤ Tamb ≤ +50° C ATEX: II 1 G Ex ia IIC T4 Ga IECEX: Ex ia IIC T4 Ga CE: Conformité Européenne
Sensor Life	CO/H ₂ S: 5 years Other sensors: 1 to 2 years as per warranty
Warranty	2 years for UNI Sustainable with O ₂ , CO, SO ₂ , HCN, NO, NO ₂ or PH ₃ sensor 1 year for UNI Sustainable with other sensors

SENSOR SPECIFICATIONS

Model	Detectable Gas Ranges		Resolution		Article Number
	ppm	mg/m ³	ppm	mg/m ³	
CO Carbon Monoxide	0 - 500 ppm	915 mg/m ³	1 ppm	2 mg/m ³	M001-0002-W00
	0 - 1000 ppm	1829 mg/m ³	1 ppm	2 mg/m ³	M001-0023-W00
	0 - 2000 ppm	3658 mg/m ³	1 ppm	2 mg/m ³	M001-0026-W00
H₂S Hydrogen Sulfide	0 - 50 ppm	71	0.1 ppm	0.1 mg/m ³	M001-0003-W00
	0 - 100 ppm	142	0.1 ppm	0.1 mg/m ³	M001-0054-W00
	0 - 200 ppm	284	0.1 ppm	0.1 mg/m ³	M001-0057-W00
	0 - 1000 ppm	1418	1 ppm	1 mg/m ³	M001-0060-W00
O₂ Oxygen	0 - 25 %vol		0.1 %vol		M001-0032-W00
	0 - 30 %vol		0.1 %vol		M001-0001-W00
SO₂ Sulfur Dioxide	0 - 50 ppm	53 mg/m ³	0.1 ppm	0.3 mg/m ³	M001-0007-W00
	0-100 ppm	266 mg/m ³	0.1 ppm	0.3 mg/m ³	M001-0091-W00
Cl₂ Chlorine	0 - 50 ppm	147 mg/m ³	0.1 ppm	0.3 mg/m ³	M001-0004-W00
NO Nitric Oxide	0 - 250 ppm	312 mg/m ³	1 ppm	1 mg/m ³	M001-0015-W00
NO₂ Nitrogen Dioxide	0 - 20 ppm	38 mg/m ³	0.1 ppm	0.2 mg/m ³	M001-0011-W00
H₂ Hydrogen	0 - 1000 ppm	83 mg/m ³	1 ppm	0.1 mg/m ³	M001-0018-W00
	0 - 2000 ppm	166 mg/m ³	1 ppm	0.1 mg/m ³	M001-0019-W00
PH₃ Phosphine	0 - 20 ppm	28 mg/m ³	0.01 ppm	0.01 mg/m ³	M001-0016-W00
ETO Ethylene Oxide	0 - 100 ppm	183 mg/m ³	0.1 ppm	0.2 mg/m ³	M001-0012-W00
	0 - 200 ppm	367 mg/m ³	0.1 ppm	0.2 mg/m ³	M001-0069-W00
NH₃ Ammonia	0 - 100 ppm	71 mg/m ³	1 ppm	1 mg/m ³	M001-0006-W00
	0 - 500 ppm	353 mg/m ³	1 ppm	1 mg/m ³	M001-0090-W00
ClO₂ Chlorine Dioxide	0 - 1 ppm	3 mg/m ³	0.01 ppm	0.03 mg/m ³	M001-0072-W00
O₃ Ozone	0 - 5 ppm	10 mg/m ³	0.01 ppm	0.02 mg/m ³	M001-0009-W00
HF Hydrogen Fluoride	0 - 20 ppm	17 mg/m ³	0.1 ppm	0.1 mg/m ³	M001-0014-W00
HCl Hydrogen Chloride	0 - 15 ppm	23 mg/m ³	0.1 ppm	0.2 mg/m ³	M001-0008-W00
HCN Hydrogen Cyanide	0 - 100 ppm	112 mg/m ³	1 ppm	1 mg/m ³	M001-0005-W00
CH₃SH Methyl Mercaptan	0 - 10 ppm	20 mg/m ³	0.1 ppm	0.2 mg/m ³	M001-0077-W00
THT Tetrahydrothiophene	0 - 50 ppm	147 mg/m ³	1 ppm	0.4 mg/m ³	M001-0085-W00
C₂H₄O Acetaldehyde	0 - 20 ppm	37 mg/m ³	0.1 ppm	0.2 mg/m ³	M001-0080-W00

8. Limited Warranty

WATCHGAS warrants this product to be free of defects in workmanship and materials under normal use and service for two years from the date of purchase from the manufacturer or from the product's authorized reseller.

The manufacturer is not liable (under this warranty) if its testing and examination disclose that the alleged defect in the product does not exist or was caused by the purchaser's (or any third party's) misuse, neglect, or improper installation, testing, or calibrations. Any unauthorized attempt to repair or modify the product, or any other cause of damage beyond the range of the intended use, including damage by fire, lightening, water damage or other hazard, voids liability of the manufacturer.

In the event that a product should fail to perform up to manufacturer specifications during the applicable warranty period, please contact the product's authorized reseller or WATCHGAS service center at +31 (0)85 01 87 709 for repair/return information.



WatchGas B.V.
Sextantstraat 61
2908 ZZ Capelle aan den IJssel
+31 (0)85 01 87 709
The Netherlands
info@watchgas.nl - www.watchgas.nl

All rights reserved. No part of this publication may be reproduced, distributed, or transmitted in any form or by any means, including photocopying, recording, or other electronic or mechanical methods, without the prior written permission of the publisher, except in the case of brief quotations embodied in critical reviews and certain other noncommercial uses permitted by copyright law. For permission requests, contact WatchGas B.V.

V.1.0