

CENTER[®] 374

Data Logger THERMOMETER



Instruction Manual

SE-374

CONTENTS

TITLE	PAGE
1. General Description	1
2. Safety Information	1
3. Feature	1
4. Specifications	2
5. Symbol Definition and Button Location	2
6. Operation Instructions	4
6.1 Power ON/OFF & Backlight Operation	4
6.2 REC button	4
6.3 T1-T2 button	4
6.4 MAX/MIN mode	4
6.5 Data-Hold mode	5
6.6 Selecting temperature units	5
6.7 Connecting to a computer	5
6.8 External DC 9V power supply jack	5
6.9 Using the offset to compensate for probe errors	5
7. Data Logger	6
8. Setting the Time	7
9. Power Preparation	7
10. Testlink SE-374 Software	8
11. Maintenance	16

1. GENERAL DESCRIPTION

Thank you for choosing our Data Logger thermometer. To ensure the safety and the best performance of this instrument, we recommend you to read and follow the manual carefully before any operation.

Measurement settings and results are shown on the backlit LCD panel.

Data can be stored in the meter or directly saved on a computer through PC interface. Recorded data can be further processed on a computer.

2. SAFETY INFORMATION

Read the following safety information carefully before attempting to operate or service the meter. Use the meter only as specified in this manual; otherwise the protections provided by the meter may be impaired.

ENVIRONMENT CONDITIONS

- Altitude up to 2000 meters
- Relatively humidity: 90% max
- Operation ambient temperature: -10 to 50°C

MAINTENANCE & CLEARING

- Repairs or servicing not covered in this manual should only be performed by qualified technician.
- Periodically wipe the case with a dry cloth. Do not use abrasives or solvents on this instrument.

SAFETY SYMBOLS

 Comply with EMC

When servicing, use only specified replacement parts.

3. FEATURE

- Four sets of temperature reading display
- 16,000 Records Data Logger
- PC Interface
- With Windows software
- Auto power off for battery saving

4. SPECIFICATIONS

Measurement range :	- 200 to +1372°C (- 328 to +2501°F)
Resolution :	0.1°C/°F < 1000° , 1°C/°F ≥ 1000°
Accuracy :	±(0.1% of reading+0.7°C) ±(0.1% of reading+1.4°F)
Temperature coefficient :	0.01% of reading + 0.05°C per °C (<18°C or >28°C)
Sample rate :	1 times per second
Battery type :	9V Battery
Battery lifetime :	Approx. 80 hours (alkaline battery)
Ac adapter :	9 VDC (8-10VDC Max)
Operation temperature :	-10 to 50°C (14 to 122°F)
Operation humidity :	10 to 90%RH
Storage temperature :	-40 to 60°C (-40 to 140°F)
Storage humidity :	10 to 75%RH
Dimensions :	197mm(L) × 65mm(W) × 36mm(H)
Weight :	Approx. 285g
Standard Accessories :	Instruction manual, 9V Battery, windows software, carrying case, USB cable
Optional Accessories :	AC adapter

Accuracy is specified for ambient temperatures between 18°C (64°F) and 28°C (82°F). The above specifications do not include thermocouple error.

5. SYMBOL DEFINITION & BUTTON LOCATION

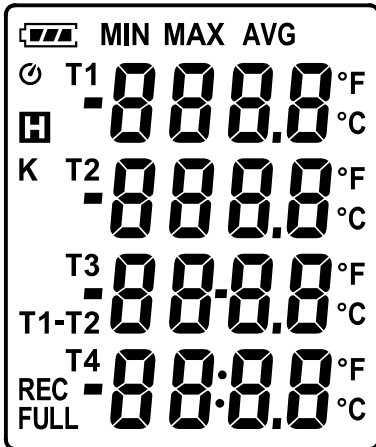

	: Battery capacity indicator
MIN	: Minimum indicator
MAX	: Maximum indicator
AVG	: Average indicator
	: This indicates Auto Power Off is enabled
REC	: Recording data logger indicator
FULL	: Memory full indicator
K	: Thermocouple type
1888	: Temperature reading
°C °F	: Temperature measurement units
	: Data hold indication

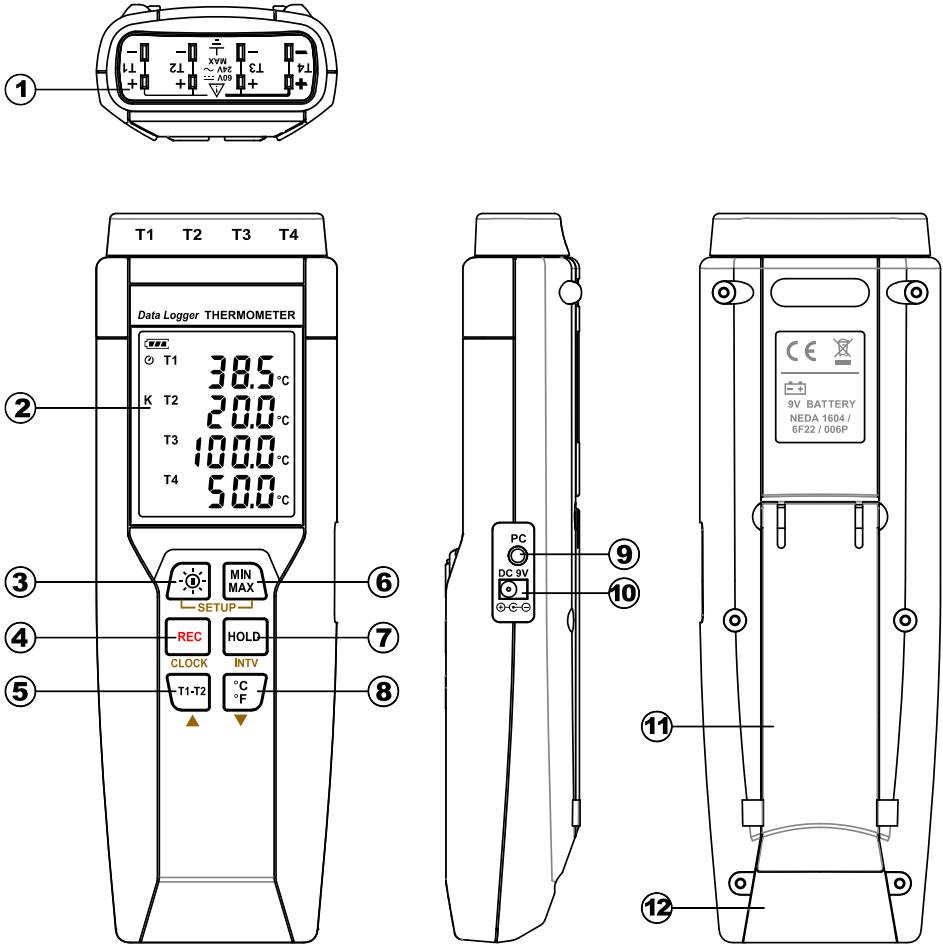



- | | |
|--------------------------------------|------------------------------------|
| ① Thermocouple input | ⑦ DATA HOLD button |
| ② Display screen | ⑧ °C , °F button |
| ③ Power ON/OFF and Back light button | ⑨ PC Interface |
| ④ REC button | ⑩ External DC 9V power supply jack |
| ⑤ T1-T2 button | ⑪ Tilt stand |
| ⑥ MAX MIN button | ⑫ Battery Compartment |

6. OPERATION INSTRUCTIONS



6.1 Power ON/OFF & Backlight Operation:

6.1.1 Power on/off:

Press the  button to turn on the unit. To turn the unit off, press and hold  button down until the screen shows "OFF 3, 2, 1," then the LCD screen goes off.

Note: When the unit is on, the LCD will show the following initial information before entering the main function: **Current date/time → Available memory → Entering main function**

6.1.2 LCD backlight on/off:

Press  to turn on the LCD backlight, making it easier to read in dark environment. Press  again to turn off backlight. The backlight will turn itself off automatically after 30 seconds to save battery power.





6.1.3 Auto power off:

To save battery life, by default, every time the unit is powered on, it is under auto power off mode. The unit will power itself off after 30 minutes if no key operation.

Auto power off will be automatically disabled under the following 2 circumstances:

- When connecting to PC.
- When data logger function is on process.

6.1.4 Disabled auto power off:

- (1) Turn off the unit.
- (2) Press and hold  button, and keep holding  button.
- (3) Press  to turn on the unit.
- (4) The LCD shows the initial information and then enters main function.
- (5) Release  button.
- (6) Make sure the auto power off  symbol disappears from display screen.

6.2 REC button:

Press  button to start recording data. The **REC** symbol will display on the screen. To stop recording, press  button again.

6.3 T1-T2 button:

Toggle showing the T3 or T1-T2.
(see Fig.1)

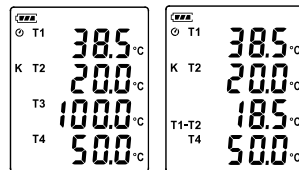

Fig.1





6.4 MAX/MIN mode (only for channel T1):

Under this mode, the unit simultaneously monitors and stores the maximum, minimum and average value in the memory. The unit will keep updating/refreshing the data.



To start:

- (1) Press  button. **MAX** symbol lights up on LCD, the reading shows the maximum data.
- (2) Press  button again to show minimum data; the **MIN** symbol lights up on LCD.
- (3) Press  button again to show average data; the **AVG** symbol lights up on LCD.

- (4) Press  button again, the **MAX** and **MIN** symbol blinks together. The reading shows present T1 temperature.
- (5) Press  button again, **MAX** symbol lights up, and the mode returns to (1).



To exit:

Press and hold  button for 2 seconds to stop storing maximum and minimum and average data.

Note: When the unit is in the MAX/MIN mode,  ,  and  buttons are disabled.

6.5 Data-Hold mode

Press  button to freeze the data shows on the LCD screen. Press again to exit Data-Hold mode.

Note: When the unit is in the Data-Hold mode, the  ,  , and  buttons are disabled.

6.6 Selecting temperature units:

By default, each time the unit is powered on, the scale is set to the Celsius (°C). Press the  button to switch between Celsius (°C) and Fahrenheit (°F).

6.7 Connecting to a computer:

The PC jack signal output is a 9600 bps N 8 1 serial interface. Use the USB cable (standard accessory) to connect with a computer.

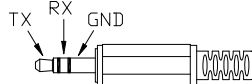







6.8 External DC 9V power supply jack:

Connect the AC adapter (optional accessory) to use external power.

6.9 Using the offset to compensate for probe errors:

You can adjust the readings of thermometer to compensate for the errors against a specific thermocouple.

- (1) Plug the thermocouple into the input T1 terminal.
- (2) Turn off the unit.
- (3) Enter offset setting mode by pressing and holding  button and then press  power button to turn on the unit.(see Fig.2)
- (4) Place the thermocouple in a known stable temperature environment (such as an ice bath or a dry well calibrator).
- (5) Allow the readings to stabilize.
- (6) Press  () or  () to adjust value.
- (7)When finish, press  button to exit **offset setting** mode.

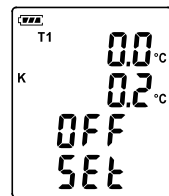



Fig.2

Note: To abort during the process, press  power button to exit **offset setting** mode.

Note: The offset value will affect every channel.

※How to display offset value:

Press  button for more than 1 second to display offset value. (see Fig.3)

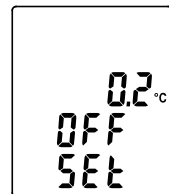











Fig.3

7. DATA LOGGER

This section will explain how to store data (data logger) in memory and how to recall data from memory.

7.1 Setting interval time for data storing:

- (1) Turn off the unit.
- (2) Enter SETUP mode by pressing and holding  button and then press  power button to turn on the unit. "SET" blinks on the LCD screen.(see Fig.4)
- (3) Press INTV () button to set interval time.(see Fig.5)
- (4) Press  () or  () to adjust the interval minute, press INTV () button again to adjust second.
- (5) When finished, press INTV () button to exit SETUP mode.

Note: To abort during the process, press power button to exit SETUP mode.

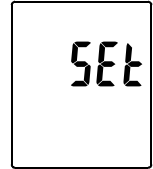





Fig.4



Fig.5

7.2 Start data logger (storing data in the memory):





- (1) Press  button to start data logger (storing the measured values in built-in memory).
- (2) REC symbol lights up on LCD screen.
- (3) Press REC button again to stop recording.

Note: During recording period, most of the buttons are disabled, such as the , , etc. All other settings must be made before starting the data logger function.

Note: When the memory is full (16000 recorders), FULL symbol will blink on the LCD screen. The data logger stops.

Note: When battery power low ( symbol lights up on the screen), data logger cannot be started. If during data logger, the battery starts running low, data logger will stop automatically.







7.3 Clearing Data:

- (1) Turn off the unit.
- (2) Press and hold  button and then press  power button to turn on the unit.
- (3) Keep holding  button, then LCD will show "CLr" and "SURE 5, 4...1, 0" until clean the memory. (To abort, release  button before "SURE 0".)

8. SETTING DATE AND TIME

The unit incorporates a clock so that the data logger function can also record the data and time along with the measurement value in the memory.

8.1 Setting date and time:

- (1) Turn off the unit.
- (2) Enter SETUP mode by pressing and holding  button and then press  power button to turn on the unit. "SEt" blinks on the LCD screen. (see Fig.6)
- (3) Press CLOCK  button to set clock.
- (4) Press  ($T1-T2$) or  ($^{\circ}C$ / $^{\circ}F$) to adjust year, press CLOCK  button to adjust next value (month →date→hour→minute). (see Fig.7)
- (5) When finish, press CLOCK  button to exit SETUP mode.

Note: To abort during the process, press power button to exit SETUP mode.

Note: An internal backup battery supplies power for the clock.

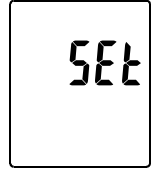

Fig.6

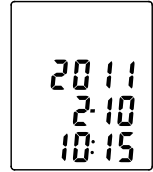
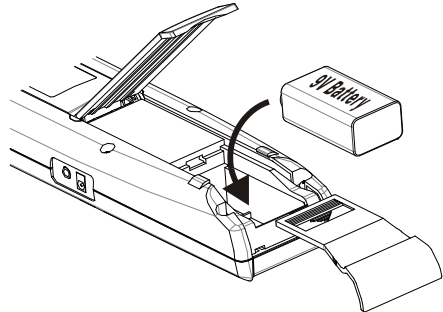

Fig.7

9. POWER PREPARATION

9.1 Battery Loading:

Remove the battery cover on the back and insert one 9V battery.



9.2 Battery capacity indicator:

When operating the unit on batteries, periodically check this indicator to determine the remaining battery capacity.

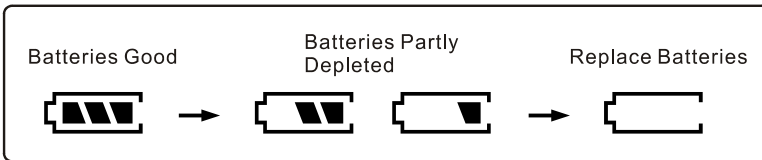

9.3 AC Adapter Connection:

When the AC adapter is used, insert the plugs of the adapter into the DC9V connector on the side panel.

Note: When the AC adapter is connected while battery is inserted, the unit will be powered from the adapter (the AC adapter has priority).

10. TESTLINK SE-374 SOFTWARE

10.1 The SE-374 package contains:

- 80mm CD
- Custom designed USB cable for SE374

10.2 System Required:

Windows NT 4.0/ NT2000/ XP/ VISTA/ Windows 7

10.3 Minimum Hardware Required:

- PC or NoteBook with Pentium 800MHz or higher, 512 MB RAM
- At least 50 MB hard disk space available to install SE374
- Recommended screen resolution 1024X768 or above

10.4 Install SE-374 and USB-120 connector driver:

- (1) We recommend close all other application before installing SE374.
- (2) Insert setup CD disk to CD disk drive to display install screen. You may also run mainsetup.exe in the directory of the CD.
- (3) Click Install to begin installation.
- (4)..It will install USB-120 connector driver first:
- (5) While installing, it will show this window below, just click “**next**” to continue.(see Fig.5)
- (6) Select “Launch the CP210x VCP Driver Installer” option, then click Finish. (see Fig.6)

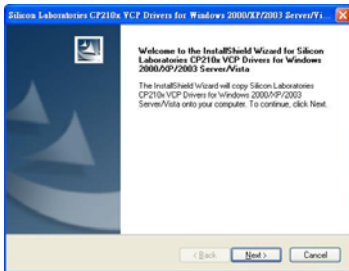

Fig.8

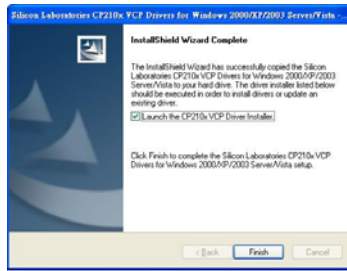
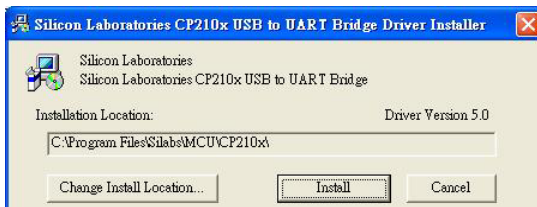

Fig.9

- (7) Click Install.



- (8) After finish installing USB-120 connector driver, it will install SE374 software automatically. It will copy SE374.exe (executable file) and help file to your hard disk (default is c:\program files\SE374)
- (9) After finish installation, plug USB-120 connector to PC usb port, execute "start"→ "My Computer", then choose "View System Information" on the left top of the window, the window below will show up.(see Fig.7)
- (10) Choose "Hardware" option and click "Device Manager" button, click "+" symbol on the left side of Ports(COM &LPT), if the device "CP2101 USB to UART Bridge Controller(COMx)" is in the list, the connector is ready to work.(see Fig.8)

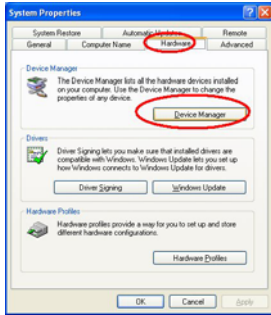

Fig.10

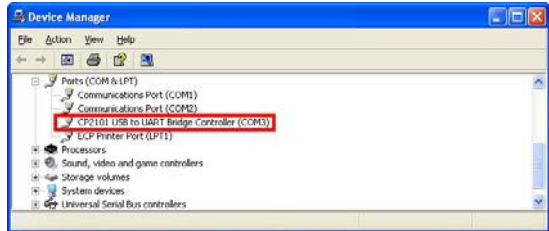



Fig.11

10.5 Tutorial - Quick Start to Use TestLink SE374:

- (1) Recording real time data in waveform.
- (2) Power on the 4 Channel Thermometer first and connect it to a PC RS-232 serial port with the cable(USB-120),
- (3) Start SE374 program.
- (4) If the connection is successful the panel will display the same value as the 4 Channel Thermometer. If fail to connect the meter with PC, it will display "No Connection" on the panel window in TestLink SE374.
- (5) Select sampling rate from Real-Time Graph window.



Note: If PC speed is slow , select sampling rate above 1 second. And if it is going to sample a large amount data(more than 5000), at least 512 mega bytes ram is recommended to keep PC running in good performance working well.

- (5) When the connection is successful, click “Real Time | run” or  from main menu to start recording real time data and there will be a waveform on the Real Time Graph Window.
- (6) Click “Real Time | Stop” or  to stop recording.

10.6 How to save the recorded real time data to a file?

- (1) Click the graph window you want to save and the graph window will become active, then choose File | Save from main menu or click from the tool bar .

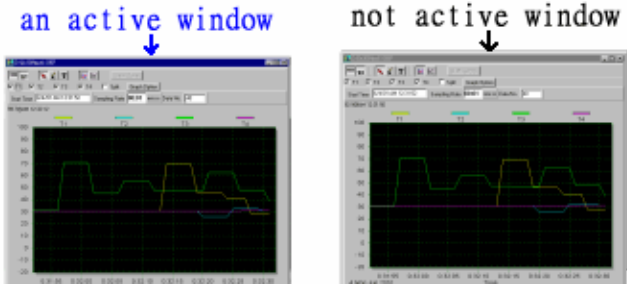

- (2) There will be a save dialog window for you to choose the file name and file type to save. There are three types of file name you can choose, binary file(*.ghf), text file(*.txt) and EXCEL format file(*.csv). The *.ghf file use much fewer disk space to save the data than the other two file format, but it can only be used in TestLink SE374. Text file can be opened by TestLink SE374 and any other word processor program like word, notepad etc. EXCEL format file can be opened by TestLink SE374 and Microsoft EXCEL.

Note: If decimal separator is comma in your country, this file format will be disabled, because .CSV file also use comma to be data separator. For example 78,6 will become 78 and 6 in EXCEL)

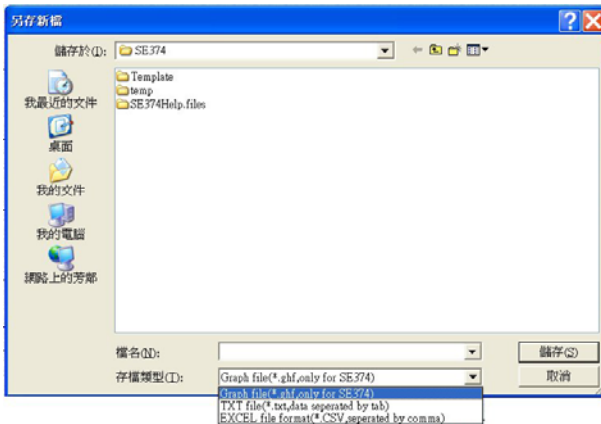

10.7 How to load the recorded data from the memory of 4 Channel Thermometer and save it to a file?

- (1) Power on the 4 Channel Thermometer.
- (2) Press the REC button of the meter to start recording data.
- (3) After a while, press REC button again to stop recording data.
- (4) Connect the Meter to PC
- (5) Start SE374 program.
- (6) Choose Data Logger from main menu or click  from tool bar.

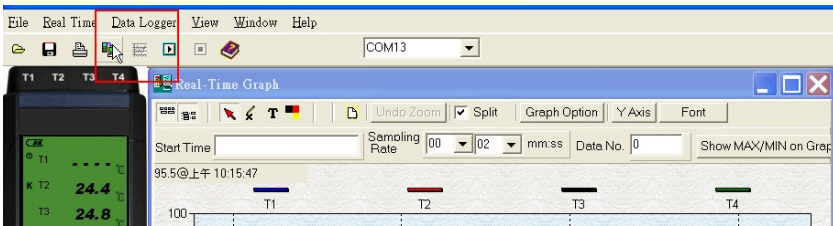

- (7) In reference to Data Logger , see DataLogger

10.8 Main Menu:

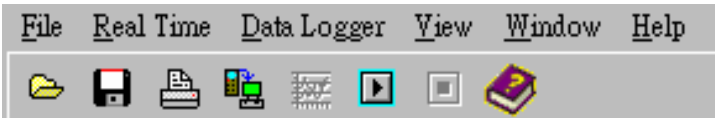

File | Open - Retrieve files from the disk.



Save - Save the active window (when the caption bar is highlighted) data to the disk.



Print - Print the data of the active window (graph or list).

Printer Setup - Select printer.

File | Exit: Terminates TestLink program.

View | Control Panel:

By opening the Panel Window, the user can control meter via the button in this window.

View | Real-Time Graph:

Open Real-Time Graph display to graph the present data.



Real Time Data | Run - Start collecting real time data.



Stop - Stop collecting real time data.



DataLogger:

By opening the DataLogger Window, the user can load recorded data of meter to PC in this window.



Output To Graph - Graphing tabular data.

10.8 DataLogger:

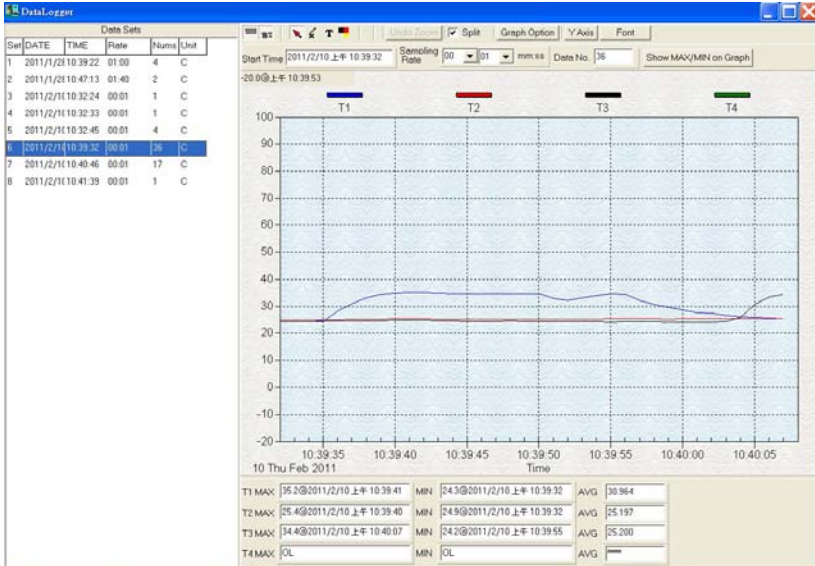

When you have 4 Channel Thermometer Data Logger meter connected to PC and select "DataLogger" from main menu or click Datalogger icon from tool bar to load recorded data from the meter and there will be a progress indicator to show the loading progress. If error occurs, just click "DataLogger" again.

After the data was loaded, the left hand side will show how many data sets were loaded and detail information for each data set (start data, start time, recording rate and record numbers).

for examples:

Data Sets					
Set	DATE	TIME	Rate	Nums	Unit
1	2011/1/28	10:39:22	01:00	4	C
2	2011/1/28	10:47:13	01:40	2	C
3	2011/2/10	10:32:24	00:01	1	C
4	2011/2/10	10:32:33	00:01	1	C
5	2011/2/10	10:32:45	00:01	4	C
6	2011/2/10	10:39:32	00:01	36	C
7	2011/2/10	10:40:46	00:01	17	C
8	2011/2/10	10:41:39	00:01	1	C

It will transfer first data set to graph and tabular on the right hand side every time after you load recorded data from the meter and you can click at any data set to change the set for graph.

On the right hand side is the waveform graph and statistic of the data set you choose. In reference to graph, see Graph.

Graph:

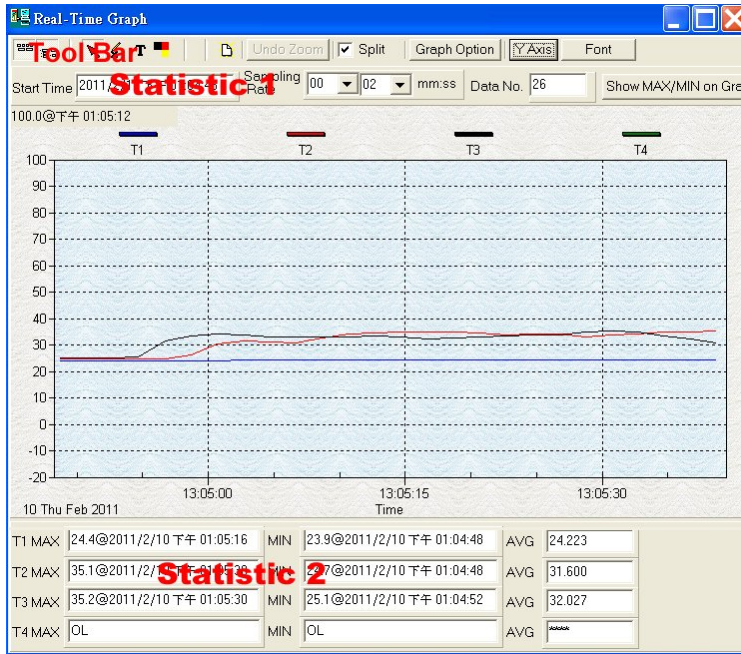

Tool Bar:



- Display or hide Statistic1.



- Display or hide Statistic2.



- Normal cursor.



- When selected, the mouse cursor will become a cross sign when moving to the graph, click on the graph to mark a cross sign on the graph. This is available only when "Split" option is unchecked. And all the mark you make will exist with T1.



-When selected, the mouse cursor will become a "I" sign when moving to the graph, click on the graph to annotate. This is available only when "Split" option is unchecked. And all the text you make will exist with T1.

Split - Separate the four channel.

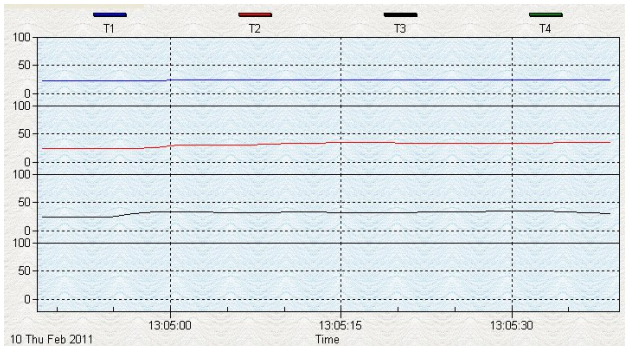

Split - Combine the four channel.

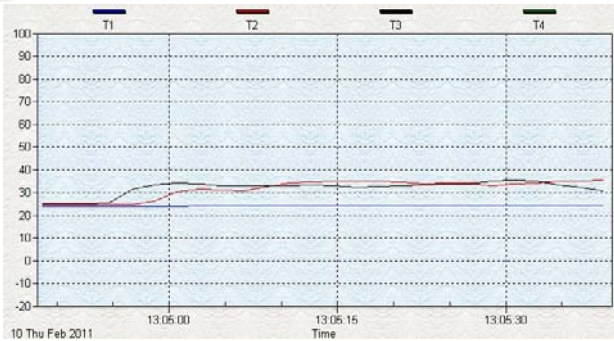

Graph Option -Graph Customization

Y Axis -Change the Y axis extension

The screenshot shows a dialog box titled "Y Axis Maximum And Minimum Scale Setup". It contains four groups of input fields for channels T1, T2, T3, and T4. Each group has a "MIN" and "MAX" field. For T1, MIN is 20 and MAX is 100. For T2, T3, and T4, MIN is -20 and MAX is 100. At the bottom, there is a "Save this set" checkbox, an "OK" button with a green checkmark, and a "Cancel" button with a red X.

Note: When the Split is unchecked, graph will use T1 as the Y axis display range.

Undo Zoom -To Undo the Zoom

You can Zoom this graph by using mouse:

To Zoom:

- (1) Press the left mouse button and drag the cursor to select the new extents.
- (2) Release the mouse button.

You can choose channel number showing in the graph.

- a. Click "Graph Option" to call Customization dialog.
- b. Select Subsets tab.
- c. Select a single channel or multiselect (hold Ctrl key, use mouse to choose) channels.

10.9 Frequently Asked Question:

(1) I had connected 4 Channel Thermometer to PC serial port and turned meter power on, but it still show "NO CONNECTION"?

Answer: It could be that all com port are occupied by other application, close all other application. If it still don't work. Restart your computer and run TestLink SE374 again. When program start, it will search automatically all com port to check connected 4 Channel Thermometer. You can check the connection status from main window like the figure below, Thermometer is connected to Com2. You can manually change to another COM port when you find out that program can not find the correct COM port which 4 Channel Thermometer is connected to.

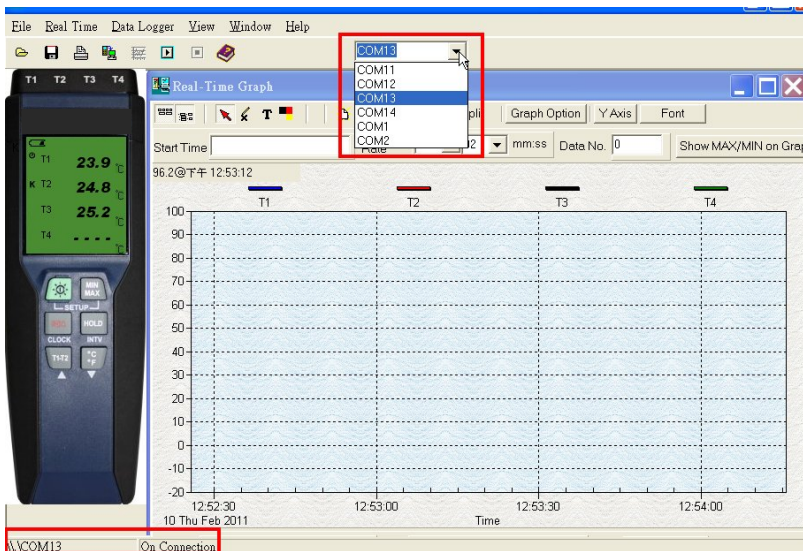

(2) How can I save the graph to a file which can be used in EXCEL?

Answer: When you save a graph to a file, the default file format is "*.ghf" and you can select *.csv to save files. CSV is an EXCEL file format. You can open it in EXCEL.

Note: *If decimal separator is comma in your country, this file format will be disabled, because .CSV file also use comma to be data separator. for example 78,6 will become 78 and 6 in EXCEL*

(3) How to uninstall TestLink SE374 ?

Answer: Uninstall TestLink SE374 by launching the Add/Remove Programs applet out of the Control Panel, highlighting the SE374, and clicking on the Add/Remove... push button, then it will remove the SE374 folder and files from your computer.

(4) Why loading data fail?

Answer: This might cause by the slow respond from some of the notebook PC system.

(5) How to zoom the graph?

Answer: Press the left mouse button and drag the cursor to select the new extents, then release the mouse button.

(6) When I setup the real time sampling with a fast rate(eg. 1 sec), Some of the sampling data might be lost.

Answer: This might be caused by slow response time of the PC interface. For better result, the user may close the panel window.

11. Maintenance

In order to ensure the accuracy of the thermometer for a longer period of time you should calibrate it once a year.

Clean the device and the window of the display with a clean, lint-free, antistatic and dry cleaning cloth.

⚠ *Do not use cleaning agents that contain carbon or benzenes, alcohol or anything similar to clean the product since these substances damage the surface of the measuring instrument. Moreover, these fumes are hazardous to health and explosive. Do not use tools with sharp edges, screwdrivers, metal brushes or anything similar to clean the device.*

CENTER[®] CENTER TECHNOLOGY CORP.

4F, NO.415, Jung-Jeng Rd., Shu-Lin Dist., New Taipei City 238, Taiwan

TEL: 886-2-26763926

E-Mail : center@centertek.com

FAX: 886-2-26763925

[http : // www.centertek.com](http://www.centertek.com)

GCA000374-02000
