



KERN & Sohn GmbH

Ziegelei 1
D-72336 Balingen
E-Mail: info@kern-sohn.com

Tel: +49-[0]7433-9933-0
Fax: +49-[0]7433-9933-149
Internet: www.kern-sohn.com

Service manual

Display Unit

KERN KFB / KFN-TAM

Version 1.0
05/2018
GB

Importør:
Impex Produkter AS
Gamle Drammensvei 107
1363 Høvik
www.impex.no
info@impex.no
Tel.: 22 32 77 20





KERN KFB/KFN-TM

Version 1.0 05/2018

Service manual

Content

1	Basic Information	3	-
2	Introduction	4	-
3	INSTALLATION	4	-
3.1	Installation.....	4	-
4	Appliance overview	6	-
4.1	KFB-TM: Synthetic finish.....	6	-
4.2	KFN-TM: Stainless steel finish.....	7	-
4.3	Keyboard overview.....	8	-
4.3.1	Numerical input via the navigation buttons.....	9	-
4.3.2	Overview of display.....	9	-
5	Menu	10	-
5.1	Overview non verifiable weighing systems (contacts of circuit board [K1] not short-circuited).....	11	-
5.2	Overview verified weighing systems (contacts of circuit board [K1] short-circuited by means of jumper).....	14	-
6	Service, maintenance, disposal	18	-
6.1	Clean	18	-
6.2	Service, maintenance.....	18	-
6.3	Disposal.....	18	-
6.4	Error messages.....	18	-
7	Data output RS 232C	20	-
7.1	Technical data.....	20	-
7.2	Printer mode.....	20	-
7.3	Output log (continuous output)	21	-
7.4	Remote control instructions.....	22	-
8	Instant help	22	-
9	Installing display unit / weighing bridge	23	-
9.1	Technical data.....	23	-
9.2	Weighing system design	23	-
9.3	How to connect the platform	24	-
9.4	Configure display unit.....	26	-
9.4.1	Verified weighing systems (contacts of circuit board [K1] short-circuited by means of jumper)	26	-
9.4.2	Non verifiable weighing systems (contacts of circuit board [K1] not short-circuited).....	31	-

10	MAINTENANCE	- 34 -
10.1	General	- 35 -
10.2	Error Codes	- 35 -
10.3	Check the Load cell	- 36 -
10.4	Check Indicator Voltages.....	- 36 -
10.4.1	AC Power	- 36 -
10.4.2	Adaptor Voltage	- 36 -
10.4.3	PCB Input Voltage.....	- 37 -
10.4.4	Check Battery Voltage and Charging Voltage.....	- 37 -
10.5	Problems and Solutions	- 38 -
11	10. TROUBLE SHOOTING	- 40 -
11.1	No Power	- 40 -
	No Display	- 41 -
	Battery not charging	- 42 -
11.2	Not Weighing.....	- 43 -
11.3	Unstable.....	- 44 -
12	11. CIRCUIT DIAGRAM	- 45 -
13	DRAWING	- 49 -
13.1	Drawing KFB-TM.....	- 49 -
13.2	Parts List	- 50 -
13.3	Drawing KFN-TM.....	- 51 -
13.4	Parts List	- 52 -

1 Basic Information

The device must be repaired only by trained specialist staff or personnel with professional formation (such as a repair-specialist accredited by law concerning verification). The service manual is obligatory for repair work. After repair, original conditions of the device have to be restored. Only original spare parts should be used.

Instructions about conformity-evaluated scales:

Repair must be carried only at 100% compliance with the type approval. A violation of this specification will result in a loss of the type approval! After successful repair the balance will have to be reverified before it can be used again in a statutorily regulated field.

Detailed instructions about conformity-evaluated scales:

Repair must be carried only at 100% compliance with the type approval. A violation of this specification will result in a loss of the type approval!

After successful repair the balance will have to be reverified before it can be used again in a statutorily regulated field.

2 Introduction

This service manual covers the EOA series and is edited for the authorized servicing personnel. Note all rights are reserved. Copying any part of this manual is prohibited without our permission.

In this lineup it is an eco product, Therefore, it is not intended to represent the repair manual in detail, since the construction of the balance is very simple. It is therefore only referring to the list of related to disposal spare parts.

3 INSTALLATION

Precautions



- The weighing indicator is a precision electronic instrument, handle it carefully.
- Do not install the scale in direct sunlight.
- Verify the local voltage and receptacle type are correct for the scale.

- Only use original adaptor, other could cause damage to the scale.
- Pluggable equipment must be installed near an easily accessible socket outlet.
- Avoid unstable power sources. Do not use near large users of electricity such as welding equipment or large motors.
- Avoid sudden temperature changes, vibration, wind and water.
- Avoid heavy RF noise.
- Keep the indicator clean.

3.1 Installation

- Place the Indicator on a table or connect with proper stand.
- Connect the plat form load cell cable in to the indicator load cell connecter. Load cell connecter is locating back side of the indicator.
- Connect the adaptor pin in to the indicator adaptor jack. Adaptor jack is locating, back side of the indicator.
- Adaptor connects into your AC power socket. Pluggable equipment must be installed near an easily accessible socket outlet with a protective ground/ earth contact.
- Turn on the On/Off key. If you want to turn off, press the key again.

- Display will be show the scale capacity and will be starting self checking.
- After self checking, display will be come to normal weighing mode.
- Warm-up time of 15 minutes stabilizes the measured values after switching on.
- Calibrate with exact calibration weights, minimum 1/3 of the scale capacity want to use for calibration. For calibration see details in parameter.

Then you can start your operation

4 Appliance overview

4.1 KFB-TAM: Synthetic finish











1. Status of rechargeable battery
2. Keyboard
3. Weight display
4. Tolerance margin
5. Weighing unit
6. RS-232
7. Input connection load cell cable
8. Guide rail support base / stand
9. End stop support base / stand
10. Mains adapter connection
11. Adjustment switch
12. Adjustment switch

4.2 KFN-TAM: Stainless steel finish



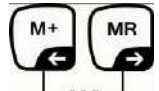

1. Status of rechargeable battery
2. Keyboard
3. Weight display
4. For tolerance mark
5. Weighing unit
6. Input connection load cell cable
7. Mains adapter connection

4.3 Keyboard overview



Key	Function
	<ul style="list-style-type: none"> • Turn on/off
 Navigation button ←	<ul style="list-style-type: none"> • Zeroing • Confirm entry
 Navigation key ↑	<ul style="list-style-type: none"> • Taring • At numeric input increase flashing digit • Scroll forward in menu
 Navigation key →	<ul style="list-style-type: none"> • Display sum total • Digit selection to the right
 Navigation key ←	<ul style="list-style-type: none"> • Add weighing value to summation memory • Digit selection to the left
 C	<ul style="list-style-type: none"> • Calculate weighing data via interface • Delete
 ESC	<ul style="list-style-type: none"> • Change between gross ↔ and net weight • Back to menu/weighing mode
	<ul style="list-style-type: none"> • Call up animal weighing function
	<ul style="list-style-type: none"> • Call up weighing with tolerance range
 MC	<ul style="list-style-type: none"> • Delete total added memory

4.3.1 Numerical input via the navigation buttons

⇒ Press  and current setting will be displayed. The first digit will be flashing and is ready for changing.

⇒ If you do not wish to change the first digit, press  and the second digit will start flashing.

Each time you press , the display will move to the subsequent digit, after the last digit the display will return to the first digit.

⇒ To change the selected (flashing) digit, press  repeatedly until the desired value is displayed. Then press  to access further digits and change them by .

⇒ Complete your entry by .

4.3.2 Overview of display

Display	Significance
	Battery very low
STABLE	Stability display
ZERO	Zero indicator
GROSS	Gross weight
NET	Net weight
AUTO	Automatic add-up enabled
Kg	Weighing unit
M+	Totalisation
LED + / ✓ / -	Indicators for weighing with tolerance range









5 Menu

The application of the display unit as a verified weighing system requires that you short-circuit the two contacts [K1] of the circuit board, using a jumper. To that effect, a menu for verified weighing systems is available. For menu layout see chap. 8.2.



There is no jumper for weighing systems that cannot be verified. To that effect, a menu is available for weighing systems that cannot be verified, Menu layout



see chap. 8.1



Navigation in the menu:

<p>Call up menu</p>	<p>⇒ Switch-on balance and during the selftest press  .</p> <div style="text-align: center; border: 1px solid black; padding: 5px; width: fit-content; margin: 10px auto;">Pn</div> <p>⇒ Press , ,  subsequently, the first menu block „PO CHK“ will be displayed.</p> <div style="text-align: center; border: 1px solid black; padding: 5px; width: fit-content; margin: 10px auto;">POCHK</div>
<p>Select menu block</p>	<p>⇒ With help of , the individual menu items can be selected one after the other.</p>
<p>Select setting</p>	<p>⇒ Confirm selected menu item by pressing . The current setting will be displayed.</p>
<p>Change settings</p>	<p>⇒ To change to the available settings, press the navigations keys as described in chap. 2.1.</p>
<p>Acknowledge setting / exit the menu</p>	<p>⇒ Either save by pressing  or cancel by pressing .</p>
<p>Return to weighing mode</p>	<p>⇒ Press  repeatedly to exit menu.</p>

5.1 Overview non verifiable weighing systems (contacts of circuit board [K1] not short-circuited)

Menu block Main menu	Menu item Submenu	Available settings / explanation		
PO CHK Weighing with tolerance range, see chap. 7.7	nEt H	Upper limit value „Tolerance check weighing“, input see chap. 7.7.1		
	nEt LO	Lower limit value „Tolerance check weighing“, input see chap. 7.7.1		
	PCS H	Upper limit value „Tolerance check counting“, input see chap. 7.7.2		
	PCS L	Lower limit value „Tolerance check counting“, input see chap. 7.7.2		
	BEEP	no	Acoustic signal for weighing with tolerance range switched off	
		ok	Audio sound when load is within tolerance limits	
nG		Audio sound when load is beyond tolerance limits		
P1 REF Zero point settings	A2n0	Automatic zero point correction (Autozero) by changing the display, digits selectable (0.5d, 1d, 2d, 4d)		
	0AUto	Zero setting range Load range where the display after switching-on the balance is set to zero. Selectable 0, 2, 5, 10, 20, 30, 50, 100 %		
	0rAGE	Zero setting range Load range where the display is set to zero by pressing  . Selectable 0, 2, 4, 10, 20*, 50, 100%.		
	0tArE	Automatic taring „on / off“, taring range adjustable in menu item „0Auto“.		
	SPEEd	Not documented		
	Zero	Zero point setting		
P2 COM Interface parameter	MODE	CONT	S0 off	Continuous data output, selectable “send zero” yes / no
		S0 on		
	ST1	One output for stable weighing value		
	STC	Continuous data output of stable weighing values		
	PR1	Output after pressing 		

		PR2	Manual totalizing, see chap. 7.8.  Press  and the weighing value will be added to the summation memory and issued.	
		AUTO*	For automatic add-up see chap. 7.9. This function is used to issue and add individual weighing values automatically to the summation memory on unloading of weighing scale.	
		ASK	For remote control commands, see chap. 10.4	
		wirel	Not documented	
		BAUD	Available Baudrate: 600, 1200, 2400, 4800, 9600*	
	Pr	7E1	7 bits, even parity	
		7o1	7 bits, odd parity	
		8n1*	8 bits, no parity	
	PTYPE	tPUP*	Standard printer setting	
		LP50	Not documented	
	Lab	Lab x	For data output format, see chap.8.2, tab. 1	
	Prt	Prt x		
	LAnG	eng*	Standard settings English	
		chn		
P3 CAL Configuration data see chap. 12.4	COUNT	Display internal resolution		
	DECI	Position of the decimal dot		
	DUAL	Setting balance type, capacity (Max) and readability (d)		
		off	Single-range balance	
			R1 inc	Readability
			R1 cap	Capacity
		on	Dual range balance	
			R1 inc	Readability 1st weighing range
	R1 cap		Capacity 1st weighing range	

					
			R2 inc	Readability 2nd weighing range	
			R2 cap	Capacity 2nd weighing range	
	CAL	noLin	For adjustment, see chap. 6.9.2		
		Liner	For linearization, see chap. 6.10.2		
	GrA	Not documented			
P4 OTH	LOCK	on	Keyboard lock enabled, see chap. 7.11		
		off*	Keyboard lock disabled		
	ANM	on	Animal weighing enabled, see chap. 7.10		
		off*	Animal weighing disabled		
P5 Unt Switch-over weighing unit, see chap. 7.5	kg	on*			
		off			
	g	on			
		off*			
	lb	on			
		off*			
	oz	on			
		off*			
	tJ	on			
		off			
	HJ	on			
		off			
	P6 xcl		Not documented		
	P7 rst				Use  to reset balance settings to factory default.
P8 uwb		Not documented			

Factory settings are marked by *.

5.2 Overview verified weighing systems (contacts of circuit board [K1] short-circuited by means of jumper)

In verified weighing systems the access to „P2 mode and „P4 tAr“ is locked.

KERN KFB-TAM:

To disable the access lock, destroy the seal and actuate the adjustment switch. Position of the adjustment switch see chap. 6.11.



KERN KFN-TAM:

In order to unlock the access, the seal must be destroyed and both contacts of the printed circuit board [K2] must be short-circuited by a jumper, see chap. 6.11.



Attention:

After destruction of the seal the weighing system must be re-verified by an authorised agency and a new verification wire/seal mark fitted before it can be reused for applications subject to verification.

Menu block Main menu	Menu item Submenu	Available settings / explanation		
PO CHK Weighing with tolerance range, see chap. 7.7	nEt H	Upper limit value „Tolerance check weighing“, input see chap. 7.7.1		
	nEt LO	Lower limit value „Tolerance check weighing“, input see chap. 7.7.1		
	PCS H	Upper limit value „Tolerance check counting“, input see chap. 7.7.2		
	PCS L	Lower limit value „Tolerance check counting“, input see chap. 7.7.2		
	BEEP	no	Acoustic signal for weighing with tolerance range switched off	
		ok	Audio sound when load is within tolerance limits	
		ng	Audio sound when load is beyond tolerance limits	
P1 COM Interface parameter	MODE	CONT	S0 off	Continuous data output, selectable “send zero” yes / no
			S0 on	
		ST1	One output for stable weighing value	
		STC	Continuous data output of stable weighing values	

		PR1	Output after pressing 
		PR2	Manual totalizing, see chap. Fehler! Verweisquelle konnte nicht gefunden werden. Press  and the weighing value will be added to the summation memory and issued.
		AUTO	For automatic totalizing see chap. Fehler! Verweisquelle konnte nicht gefunden werden. This function is used to issue and add individual weighing values automatically to the summation memory on unloading of weighing scale.
		ASK	For remote control commands, see chap. 7.4
		wireless	Not documented
	baud	Available Baudrate: 600, 1200, 2400, 4800, 9600	
	Pr	7E1	7 bits, even parity
		7o1	7 bits, odd parity
		8n1	8 bits, no parity
	PtYPE	tPUP	Standard printer setting
		LP50	Not documented
	Lab	Lab x	Details see following table 1
	Prt	Prt x	
Lang	Eng*	Standard setting English	
	Chn		
P2 mode Konfigurations- daten	SiGr	Single-range balance	
		COUNT	Display internal resolution
		DECI	Position of the decimal dot
		Div.	Readability [d] / verification value[s]
		CAP	Balance capacity [Max]

		CAL	noLin	Adjustment, see chap. Fehler! Verweisquelle konnte nicht gefunden werden.	
			LinEr	Linearisation, see chap. Fehler! Verweisquelle konnte nicht gefunden werden.	
		GrA	Not documented		
	dUAL 1	Dual range balance			
		Balance with two weighing ranges and different maximum load and weighing ranges and interval sizes but only one load-supporting pan, whereby each range extends from zero to the respective maximum capacity. When load is removed, weighing scales will remain in 2nd range.			
	COUNT	Display internal resolution			
	DECI	Position of the decimal dot			
	div.	div 1	Readability [d] / verification value [e] 1. weighing range		
		div 2	Readability [d] / verification value [e] 2. weighing range		
	CAP	CAP 1	Weighing scale capacity [max] 1. Weighing range		
CAP 2		Weighing scale capacity [max] 2. Weighing range			
CAL	noLin	Adjustment, see chap. 6.9			
	LinEr	For linearization, see chap. Fehler! Verweisquelle konnte nicht gefunden werden.			
GrA	Not documented				
	dUAL 2	Multi-interval balance			
		Weighing scales with one weighing range subdivided into partial weighing ranges, each providing a different scale interval. The scale interval depends on the applied load and is automatically changed during loading and unloading.			
		COUNT	Display internal resolution		
		DECI	Position of the decimal dot		
		div.	div 1	Readability [d] / verification value [e] 1. weighing range	

			div 2	Readability [d] / verification value [e] 2. weighing range
		CAP	CAP 1	Weighing scale capacity [max] 1. Weighing range
			CAP 2	Weighing scale capacity [max] 2. Weighing range
		CAL	noLin	Adjustment, see chap. Fehler! Verweisquelle konnte nicht gefunden werden.
			LinEr	Linearisation, see chap. Fehler! Verweisquelle konnte nicht gefunden werden.
		GrA	Not documented	
P3 OTH s. Kap. 7.10 / 7.11	LOCK	on	Keyboard lock enabled	
		off	Keyboard lock disabled	
	ANM	on	Animal weighing enabled	
		off	Animal weighing disabled	
P4 tAr Restricted taring range		<p>Press , the current setting will be displayed. Using the navigation buttons (see chap. 2.1.1) select the desired setting, the active digit is flashing.</p> <p>Confirm input by .</p>		
P5 St	St on	Follow up tare switched on		
Follow up tare	St off	Follow up tare switched off		
P6 SP	7.5, 15, 30	Not documented		

Tab. 1. Printout examples Standard printer

Lab Prt	0	1	2	3
0~3	***** GS: 5.000kg	***** NT: 5.000kg	***** GS: 5.000kg	***** NT: 5.000kg

	*****	TW: 5.000kg GW: 10.000kg *****	TOTAL: 10.000kg *****	TW: 5.000kg GW: 10.000kg TOTAL: 10.000kg *****
4~7	***** No.: 1 GS: 5.000kg *****	***** No.: 1 NT: 5.000kg TW: 5.000kg GW: 10.000kg *****	***** No.: 1 GS: 5.000kg TOTAL: 10.000kg *****	***** No.: 1 NT: 5.000kg TW: 5.000kg GW: 10.000kg TOTAL: 10.000kg *****

GS / GW	Gross weight	NO	Number weighing processes
NT	Net weight	TOTAL	Total of all individual weighings
TW	Tare weight		

6 Service, maintenance, disposal

6.1 Clean

- Before cleaning, disconnect the appliance from the operating voltage.
- Do not use aggressive detergents (solvents or similar).

6.2 Service, maintenance

The appliance may only be opened by trained service technicians who are authorized by KERN.

Before opening, disconnect from power supply.

6.3 Disposal

Disposal of packaging and appliance must be carried out by operator according to valid national or regional law of the location where the appliance is used.

6.4 Error messages

Error message	Description	Possible causes
- - - - -	Maximum load exceeded	<ul style="list-style-type: none"> • Unload weighing system or reduce

- - ol - -		preload.
Err 1	Incorrect data input	<ul style="list-style-type: none"> Follow format “yy:mm:dd“
Err 2	Incorrect time entry	<ul style="list-style-type: none"> Follow format “hh:mm:ss“
Err 4	Zeroing range exceeded due to switching-on balance or pressing  (normally 4% max)	<ul style="list-style-type: none"> Object on the weighing plate Overload when zeroing
Err 5	Keyboard error	
Err 6	Value outside the A/D changer range	<ul style="list-style-type: none"> Weighing plate not installed Damaged weighing cell Damaged electronics
Err 9	Stability display does not appear	<ul style="list-style-type: none"> Check the environmental conditions.
Err 10	Communication error	<ul style="list-style-type: none"> No data
Err 15	Gravitation error	<ul style="list-style-type: none"> Range 0.9 ~ 1.0
Err 17	Taring range exceeded	<ul style="list-style-type: none"> Reduce load
Fai I h / Fai I l	Adjustment error	<ul style="list-style-type: none"> Repeat adjustment.
Err P	Printer error	<ul style="list-style-type: none"> Check communication parameters
Ba lo / Lo ba	Battery very low	<ul style="list-style-type: none"> Recharge battery

Should other error messages occur, switch balance off and then on again. If the error message remains inform manufacturer.

7 Data output RS 232C

You can print weighing data automatically via the RS 232C interface or manually by pressing



via the interface according to the setting in the menu.

This data exchange is asynchronous using ASCII - Code.

The following conditions must be met to provide successful communication between the weighing system and the printer.

- Use a suitable cable to connect the display unit to the interface of the printer. Faultless operation requires an adequate KERN interface cable.
- Communication parameters (baud rate, bits and parity) of display unit and printer must match. For a detailed description of interface parameters see chap. **Fehler! Verweisquelle konnte nicht gefunden werden.**, menu block „P1 COM“ or „P2 COM“

7.1 Technical data

Connection 9 pin d-subminiature bushing

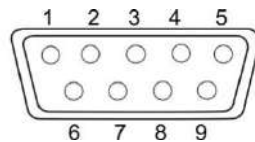

Pin 2 input

Pin 3 output

Pin 5 signal earth

Baud rate Optional 600/1200/2400/4800/9600

Parity 8 bits, no parity / 7 bits, even parity / 7 bits, odd parity

7.2 Printer mode

Printout examples (KERN YKB-01N):

- Weighing

ST, GS	1.000kg
--------	---------

Symbols:

ST	Stable value
US	Instable value
GS / GW	Gross weight
NT	Net weight
TW	Tare weight
NO	Number weighing processes
TOTAL	Total of all individual weighings
<lf>	Space line
<lf>	Space line

- Counting

PCS	100

7.3 Output log (continuous output)

- Weighing

		,		-/□								k	g	CR	LF
HEADER 1		HEADER 2		WEIGHT DATA							WEIGHT UNIT		TERMINATOR		

HEADER1: ST=STABLE , US=UNSTABLE

HEADER2: NT=NET , GS=GROSS

7.4 Remote control instructions

Command	Function	Printout examples
S	Stable weighing value for the weight is sent via the RS232 interface	ST,GS 1.000KG
W	Weighing value for the weight (stable or unstable) is sent via the RS232 interface	US,GS 1.342KG ST,GS 1.000KG
T	No data are sent, the balance carries out the tare function.	-
Z	No data are sent, the zero-display appears.	-
P	Quantity will be sent via the RS232-interface	10PCS

8 Instant help

In case of an error in the program process, briefly turn off the display unit and disconnect from power supply. The weighing process must then be restarted from the beginning.

Help:

Fault

Possible cause

The displayed weight does not glow.

- The display unit is not switched on.
- Mains power supply interrupted (mains cable defective).
- Power supply interrupted.
- (Rechargeable) batteries are inserted incorrectly or empty
- No (rechargeable) batteries inserted.

The displayed weight is permanently changing

- Draught/air movement
- Table/floor vibrations
- Weighing pan has contact with other objects.
- Electromagnetic fields / static charging (choose different location/switch off interfering device if possible)

The weighing result is obviously incorrect

- The display of the balance is not at zero
- Adjustment is no longer correct.
- Great fluctuations in temperature.
- Warm-up time was ignored.
- Electromagnetic fields / static charging (choose different location/switch off interfering device if possible)

Should other error messages occur, switch display unit off and then on again. If the error message remains inform manufacturer.

9 Installing display unit / weighing bridge



- Installation / configuration of a weighing system must be carried out by a well acquainted specialist with the workings of weighing balances.

9.1 Technical data

Supply voltage:	5 V/150mA
Max. signal voltage	0-10 mV
Zeroing range	0-2 mV
Sensitivity	2-3 mV/V
Resistance parameter	80 - 100 Ω , max 4 items per 350 Ω load cell

9.2 Weighing system design

The display unit is suitable for connection to any analogue platform in compliance with the required specifications.

The following data must be established before selecting a weighing cell:

- **Weighing balance capacity**
This usually corresponds to the heaviest load to be weighed.
- **Preload**
This corresponds to the total weight of all parts that are to be placed on the weighing cell such as upper part of platform, weighing pan etc.
- **Total zero setting range**
This is composed of the start-up zero setting range ($\pm 2\%$) and the zero setting range available to the user via the ZERO-key (2%). The total zero setting range equals therefore 4 % of the scale's capacity.

The addition of weighing scales capacity, preload and the total zero setting range give the required capacity for the weighing cell.
To avoid overloading of the weighing cell, include an additional safety margin.

- **Smallest desired display division**
- **Verifiability, if required**
The application of the display unit as a verified weighing system requires that you short-circuit the two contacts [K1] of the circuit board, using a jumper; for position see chap. **Fehler! Verweisquelle konnte nicht gefunden werden..**
Remove the jumper for weighing systems not able to be verified.

9.3 How to connect the platform

- ⇒ Disconnect the display unit from the power supply.
- ⇒ Solder the individual leads of the load cell cable onto the circuit board. See diagrams below.

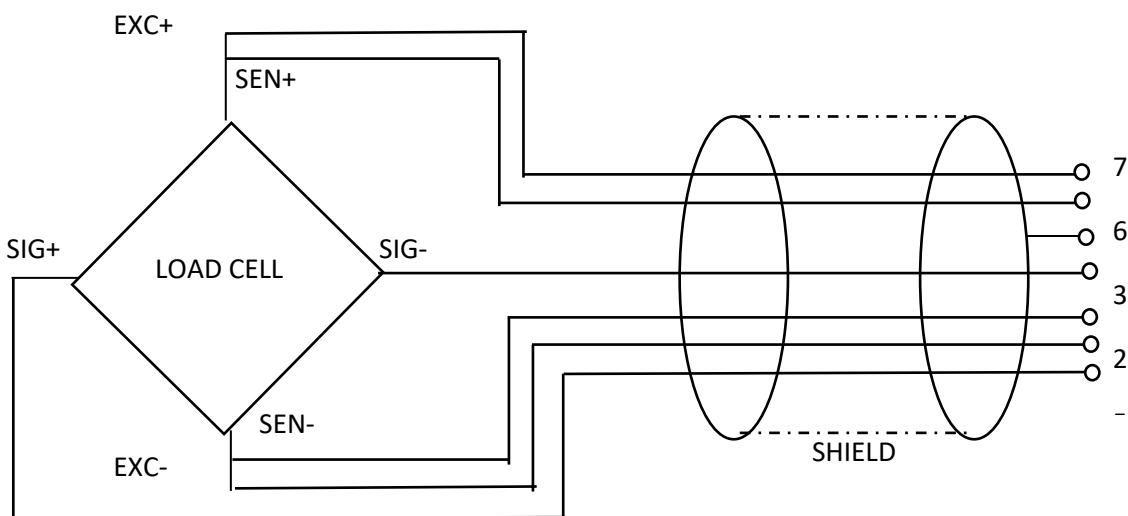

PIN	Loadcell	
	6- conductor	4- conductor
7	EXC+	EXC+
6	SEN+	
5	EXC-	EXC-
4	SEN-	
3	SHIELD	SHIELD
2	SIG-	SIG-
1	SIG+	SIG+

9.4 Configure display unit

9.4.1 Verified weighing systems

(contacts of circuit board [K1] short-circuited by means of jumper)

For menu overview see chap. 5.2.

In verified weighing systems the menu item for calibration „P2 mode“ is blocked.

KERN KFB-TM:















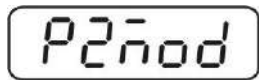

To disable the access lock, destroy the seal and actuate the adjustment switch.
Position of the adjustment switch see chap. **Fehler! Verweisquelle konnte nicht gefunden werden.**

KERN KFN-TM:











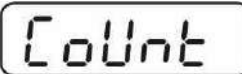



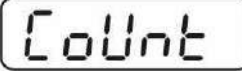



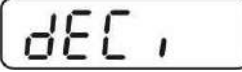

To override the blocked access you will have to destroy the seal before calling up the menu and to short-circuit the two contacts on the circuit board [K2], using a jumper (See chap. **Fehler! Verweisquelle konnte nicht gefunden werden.**).

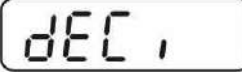













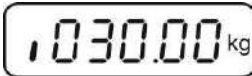



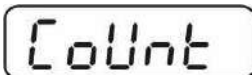

Attention:



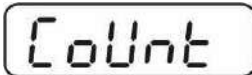













After destruction of the seal the weighing system must be re-verified by an authorised agency and a new verification wire/seal mark fitted before it can be reused for applications subject to verification.

<p>Call up menu:</p> <p>⇒ Switch-on balance and during the selftest press .</p>	
<p>⇒ Press , ,  subsequently, the first menu block „PO CHK“ will be displayed.</p>	
<p>⇒ Press  repeatedly until „P2 mode“ will be displayed.</p> <p>⇒ Operate the adjustment switch (models KFB-TM).</p>	
<p>⇒ Press  and use  to select the weighing scales type.</p> <p> Single-range balance</p> <p> Dual range balance</p> <p> Multi-interval balance</p>	    



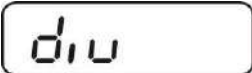

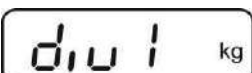
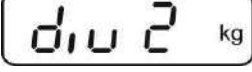

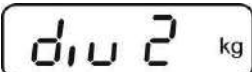
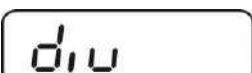



Example single range scales *SICr* (d = 10 g, max. 30 kg)

<p>⇒ Confirm selected weighing scales type by pressing ; the first menu item „COUNT“ will be shown.</p>	
<p>1. Display internal resolution</p> <p>⇒ Press , the internal resolution will be shown.</p> <p>⇒ Return to menu by .</p> <p>⇒ Press  to select the next menu item.</p>	  
<p>2. Position decimal point</p> <p>⇒ Press , the currently set position of the decimal dot is displayed.</p> <p>⇒ Press  to select the desired setting. Options 0, 0.0, 0.00, 0.000, 0.0000.</p> <p>Confirm input by .</p> <p>⇒ Press  to select the next menu item.</p>	  
<p>3. Readability</p> <p>⇒ Press  and current setting will be displayed.</p> <p>Select desired setting by .</p> <p>Options 1, 2, 5, 10, 20, 50.</p> <p>Confirm entry by .</p> <p>⇒ Press  to select the next menu item.</p>	  

<p>4. Capacity</p> <p>⇒ Press , the current setting will be displayed.</p> <p>Using the navigation buttons (see chap. 2.1.1) select the desired setting, the active digit is flashing.</p> <p>Confirm input by .</p> <p>⇒ Press  to select the next menu item.</p> <p>5. Adjustment / linearization Adjustment or linearization is required after entering configuration data. For carrying out adjustment see chap. Fehler! Verweisquelle konnte nicht gefunden werden./step 6 or chap. Fehler! Verweisquelle konnte nicht gefunden werden. for linearisation</p>	   
<p>Example dual range scales <i>dUAL 1</i> (d = 2 / 5 g, max. 6 / 15 kg)</p>	
<p>⇒ Confirm selected weighing scales type by ; the first menu item „COUNT“ will be shown.</p>	
<p>1. Display internal resolution</p> <p>⇒ Press , the internal resolution will be shown.</p> <p>⇒ Return to menu by .</p> <p>⇒ Press  to select the next menu item.</p>	  
<p>2. Position decimal point</p> <p>⇒ Press , the currently set position of the decimal dot is displayed.</p> <p>⇒ Use  to select the desired setting. Options 0, 0.0, 0.00, 0.000, 0.0000.</p> <p>Confirm input by .</p>	 

<p>⇒ Press  to select the next menu item.</p>	
<p>3. Readability</p> <p>⇒ Press , the display used to enter readability/verification value for first weighing range will appear.</p> <p>⇒ Press , the current setting will be displayed.</p> <p>⇒ Select desired setting with  and acknowledge by .</p> <p>⇒ Press  to enter the next menu item for readability/verification value for second weighing range.</p> <p>⇒ Press , and current setting will be displayed.</p> <p>⇒ Select desired setting with  and acknowledge by .</p> <p>⇒ Press , the unit will return to the menu</p> <p>⇒ Press  to select the next menu item.</p>	       

4. Capacity

- ⇒ Press  and the display for entering the capacity for the first weighing range will appear.
- ⇒ Press  and current setting will be displayed.
- ⇒ Select desired setting with  and acknowledge by .
- ⇒ Press  to select the next menu item used to enter the capacity for the second weighing range.
- ⇒ Press  and current setting will be displayed.
- ⇒ Select desired setting with  and acknowledge by .
- ⇒ Press , the unit will return to the menu
- ⇒ Use  to select next menu item.

CAP

CAP 1

1006.00 kg

CAP 1

CAP 2

1015.00 kg

CAP 2

CAP

CAL

noLin



↓↑

LinEr

5. Adjustment / linearization

















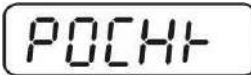

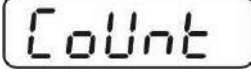

Adjustment or linearization is required after entering configuration data.





















For carrying out adjustment see chap. **Fehler! Verweisquelle konnte nicht gefunden werden.**/step 6 or chap. **Fehler! Verweisquelle konnte nicht gefunden werden.** for linearisation

- ⇒ Acknowledge using , the current setting is displayed.
- ⇒ Acknowledge by , select desired setting with 
noLin = Adjustment
LinEr = Linearisation

9.4.2 Non verifiable weighing systems (contacts of circuit board [K1] not short-circuited)



+ For menu overview see chap. 5.1.

<p>Call up menu</p> <p>⇒ Switch-on balance and during the selftest press  .</p> <p>⇒ Press , ,  subsequently , the first menu block „PO CHK“ will be displayed.</p> <p>⇒ Press  repeatedly until „CAL“ will be displayed.</p> <p>⇒ Press , the first menu item „COUNT“ will be displayed.</p>	   
<p>Navigation in the menu</p> <p>⇒ With help of , the individual menu items can be selected one after the other.</p> <p>⇒ Confirm selected menu item by pressing . The current setting will be displayed.</p> <p>⇒ To change to the available settings, press the navigations keys as described in chap. 2.1.1.</p> <p>⇒ Either save by pressing  or cancel by pressing .</p> <p>⇒ Press  repeatedly to exit menu.</p>	
<p>Parameter selection</p> <p>1. Display internal resolution</p> <p>⇒ Press , the internal resolution will be shown.</p> <p>⇒ Return to menu by .</p> <p>⇒ Use  to select another menu item.</p>	  
<p>2. Position decimal point</p>	

<p>⇒ Press , the currently set position of the decimal dot is displayed.</p> <p>To make changes using the navigation keys (See chap. 2.1.1), select the desired setting. Options 0, 0.0, 0.00, 0.000, 0.0000.</p> <p>Confirm input by .</p> <p>⇒ Use  to select another menu item.</p>	 
<p>3. Weighing scales type, capacity and readability</p> <p>⇒ Press  and current setting will be displayed.</p> <p>⇒ Select desired setting by .</p> <p>„off“ Single-range balance „on“ Dual range balance</p> <p>⇒ Press  to confirm, the display for entering readability (for dual range scales for the first weighing range) appears.</p> <p>⇒ Press , the current setting will be displayed.</p>	   
<p>⇒ Select desired setting with  and acknowledge by .</p> <p>⇒ Press , the display for entering capacity will appear (at dual range balance for the first range).</p> <p>⇒ Press , the current setting will be shown (such as max. = 2000kg).</p> <p>⇒ Using the navigation buttons (see chap. 2.1.1) select the desired setting, the active digit is flashing.</p> <p>⇒ Acknowledge with .</p> <p>In a single-range balance the entry of capacity / readability is</p>	  

finished.

either in single-range balance

⇒ Press , the unit will return to the menu Press  to call up next menu item „CAL“.

or

In a **dual range balance** enter readability/verification value and capacity of the second weighing range.

⇒ Press , the display for entering the capacity of the second weighing range will appear.

⇒ Press , the current setting will be displayed.

⇒ Using the navigation buttons (see chap. 2.1.1) select the desired setting, the active digit is flashing.

⇒ Confirm input by  .

r 1CAP

r 2CAP

1.00000 kg

r 2CAP

⇒ Press , the display for entering the readability of the second weighing range will appear.

⇒ Press , the current setting will be displayed.

⇒ Select desired setting with  and acknowledge by .

⇒ Press , the unit will return to the menu

⇒ Press  to call next menu item.

r 2 inC

1

r 2 inC

DUAL

4. Adjustment or linearisation

Adjustment or linearisation is required after entering configuration data.

For carrying out adjustment see chap. **Fehler! Verweisquelle konnte nicht gefunden werden.**/step 4 or chap. **Fehler! Verweisquelle konnte nicht gefunden werden.** for linearisation

⇒ Acknowledge using , the current setting is displayed.

⇒ Press  to confirm, press  to select the desired setting

CAL



noLin

↑

noLin = Adjustment
LineAr = Linearisation

LinEr

10 MAINTENENCE

	 WARNING
	DISCONNECT ALL POWER TO THIS UNIT BEFORE INSTALLING, CLEANING, OR SERVICING. FAILURE TO DO SO COULD RESULT IN BODILY HARM OR DAMAGE THE UNIT.

 CAUTION
<ul style="list-style-type: none">• Permit only qualified persons to service the instrument• Before connecting or disconnecting any components, remove the power.• Failure to observe these precautions bodily harm or damage to or destruction of the equipment.

10.1 General

If the scale does not operate properly, find out the problem as possible.

Determine whether the problem is constant or alternate. Be aware that problems can be caused by mechanical or electrical influences.

Check the following.

- Water
- Corrosive materials
- Vibrations or temperature or wind
- Physical damage

Check the indicator cables for damage, and check all connections and connectors for any loose contact or incorrect connection

10.2 Error Codes

Indicator's error message's following lists

ERROR CODES	DESCRIPTION	RESOLUTION
-----	Over load	Weight on the scale exceeds calibrated capacity. Decrease load on the scale. If the problem persists re calibrate the scale
Err 4	Scale not zeroed at power up	Auto Zero on power up is exceeded due to switching on.(4%max) Zero the scale or remove the weight. Re calibrate the scale.
Err 6	A/D out of range	The values of the A/D converter are outside from the normal range. Remove the weight from the scale if overloaded and make sure the pan is attached. Load cell or the electronics may be faulty.

9.3. Determine the Problem

Determine whether the problem is in the indicator or the platform

- Remove power from the system, and disconnect the indicator from the platform
- Connect the indicator to a load cell simulator
- Reapply power and test the indicator
- If problem goes away, its source is probably in the platform. Check the wiring, connector, load cells and mechanical components of the platform. If problem persists, its source is probably in the indicator. Check the indicator voltages, connectors, cables and function programs.

10.3 Check the Load cell

- Remove power from the system, and disconnect the indicator from the platform
- Remove the load connector from platform terminal.
- Check the moisture, or foreign material inside.
- Make sure all leads are connected and correctly. See the details of connections in the Installation section.
- Check load cell for proper input and output resistances

Measuring Points	Resistance
+ Exc to –Exc (Input)	Minimum 350 ohms
+Sig to –Sig (Output)	347 ~ 353 ohms

10.4 Check Indicator Voltages

If the problem is in the Indicator, use a multimeter to check the following voltages

10.4.1 AC Power

Check the AC power socket out put voltage.

- Voltage must be a -20% and +10% of the normal AC voltage.

10.4.2 Adaptor Voltage

Check the adaptor output cable connector voltage

- Voltage must be minimum 9VDC and maximum 15VDC

10.4.3 PCB Input Voltage

Check the PCB input power connector voltage

- Voltage must be minimum 9VDC in to the pin AD+

10.4.4 Check Battery Voltage and Charging Voltage

1. Check the Battery Voltage,

- Voltage must be minimum 6VDC. If below the 6VDC connect the adaptor for charging
- The battery voltage below the 5.5VDC, replace the battery and install new 6V/4Ah battery.

2. Check the Battery Charging Voltage;

- Remove the battery connection terminals (Red and Black) from the battery.
- Connect the power and turn on the Indicator
- Voltage into the terminal minimum 6.5VDC

10.5 Problems and Solutions

Problems	Possible cause	Common Solutions
Display is blank. No self test	Mains power is turned off. Power supply faulty or not plugged. Internal battery is not charged. On/Off switch problem	Check power is getting inside the scale and on/off switch is working. Verify the voltages, which is on the power labels.
Blank display after self test	Pan not installed. Unstable weight, load cell damaged	Check the pans are installed correctly. Try to turning on again.
OL or -----	Maximum capacity exceeded. Load cell or mechanics damaged. Power supply faulty	Check the platform is installed correctly. Try to turn on the scale again. Do the calibration again
----- or NULL displayed	Weight is on the platform is below permissible limit. Pan not installed correctly. Power supply faulty. Load cell or mechanism faulty	Check the platform is installed correctly. Try to turn on the scale again. Do the calibration again
Display is unstable	Goods touching somewhere. Air variation or any vibrations. Temperature changed . Load cell or connections faulty. Power supply faulty	Check the scale is in acceptable location. Check the connectors and load cell. Check the power supply and battery
Weight value incorrect	Calibration error. Platform of load cell touching somewhere. Wrong weighing unit	Use accurate weight for to do the calibration Check the pan and load cell is installed proper and touching. Check the parameter settings.

		Check the load cell and connectors
Can not use full capacity	<p>Over load protection stoppers or transport locks are not removed.</p> <p>Parameters are set incorrectly.</p> <p>AD problem.</p> <p>Load cell or mechanism damaged</p>	<p>Check the stoppers and locks under the platform.</p> <p>Check the weighing unit and parameter settings.</p> <p>Check the load cell.</p>
Platform Corner Weight different	<p>Over load protection stoppers or transport locks are not removed.</p> <p>Load cell or mechanism damaged</p>	<p>Check the stoppers and locks under the platform.</p> <p>Use accurate weight for to do the calibration</p> <p>Check the load cell.</p>
Battery not charging	<p>Mains voltage problem</p> <p>Charging circuit problem</p> <p>Battery Problem</p>	<p>Check the mains and adaptor.</p> <p>Check the battery.</p> <p>Check the charging circuit</p>

11 10. TROUBLE SHOOTING

11.1 No Power

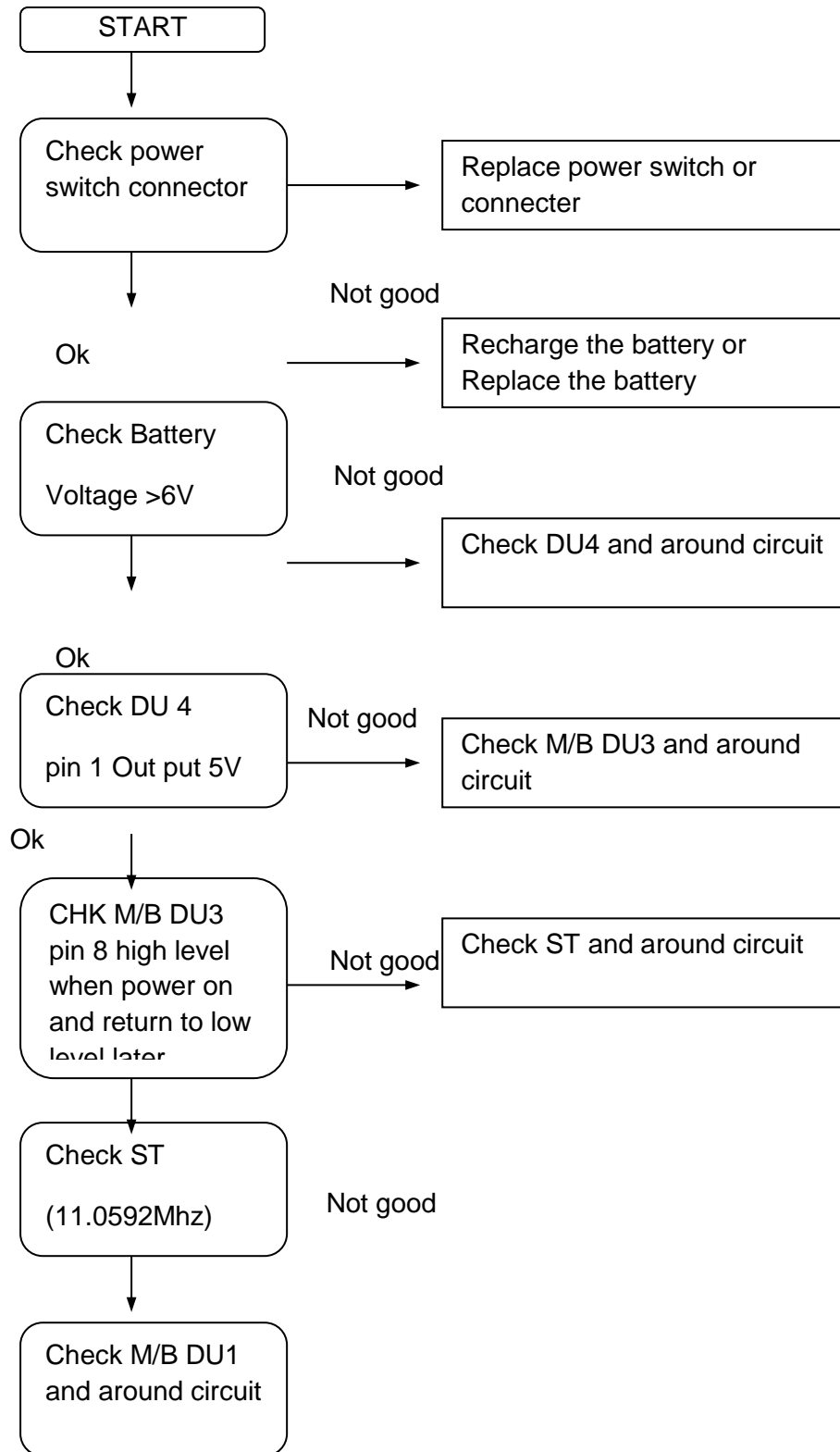

No Display

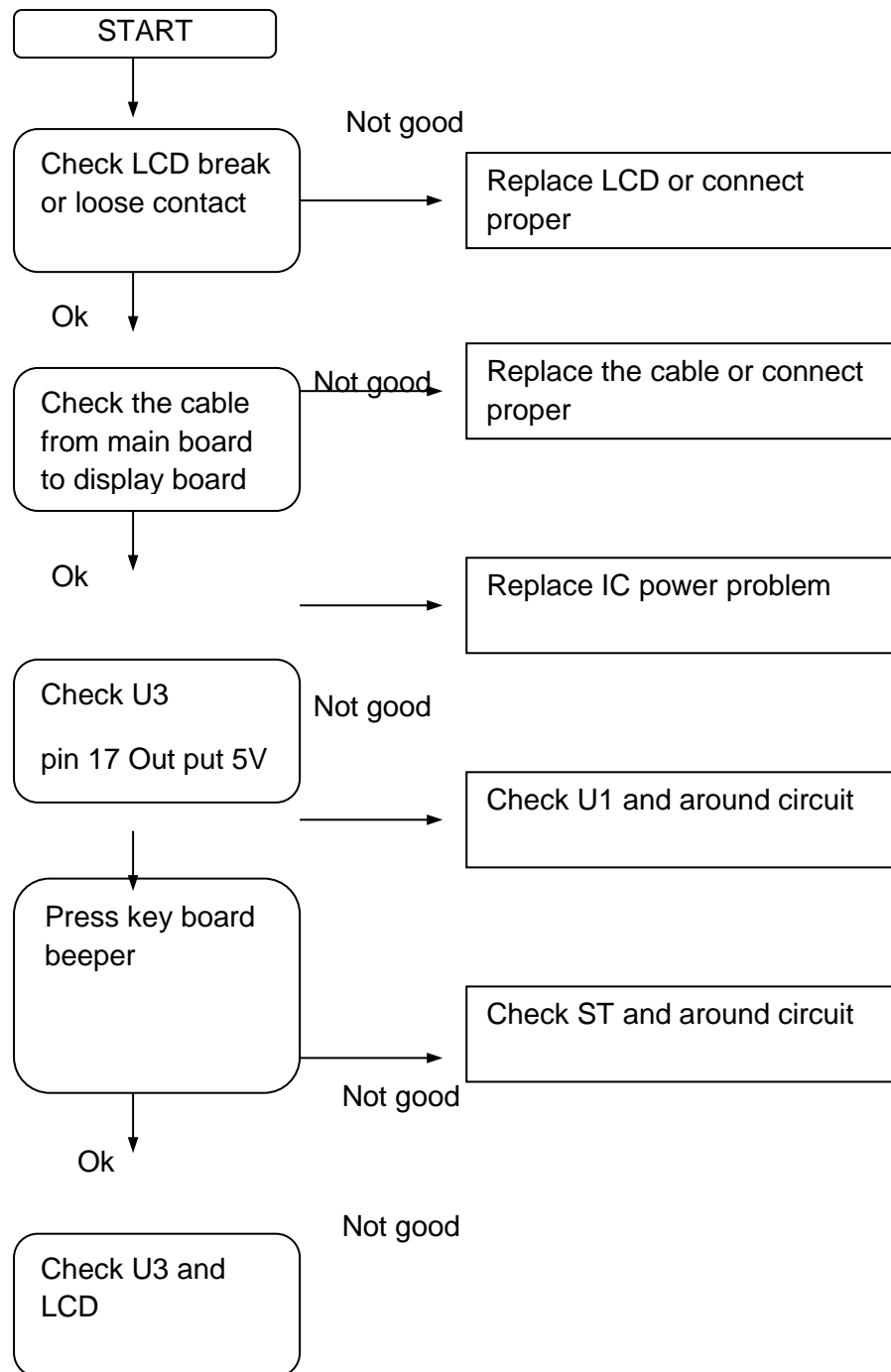

Battery not charging

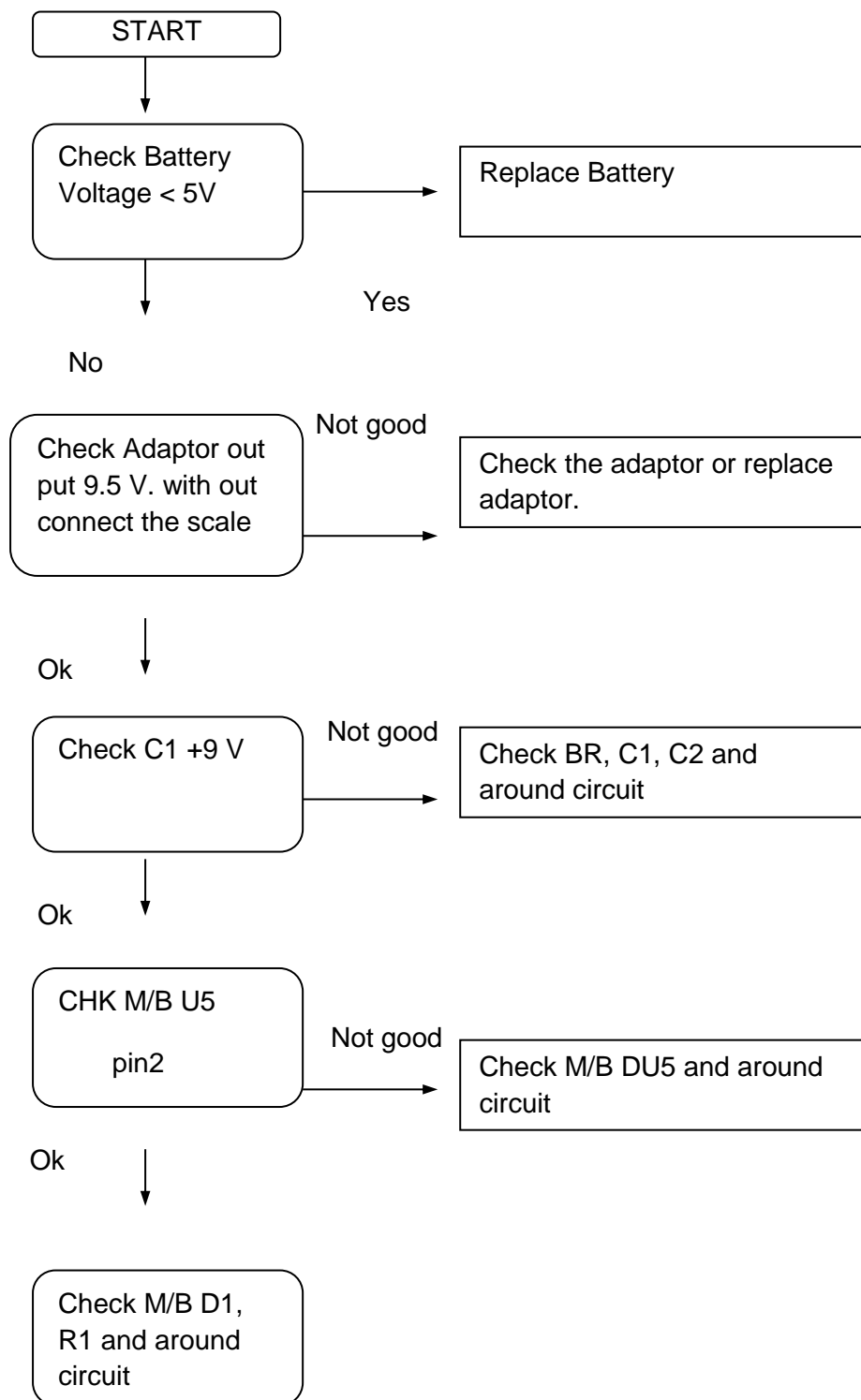

11.2 Not Weighing

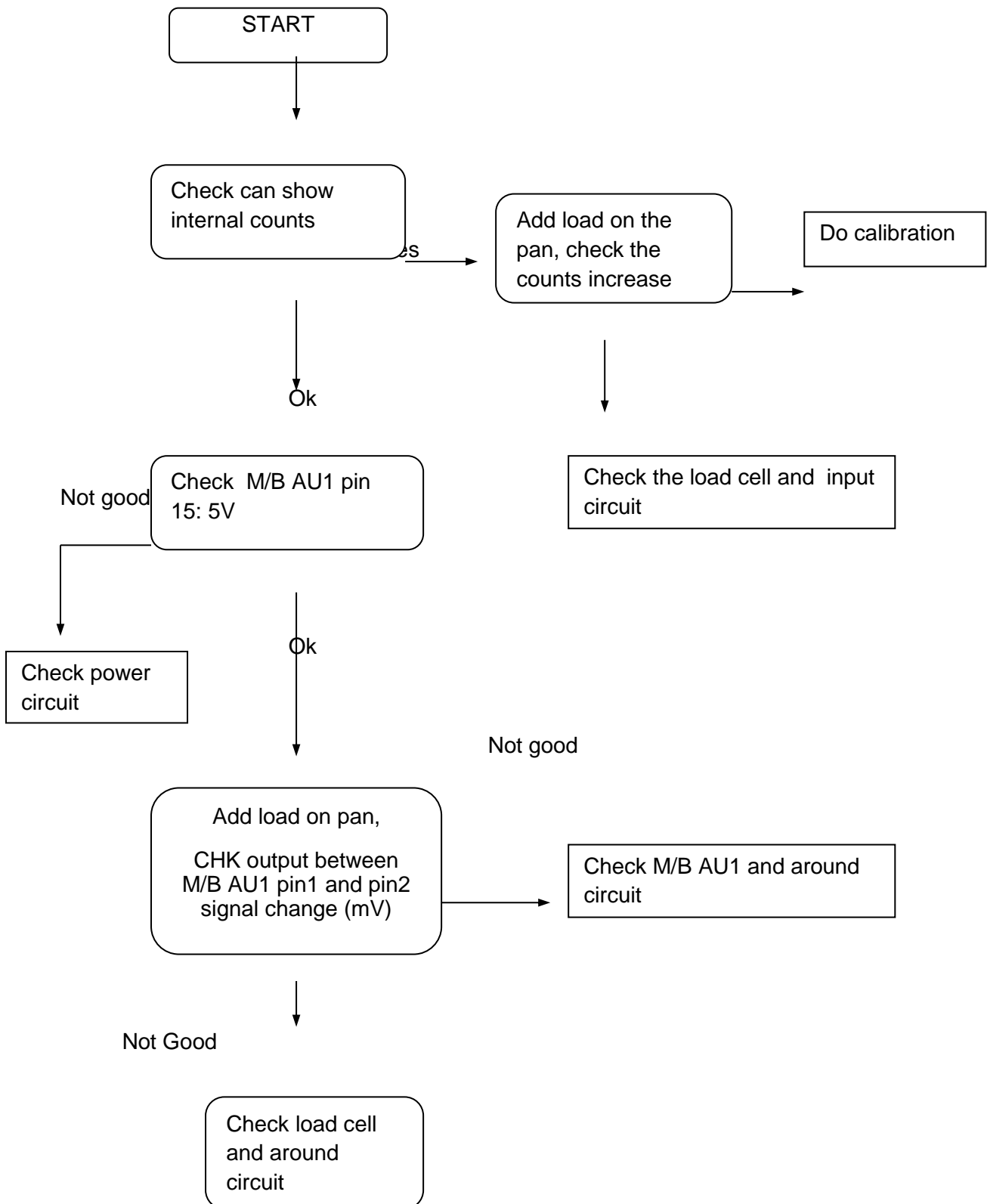

11.3 Unstable

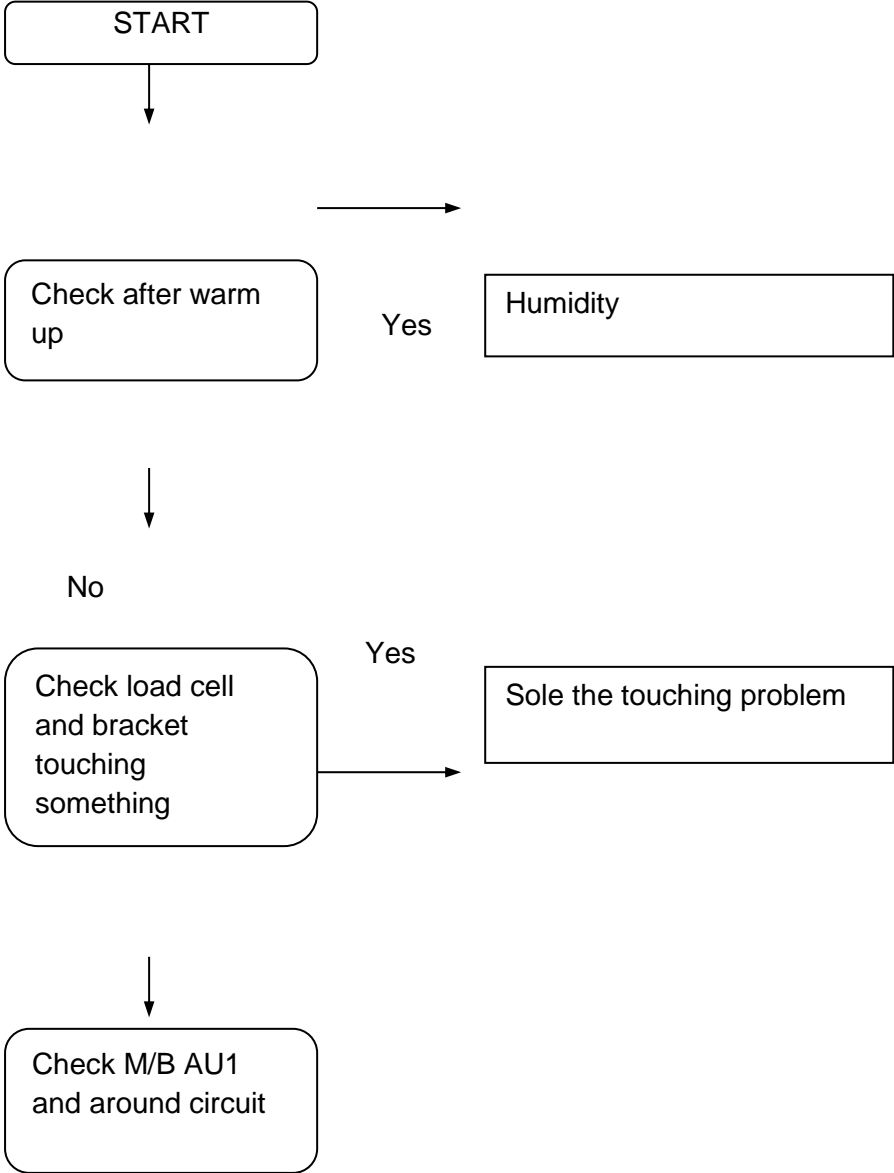

12 11. CIRCUIT DIAGRAM

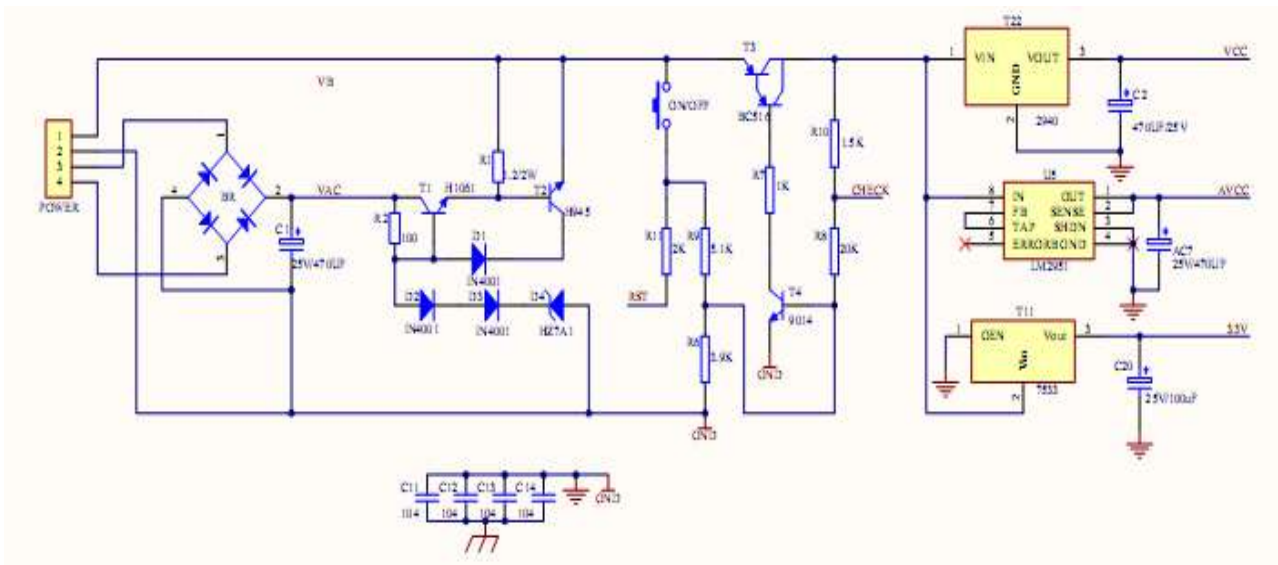

Power

Display

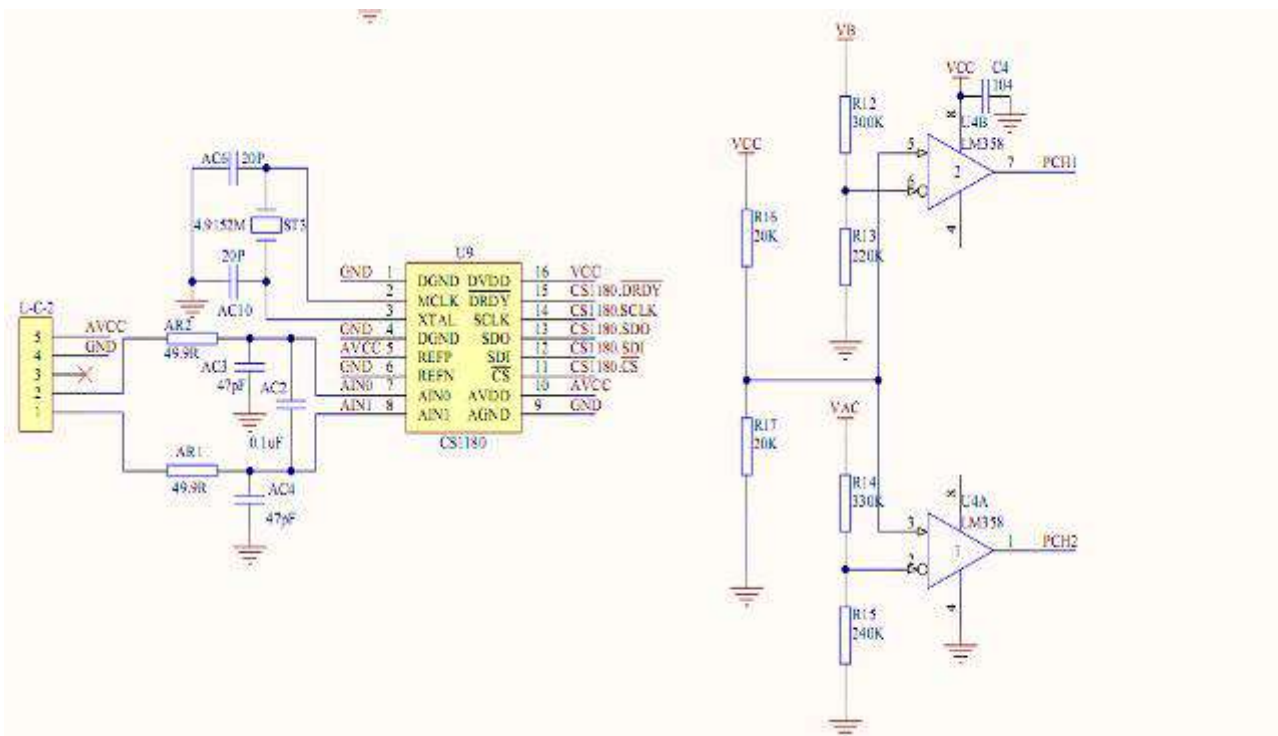

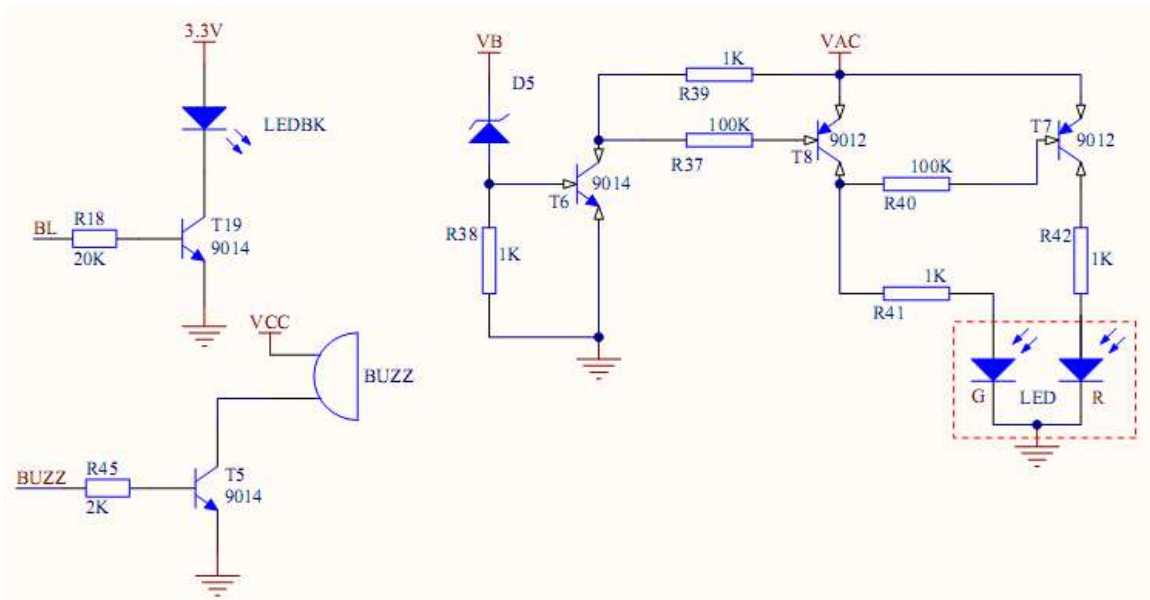
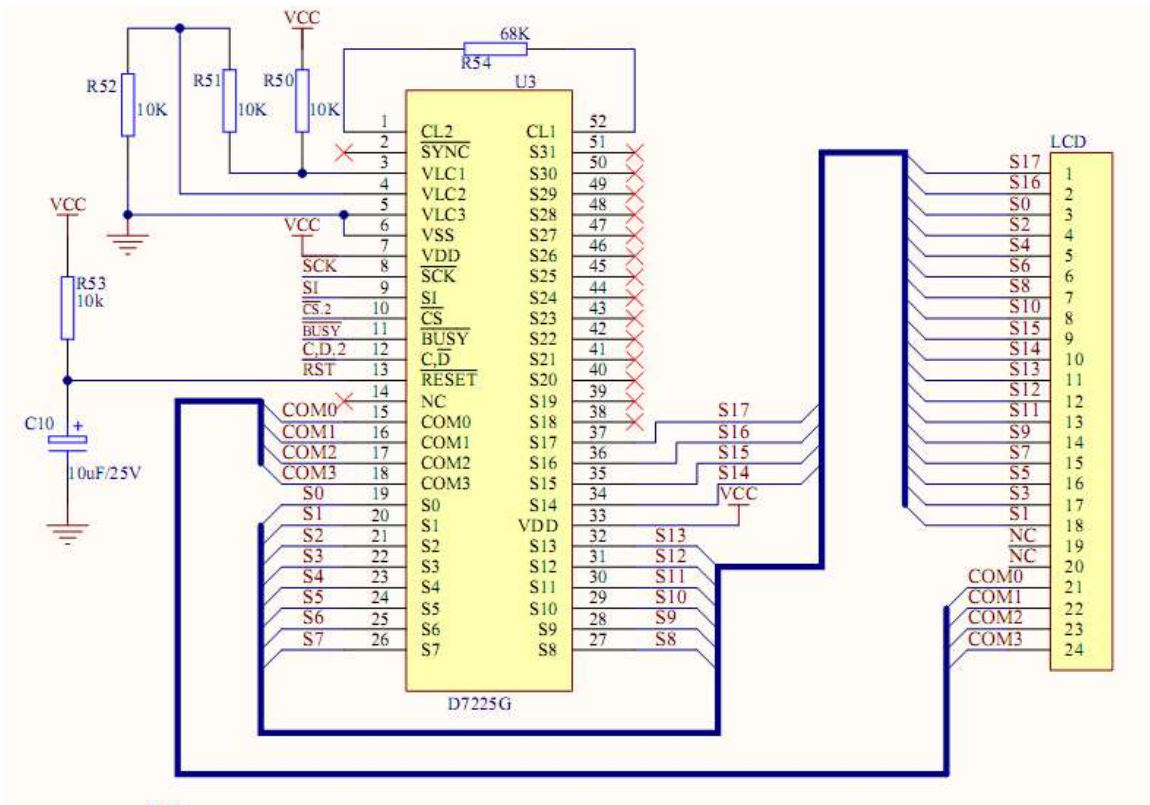

CPU

KFB-TAM/KFN-TAM-SH-e-1810

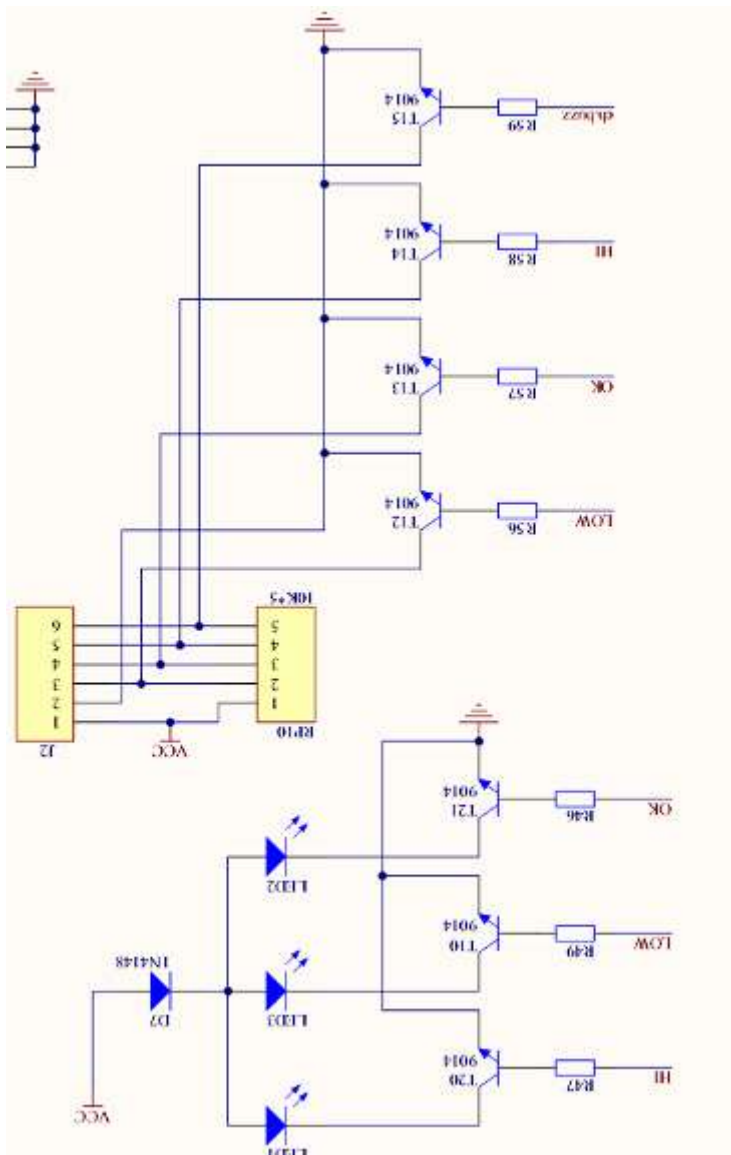

13 DRAWING

13.1 Drawing KFB-TM

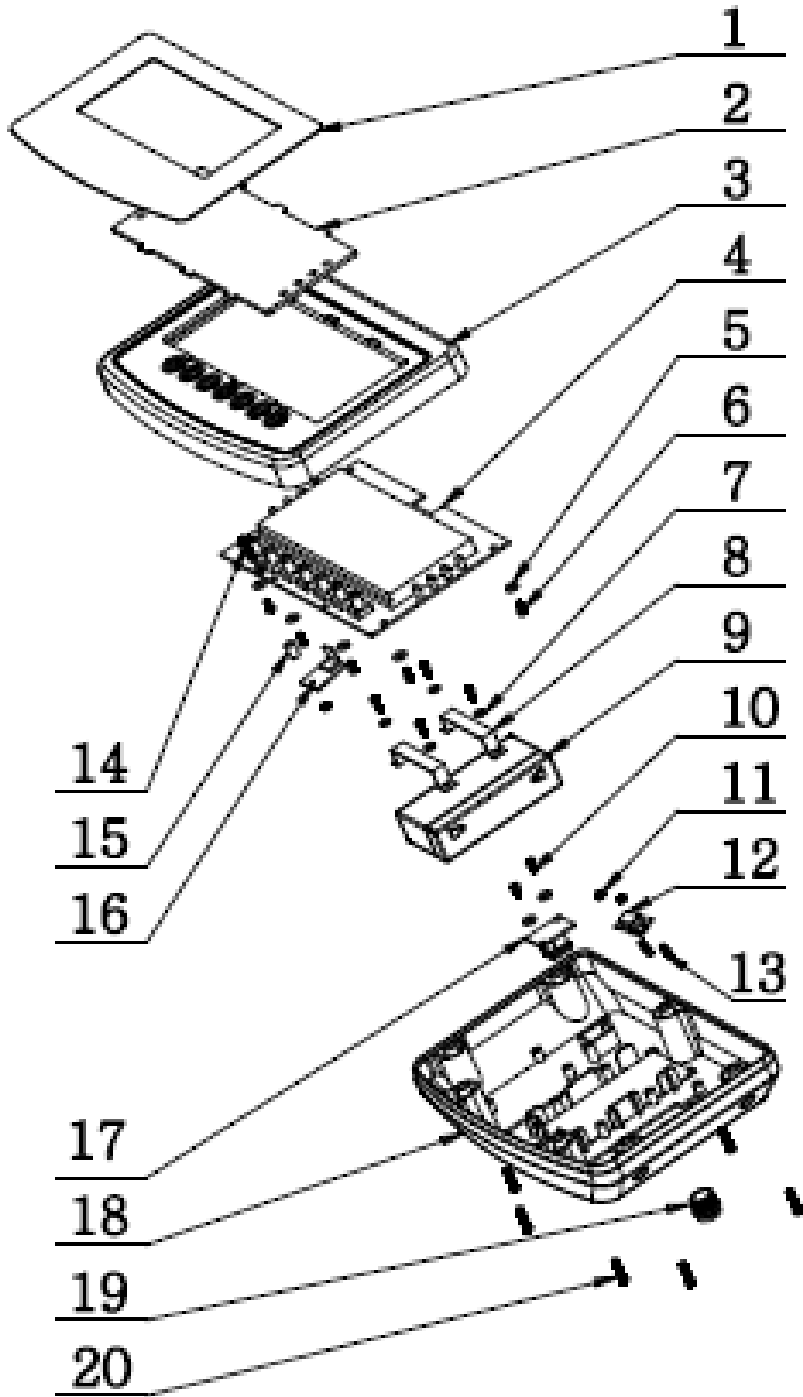

13.2 Parts List

No	Parts Name	Qty	Spec
1	Key Panel	1	
2	Display Protection Plate	1	
3	Front Cover	1	
4	Main PCBA	1	
5	Insulation Washer	9	
6	Self Thread Screw	10	3x10
7	Washer	4	
8	Battery bar	2	
9	Battery	1	6V/1.2AH
10	Self Thread Screw	2	M3
11	Nut	3	M3, Hexagon
12	RS-232 port	1	
13	D Connector	1	
14	Star (+) Screw	1	3Mx20
15	Branch pipe	1	
16	Main Serial board	1	
17	Interface Module	1	
18	Back Cover	1	
19	Air Connector	1	
20	Star (+) Screw	7	M4x16

13.3 Drawing KFN-TM

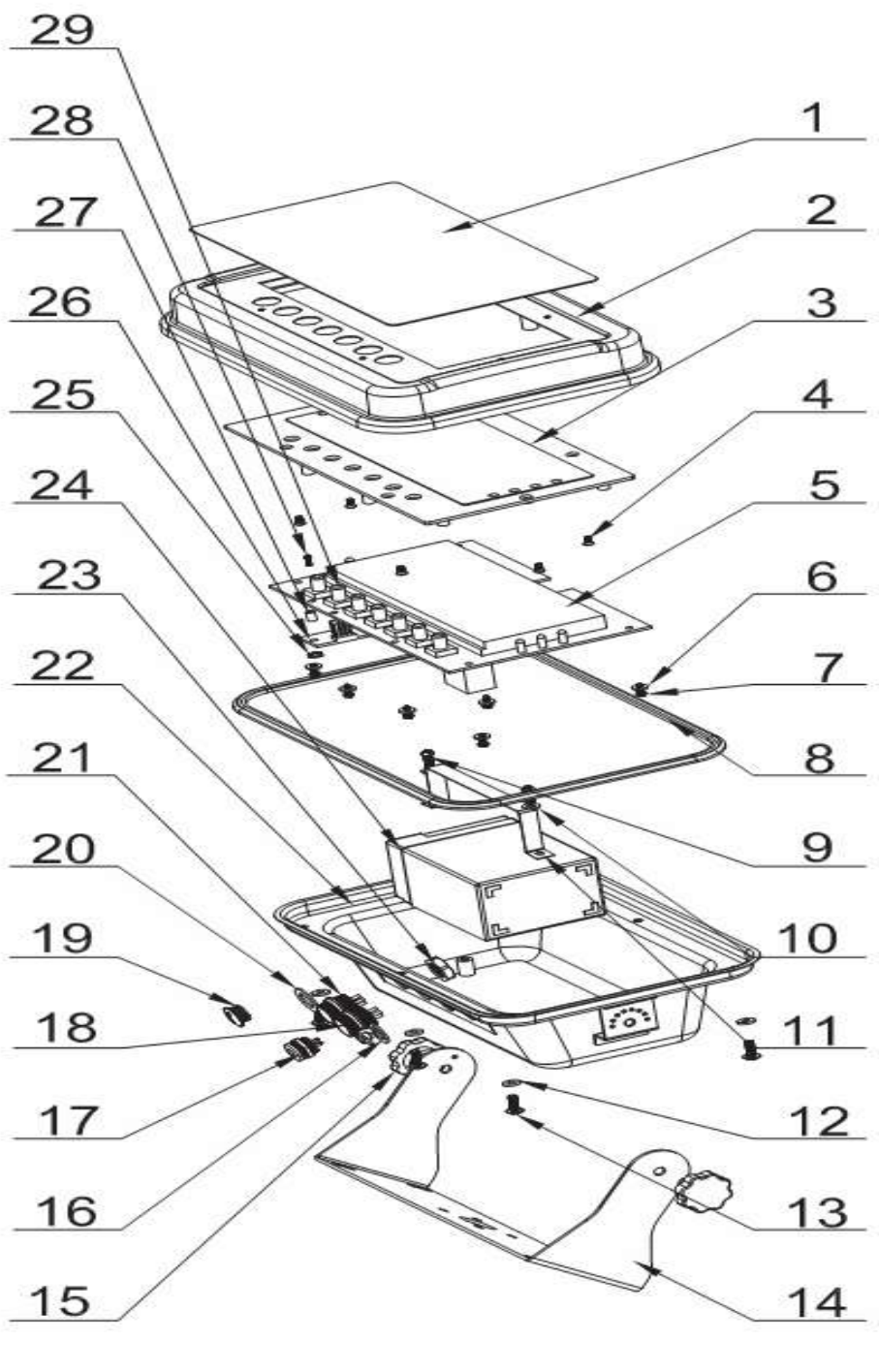

13.4 Parts List

No	Parts	Qty	Spec
1	Key Panel	1	
2	Front Cover	1	
3	Display Protection Plate	1	
4	Nut	6	M3*6
5	Main PCBA	1	
6	Washer	6	8x3.1x1.5
7	Star (+) Self Thread screw	6	M3x8
8	Water Proof Rubber Bar	1	
9	Star (+) Screw	2	M4x10
10	Washer	2	M4
11	Battery Clamp	1	
12	Washer	6	M4
13	Star (+) Big head Screw	6	M4x12
14	Bracket	1	
15	Bracket Screw	2	
16	Water Proof Adaptor jack	1	
17	Interface Module	1	
18	Air connecter	1	5Pin
19	Plug	1	
20	Rubber Spacer	3	
21	Air Connector	1	7Pin
22	Back Cover	1	
23	Air Connector Water Proof Nut	1	
24	Battery	1	6V/4Ah
25	Nut	1	M3x6
26	Main Serial board	1	

27	Spacer	1	
28	Star (+) Screw	1	3Mx20
29	Micro Switch Cap	7	