

User instructions

Transmitted light phase contrast microscope

KERN OBL-14, OBL-15

OBL 145, OBL 155

Version 1.0
01/2016

Importør:
Impex Produkter AS
Gamle Drammensvei 107
1363 Høvik
www.impex.no
info@impex.no
Tel.: 22 32 77 20





KERN OBL-14, OBL-15

Version 1.0 01/2016

User instructions

Phase contrast microscope

Table of contents

1	Before use	3
1.1	General notes.....	3
1.2	Notes on the electrical system.....	3
1.3	Storage	4
1.4	Maintenance and cleaning.....	5
2	Nomenclature.....	6
3	Technical data / Features	8
4	Assembly.....	10
4.1	Microscope head	10
4.2	Objectives	10
4.3	Eyepieces	10
4.4	Colour filter	10
4.5	PH condenser + PH slide	11
5	Operation.....	11
5.1	Getting started	11
5.2	(Pre-) focussing	12
5.3	Adjusting the interpupillary distance	13
5.4	Dioptre adjustment.....	13
5.5	Adjusting the magnification	14
5.6	Adjusting the Koehler illumination.....	15
5.7	Using eye cups	17
5.8	Using oil immersion objectives	18
5.9	Phase contrast unit	19
6	Changing the bulb	21
7	Changing the fuse.....	22
8	Using optional accessories.....	22
8.1	Camera connection	22
9	Trouble shooting.....	23
10	Service	25
11	Disposal.....	25
12	Further information.....	25

1 Before use

1.1 General notes

You must open the packaging carefully, to make sure that none of the accessories in the packaging fall on the floor and get broken.

In general, microscopes should always be handled carefully because they are sensitive precision instruments. When using or transporting the microscope it is particularly important to avoid abrupt movements, as this may damage the optical components.

You should also avoid getting dirt or finger prints on the lens surface, because in most cases this will reduce image clarity.

To maintain the performance of the microscope, it must never be disassembled. So components such as lenses and other optical elements should be left as they were before use. Also the electrical parts on the rear and base of the device must not be tampered with, as in this area there is an additional risk of triggering an electric shock.

1.2 Notes on the electrical system

Before connecting to a mains power supply, you must make sure that you are using the correct input voltage. The information to select the correct mains cable is located on the device, on the rear of the product directly above the connection socket. You must comply with this information. If you do not comply with these specifications, then fires or other damage to the device could occur.

The main switch must also be switched off before the mains cable is connected. In this way you will avoid triggering an electric shock.

If you are using an extension cable, then the mains cable you use must be earthed.

If the original fuse should blow, it must only be replaced by an appropriate fuse. Suitable replacement fuses are included with the delivery.

When carrying out any procedures whereby you come into contact with the electrical system of the device, such as, for example, changing the bulb or fuse, only carry out these procedures when the power is disconnected.

Under no circumstances should you touch the integrated halogen bulbs either during operation or directly after use. These bulbs produce significant heat and therefore there is a risk that the user could be severely burnt. So before handling the bulbs, you must check that they have cooled down.

The microscope housing, on the other hand, is constructed so that no significant heat radiation emanates from the device and that there is absolutely no risk of the user burning themselves from the housing outer surfaces.

1.3 Storage

You should ensure that the device is not exposed to direct sunlight, temperatures which are too high or too low, vibrations, dust or a high level of humidity.

The ideal temperature range is between 0 and 40°C and a relative humidity of 85% should not be exceeded.

The device should always be located on a rigid, smooth, horizontal surface.

When the microscope is not being used, you should cover it with the enclosed dust protective cover. When doing this, the power supply is stopped by switching off at the main switch and unplugging the mains cable. If the eyepieces are being stored separately, the protective caps must be fitted to the tube connectors. In most cases, if dust and dirt gets inside the optical unit of a microscope this can cause irreversible errors or damage.

The best way to store accessories which consist of optical elements, such as, for example, eyepieces and objectives, is in a dry box with desiccant.

1.4 Maintenance and cleaning

In any event, the device must be kept clean and dusted regularly.

If any moisture should occur, before you wipe down the device you must ensure that the mains power is switched off.

When glass components become dirty, the best way to clean them is to wipe them gently with a lint-free cloth.

To wipe oil stains or finger prints off the lens surface, moisten the lint free cloth with a mixture of ether and alcohol (70 / 30 ratio) and use this to clean the lens.

You must be careful when handling ether and alcohol, as these are highly flammable substances. You must therefore keep it away from naked flames and electrical devices which can be switched on and off, and only use it in well-ventilated rooms.

However organic solutions of this type should not be used to clean other components of the device. This could lead to damage to the paint finish. To do this, it is sufficient to use a neutral cleaning product.

You could also use the following cleaning products to clean the optical components:

- Special cleaner for optical lenses
- Special optical cleaning cloths
- Bellows
- Brush

When handled correctly and checked regularly, the microscope should give many years of efficient service.

Should repairs still be necessary, please contact your KERN dealer or our Technical Department.

2 Nomenclature

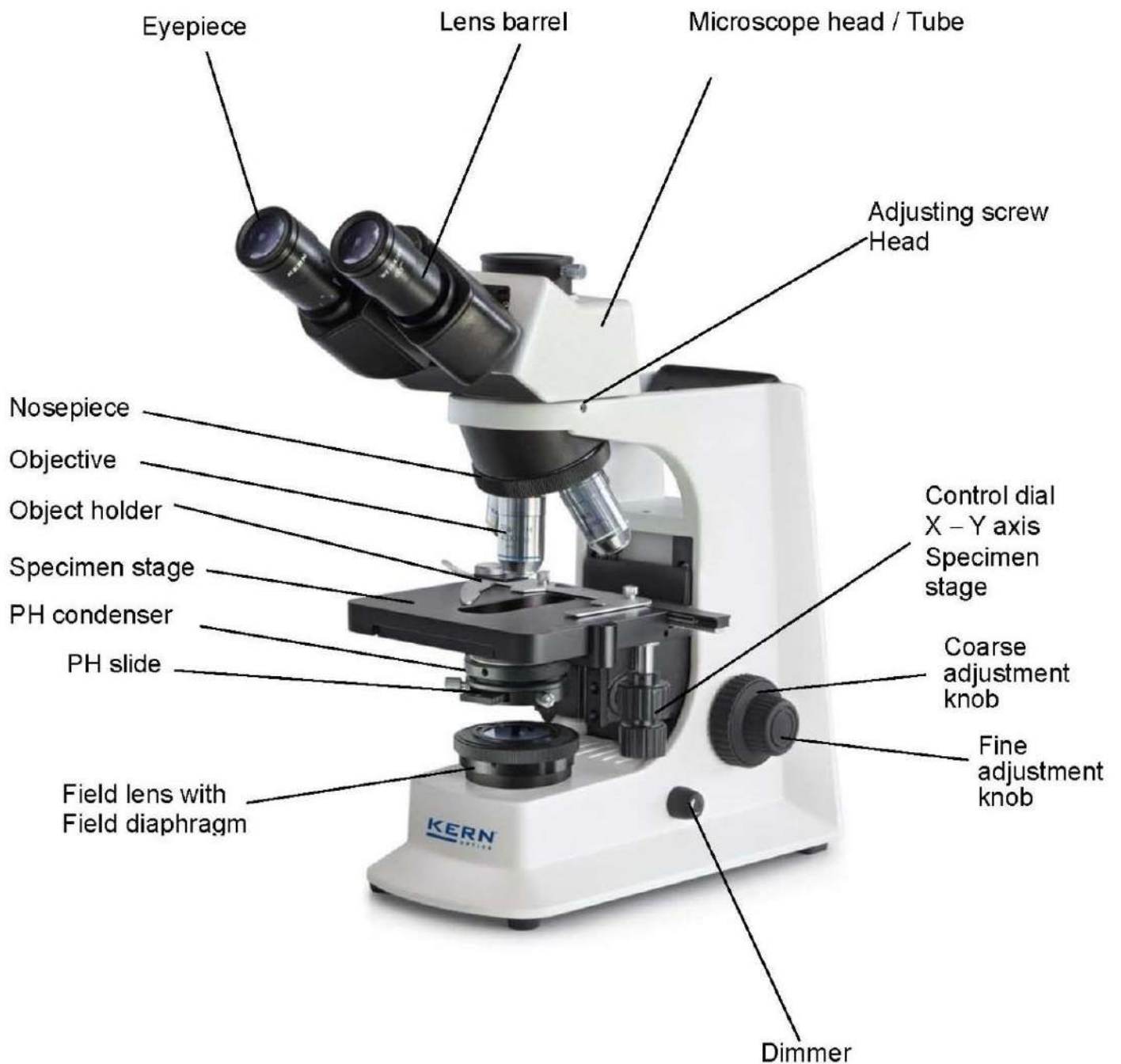

Rear view

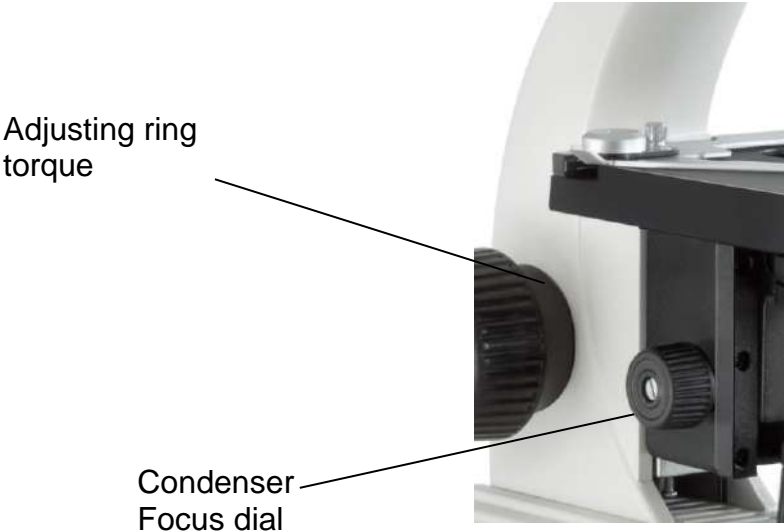
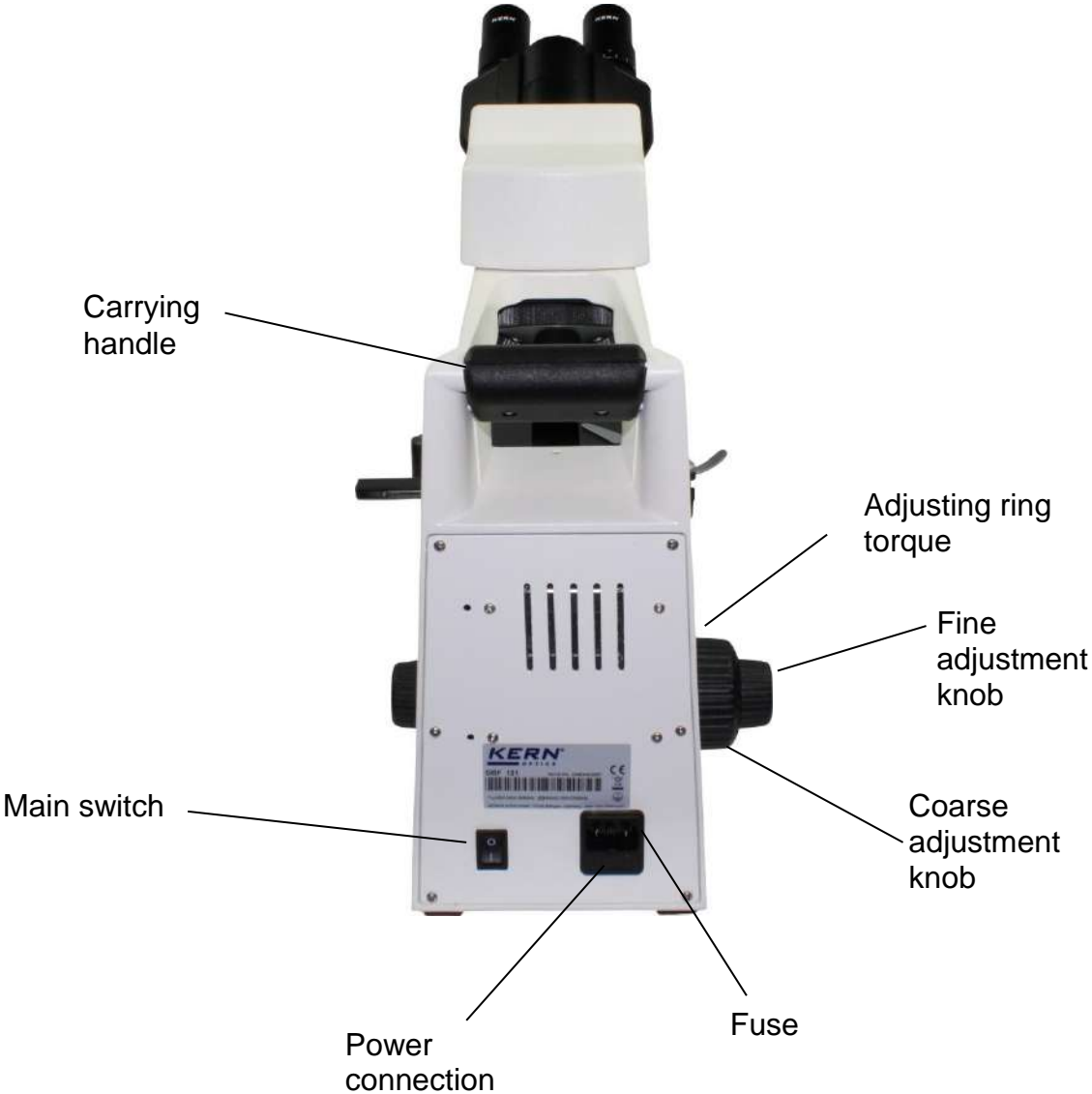

3 Technical data / Features

Model	Standard configuration		
	Optical system	Tube	Illumination
KERN			
OBL 145	Infinity	Binocular	6V / 20W Halogen (Transmitted light)
OBL 155	Infinity	Trinocular	6V / 20W Halogen (Transmitted light)

Eyepieces	WF 10x / Ø 20 mm
Objectives:	4x / PH10x / PH40x / 100x
Product dimensions:	395x200x380 mm
Packaging dimensions:	400x280x435 mm
Net weight:	6,7 kg
Gross weight:	8 kg
Input voltage:	AC 100-240V, 50-60Hz
Output voltage:	DC 1,2-6V
Fuse:	2A 5x20mm

Model outfit		Model KERN		Order number
		OBL 145	OBL 155	
Eyepieces	WF 10x / Ø 20 mm	●●	●●	OBB-A1351
	WF 16x / Ø 13 mm	○○	○○	OBB-A1354
	WF 10x / Ø 20 mm (reticule 0,1 mm) (adjustable)	○	○	OBB-A1352
Infinity E-Plan objectives	4x / 0,10	●	●	OBB-A1161
	10x / 0,25	○	○	OBB-A1159
	40x / 0,65 (spring)	○	○	OBB-A1160
	100x / 1,25 (oil) (spring)	●	●	OBB-A1158
	Plan 20x / 0,40	○	○	OBB-A1250
	Plan 60x / 0,85 (spring)	○	○	OBB-A1270
Binocular tube	<ul style="list-style-type: none"> • Siedentopf, 30° inclined, 360° rotatable • Interpupillary distance: 50 - 75 mm (for infinity system) • With diopter adjustment (one-sided) 	●	○	OBB-A1130
Trinocular tube	<ul style="list-style-type: none"> • Siedentopf, 30° inclined, 360° rotatable • Interpupillary distance: 50 - 75 mm • Light distribution: 20:80 (for infinity system) • With diopter adjustment (one-sided) 	○	●	OBB-A1346
Nosepiece	Quadplex	●	●	
Mechanical stage	<ul style="list-style-type: none"> • Stage size: WxD 145x130 mm • Travel: 76x52 mm • Coaxial coarse and fine focusing knobs, scale: 2 µm • Two slide holder 	●	●	
PH Condenser	Abbe N.A. 1,25 precentered, for bright field and phase contrast	●	●	OBB-A1398
Phase contrast unit	Infinity PH-Plan objective 10x	●	●	OBB-A1390
	Infinity PH-Plan objective 20x	○	○	OBB-A1391
	Infinity PH-Plan objective 40x	●	●	OBB-A1392
	Infinity PH-Plan objective 100x	○	○	OBB-A1393
	PH slide 10x	●	●	OBB-A1399
	PH slide 20x	○	○	OBB-A1400
	PH slide 40x	●	●	OBB-A1401
	PH slide 100x	○	○	OBB-A1402
	Centring telescope	●	●	
Dark field condenser	N.A. 0,85-0,91 (Dry)	○	○	OBB-A1422
Illumination	6V / 20W Halogen spare bulb (transmitting)	●	●	OBB-A1370
Field diaphragm	Field diaphragm	●	●	
Colour filter for transmitted illumination	Blue (built in)	●	●	
	Green	○	○	OBB-A1188
	Yellow	○	○	OBB-A1165
	Grey	○	○	OBB-A1183
C-Mount	0,47x (focus adjustable)		○	OBB-A1135
	1x		○	OBB-A1142

● = Standard configuration

○ = Option

4 Assembly

4.1 Microscope head

Inside the packaging the microscope head is already mounted but inclined towards the rear. In order to turn it to the front you must loosen the fixing screw on the tube connection point and after the turning fix it again with the screw. In case of removing the head completely from the housing, you should always make sure that you do not touch the lenses with your bare fingers and that no dust enters the apertures.

4.2 Objectives

The standard equipment of the series OBL-14 and OBL-15 includes two Infintiy E-Plan objectives (4x / 100x) and two Infinity Plan objectives for phase contrast applications (10x / 40x). All four objectives are already mounted to the nosepiece. After removing the protective foil they are ready for use. They are ranged in such a way that if you turn the nosepiece clockwise, the objective with the next higher magnification appears. When the objectives need to be dismantled, you should always make sure that you do not touch the lenses with your bare fingers and that no dust enters the apertures.

For objectives which are marked "OIL", you must use an immersion oil with the lowest level of inherent fluorescence.

4.3 Eyepieces

You must always use eyepieces with the same magnification for both eyes. These are simply placed onto the tube connectors, once you have first removed the plastic protective caps. There is no way of fixing them. You should always make sure that you do not touch the lenses with your bare fingers and that no dust enters the apertures.

4.4 Colour filter

A blue colour filter is already an integral part of the microscopes of the series OBL-14 and OBL-15. It is fitted underneath the field diaphragm. In order to use suitable filters, these can simply be placed in the ring bracket of the field lens.

4.5 PH condenser + PH slide

The condenser is firmly fixed onto a holding ring (condenser holder) underneath the microscope stage. There is the ability to adjust the height of the condenser, but not to centre it.

We recommend that you use the coarse adjustment knob to bring the specimen stage to its uppermost position when you need to remove the condenser. Then use the focus dial of the condenser to move the condenser holder to a low position. In this way the condenser can be taken off after loosening the screw on the left side holding ring. You should avoid touching the optical lenses with bare fingers.

To attach a PH slide for phase contrast applications, it just has to be inserted into the appropriate point on the front side of the condenser.

For further information on this please see 5.9 Phase contrast unit.

5 Operation

5.1 Getting started

The very first step is to establish a power connection using the mains plug. You should first adjust the **dimmer** to a **low level**, so that when you look through the eyepiece for the first time, your eyes are not immediately subject to a high level of light. You can now switch on the **lighting** using the **main switch**.

The next step is to **place an object holder** with the sample on the angle table. To do this, the cover glass must be facing upwards. You can fix the object holder to the table using the slide holder (*see illustration on the left*). To move the sample into the beam path, you must use the adjustment wheels on the right of the angle table (*see illustration on the right*).

You can position a total of two object holders at the same time.

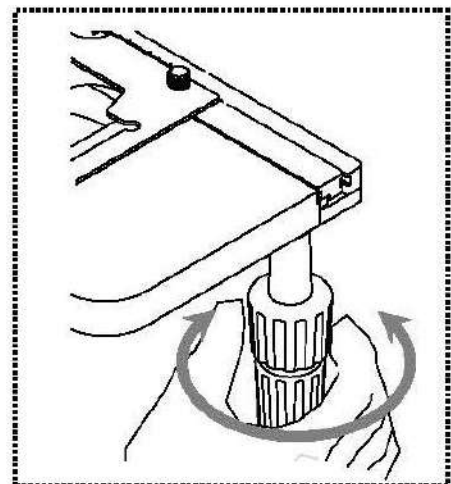
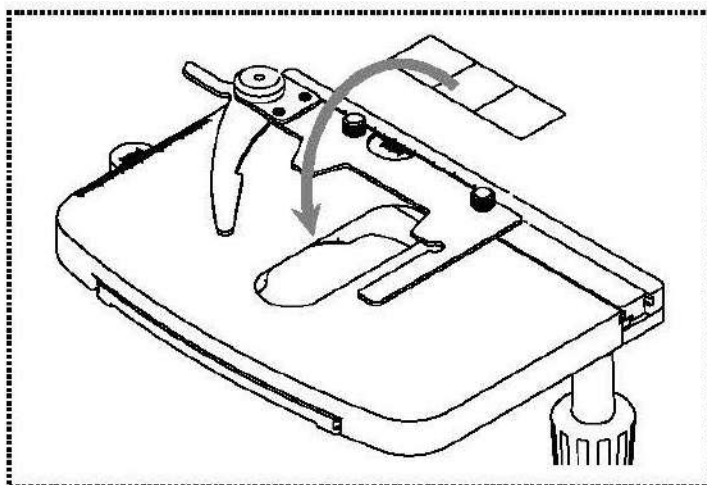

5.2 (Pre-) focussing

When you are observing an object, you must have the correct distance to the objective to achieve a sharp image.

In order to find this distance at the beginning (without other default settings of the microscope) place the objective with the lowest magnification in the beam path, look through the right eyepiece with the right eye and turn it slowly using the coarse adjustment knob (*see illustration*).

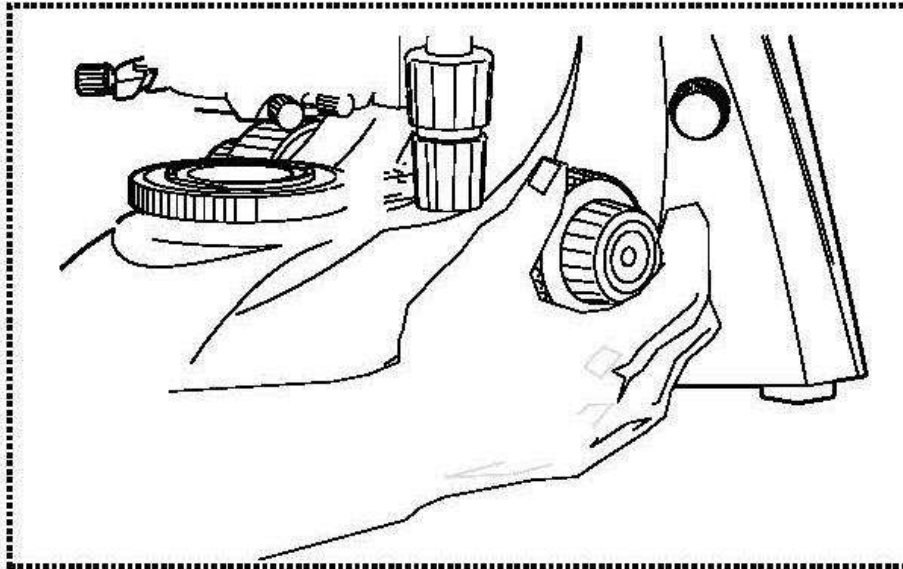

The simplest way of doing this would be to first raise the specimen stage (using the coarse adjustment knob) until it is just under the objective and then lower it slowly. As soon as an image is recognisable (no matter how sharp), then you should only adjust the focus using the fine adjustment knob.

Adjusting the torque of the coarse and fine adjustment knob

Next to the left adjustment wheel for the coarse and fine adjustment knob there is a ring which you can use to alter the torque of these wheels. Turning it in a clockwise direction reduces the torque and turning it in an anti-clockwise direction increases it. On one hand, this function can help to make it easier to adjust the focus and on the other hand it can prevent the specimen stage from slipping down unintentionally.

Important:

In order to avoid damaging to the focussing system, the left and right adjustment wheels for the coarse and fine adjustment knob must never be rotated at the same time in opposite directions.

5.3 Adjusting the interpupillary distance

With binocular viewing, the interpupillary distance must be adjusted accurately for each user, in order to achieve a clear image of the object.

While you are looking through the eyepieces, use your hands to hold the righthand and lefthand tube housing firmly. By pulling them apart or pushing them together, you can either increase or reduce the interpupillary distance (*see illustration*). As soon as the field of views of the lefthand and righthand eyepieces completely overlap each other, i.e. they combine to form a circular image, then the interpupillary distance is set correctly.

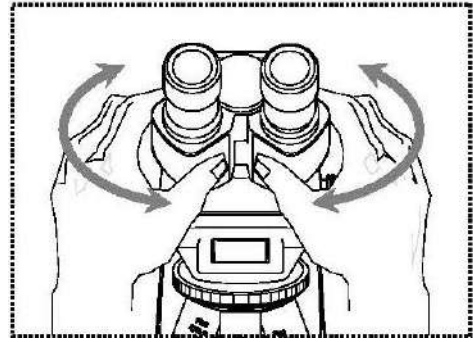

5.4 Dioptre adjustment

The eye strengths of each eye of the microscope user can often be slightly different, which in daily life has no consequences. But when using a microscope this can cause problems in achieving precise focussing.

You can use a mechanism on the left tube connector (dioptre adjustment ring) to compensate for this as follows.

1. Look through the right eyepiece with the right eye and bring the object into focus by using the coarse and fine adjustment knob.
2. Then look through the left eyepiece with the left eye and use the dioptre adjustment ring to focus the image.
To do this, you just need to turn the ring in both directions (*see illustration*), to find out where the image is at its most focussed.

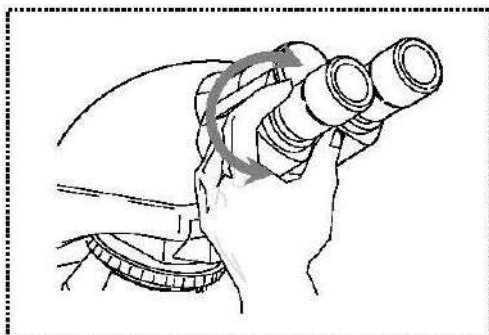

5.5 Adjusting the magnification

After prefocussing has been carried out using the objective with the lowest magnification (see section 5.2), you can then adjust the overall magnification using the nosepiece, as necessary. By turning the nosepiece you can bring any one of the four other objectives into the beam path.

When adjusting the nosepiece, you must take the following points into account:

- The required objective must be properly locked in place at all times.
- The nosepiece should not be rotated by holding individual objectives, you should use the silver ring above the objectives (see illustration).
- When rotating the nosepiece you must always make sure that the objective which is about to be positioned in the beam path does not touch the object holder. This can lead to significant damage to the objective lens. We recommend that you always check from the side to make sure that there is sufficient leeway. If this should not be the case, the specimen stage must be lowered accordingly.

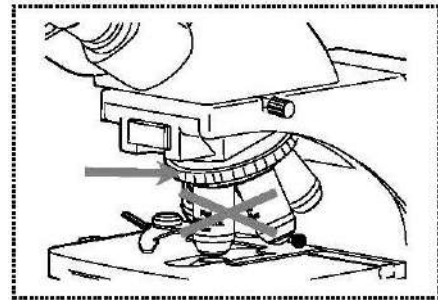

If you have focussed the object to be observed for a specific magnification, then if you select the objective with the next greatest magnification, then the object will be slightly out of focus. Use the fine adjustment knob to make a slight adjustment and restore the focus.

5.6 Adjusting the Koehler illumination

To make sure that perfect image results are achieved during microscopic observation, it is important that the direction of light of the microscope is optimised. If, as with the devices in the KERN OBL-14 and OBL-15 series, the lighting can be set in accordance with Koehler, the result is homogenous illumination of the slide and avoidance of disruptive stray light.

The necessary control elements for this are:

- Height-adjustable and centre-adjustable condenser with aperture diaphragm
- Field diaphragm

Note: The condenser of the microscopes of the series OBL-14 and OBL-15 is not centre-adjustable. Therefore it is not a full Koehler illumination. However this is regarded as Fixed-Koehler, since the condenser is pre-centred.

When adjusting the Koehler lighting for the first time, you must first select the lowest possible objective magnification, so that you can carry out the following steps.

1. Use the condenser focus wheel to position the condenser directly below the specimen stage. Switch on the lighting and use the coarse and fine adjustment knob to bring the slide with the cover glass positioned facing upwards into focus.

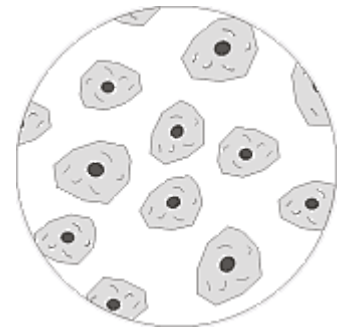

2. Close the field diaphragm completely using its adjusting ring. When you look in the microscope a blurred image appears in the aperture.



3. Adjust the height of the condenser until the image from the field diaphragm appears clearly in the field of view. For some microscopes there is a risk that you will lift the condenser up so high that it collides with the object holder. Therefore care is needed when doing this.



4. Open the field diaphragm until it just disappears out of the field of view.
If necessary, simply re-centre using the centring screws on the condenser holder.

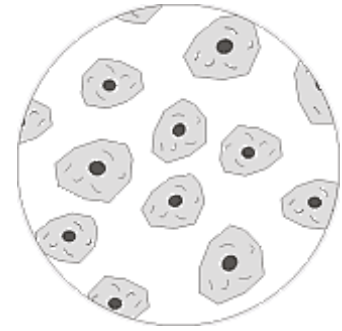

5. Use the aperture diaphragm of the condenser to find the very best compromise between contrast and resolution for the microscopic image. The scale divisions on the condenser can be used as a guideline. Select in accordance with the objective being used.

The view in the tube without the eyepiece should look something like the illustration on the right.

The diameter of the aperture diaphragm which is then visible should make up approximately $\frac{2}{3}$ of the pupil diameter.

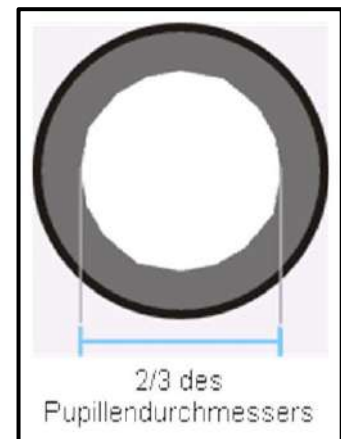

If the eyepiece should be removed, for checking, then please make sure that no dirt or dust falls into the tube.

6. It is possible to alter the brightness of the bulb using the **dimmer**. The brightness is always controlled by the bulb brightness and not by the aperture diaphragm.
7. Possibly there is the need of re-adjusting the focus and x-y axis.
8. Observe the object.

If another magnification is selected afterwards, then the Koehler illumination does not have to be reset from scratch, only the aperture diaphragm and field diaphragm need to be adjusted as required.

5.7 Using eye cups

The eye cups supplied with the microscope can basically be used at all times, as they screen out intrusive light, which is reflected from light sources from the environment onto the eyepiece, and the result is better image quality.

But primarily, if eyepieces with a high eye point (particularly suitable for those who wear glasses) are used, then it may also be useful for users who don't wear glasses, to fit the eye cups to the eyepieces.

These special eyepieces are also called High Eye Point eyepieces. They can be identified by the glasses symbol on the side. They are also marked in the item description by an additional "H" (example: HSWF 10x Ø 23 mm).

When fitting the eye cups, make sure that the dioptre setting is not moved. We would therefore advise that you hold the dioptre compensation ring on an eyepiece with one hand while you fit the eye cup with the other.

Before using the microscope, users who wear glasses must remove the eye cups, which you may find on High Eye Point eyepieces.

As the eye cups are made of rubber, you must be aware that when you are using them, they can become slightly dirty through grease residues. In order to maintain hygiene, we would therefore recommend that you clean the eye cups regularly (e.g. with a damp cloth).



Eye cups



High Eye Point eyepiece
(identified by the glasses symbol)

5.8 Using oil immersion objectives

The 100x objectives of the OBL-14 and OBL-15 series are objectives which can be used with oil immersion (they are always marked with the word "OIL"). Using these generates a particularly high resolution for microscopic images.

To use oil immersion correctly, please follow these steps.

1. Put a drop of oil on the cover glass (with standard thickness of 0.17 mm) of the object slide.
2. Lower the specimen stage and position the 100x objective in the beam path.
3. Bring the specimen stage or object slide to the objective very slowly until there is slight contact.
4. Observe the object.

The object slide and objective must not be pressed against each other. The oil constitutes the contact layer.

If the contact is made too jerky, there is a chance that existing air bubbles in the oil cannot escape. This would have a negative impact on image clarity.

After use or before changing the slide, any components which have been in contact with the oil must be cleaned thoroughly. *See also 1.4 Maintenance and cleaning.*

5.9 Phase contrast unit

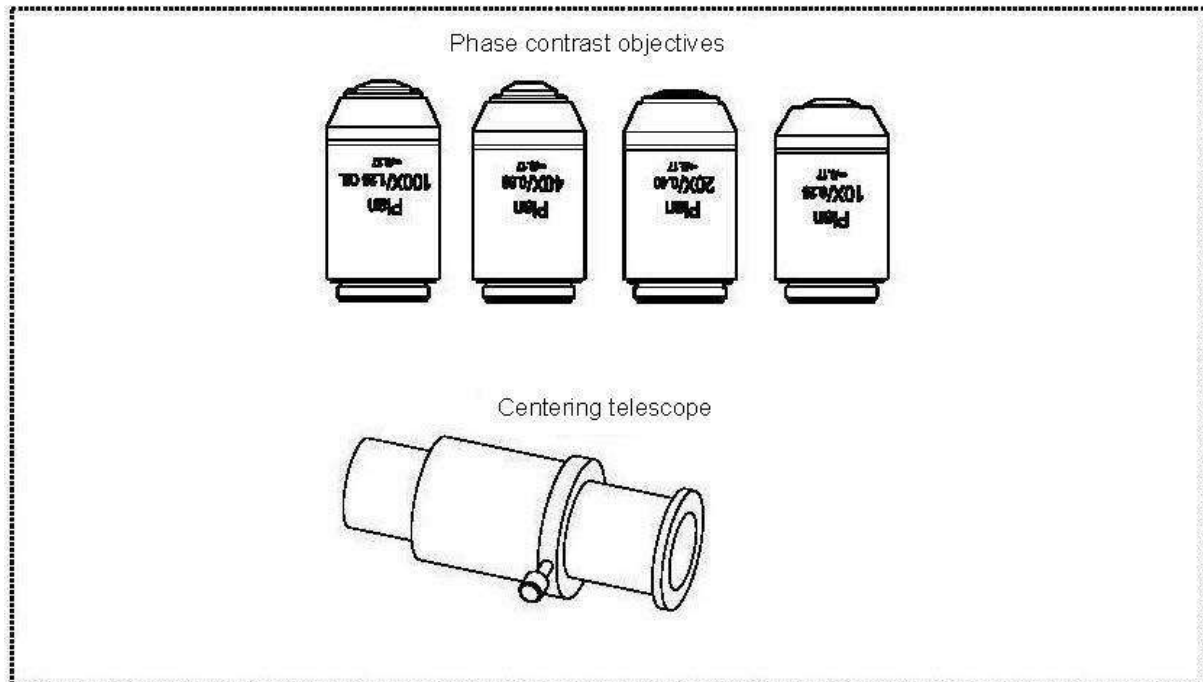

Simple phase-contrast unit

This consists of a simple PH condenser, a PH objective with a specific magnification (10x, 20x, 40x or 100x), a PH slider, which is adapted to the lens being used, a centring telescope and a green filter.

The standard outfit of the models of the series OBL-14 and OBL-15 always includes a 10x and 40x phase contrast unit.

To use this, you need to position the desired PH objective in the beam path and furthermore to place the corresponding PH slide into the insertion point of the PH condenser.

With the surface marked with the magnification information facing up, the PH slider is pushed into the insertion point on the PH condenser until stop. At this position the phase ring of the PH slider is in the beam path and the phase-contrast application can begin. In order to return to the bright field application, you must pull the PH slider out of the condenser, so that the beam can pass the condenser without being affected by the PH slider.

The PH objective has a PH ring in its lens system, just like the PH slider. Due to their size on one hand and their positioning on the other, these two rings must be aligned to one another in the beam path. The position of the ring in the objective cannot be altered, that of the ring in the slider however can be. Before starting the phase-contrast application you have to check if this alignment is given. For this you must install the centring telescope to the tube connector instead of a standard eye piece and look through it (*The appearing image can be focussed by firstly loosening the locking screw on the centring telescope, pull out the front part of the centring telescope to the correct position and finally retightening the locking screw*).

When installing the centring telescope instead of one of the eyepieces there is appearing an image of a white (slide) and a black (objective) ring in the field of view (*see illustration*). The black one is located centrally and the white one possibly shifted to the side. In case of a shift, the position of the white ring has to be adjusted in order to effect an exact overlapping of both rings by means of the two adjusting screws of the condenser.

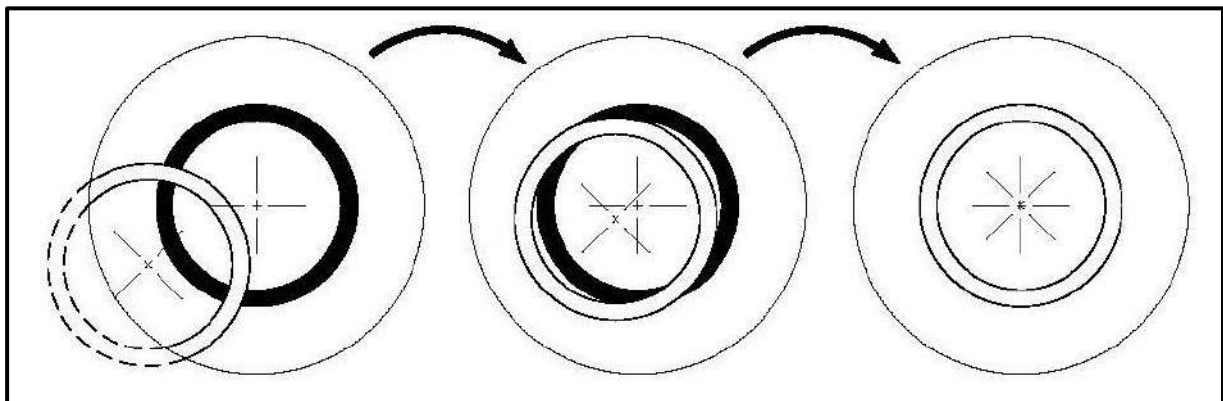

Depending on the preferences of the user, using a green filter can produce a more effective and pleasant image. To achieve this, the green filter must be placed in the ring bracket of the field lens.

6 Changing the bulb

Halogen

You must not attempt to change the bulb immediately after the microscope has been used, as the bulb will still be hot and so there is a risk that the user could be burnt. Before changing the bulb the device must be switched off and unplugged.

To change the bulb, tip the device carefully to the back or side. When doing this, please make sure that all microscope components are firmly fixed. The bulb holder is on the underside of the device. It can be opened by undoing the screws on the holder (see *left illustration*). We recommend that here you should also test again, to check that heat is no longer being produced. The defective bulb can be pulled out of the socket and be replaced with a new one. After the bulb holder has been replaced in the underside of the device and the screws replaced, the bulb replacement procedure is complete.

Important:

When fitting the new bulb into the socket, it must only be handled with sterile gloves or using the bulb packaging film. Grease and dust residue can have a negative effect on the light quality and service life.

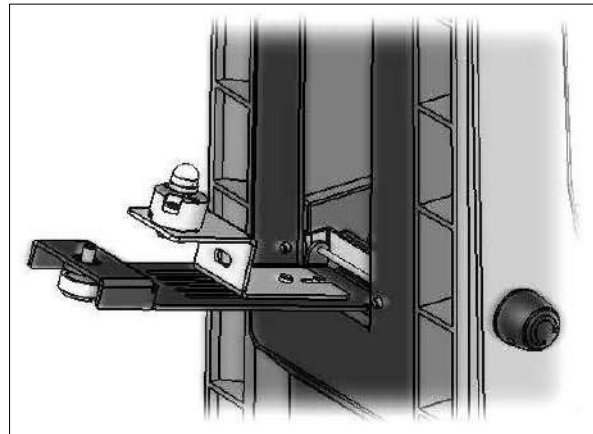
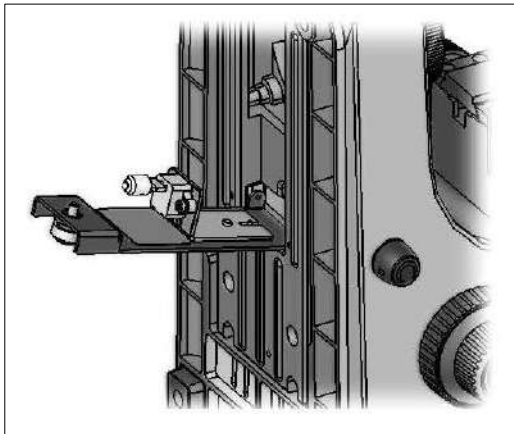

7 Changing the fuse

The fuse housing is on the rear of the microscope below the mains power supply socket. With the device switched off and unplugged, you can pull out the housing. When doing this, it is helpful to use a screwdriver or similar tool. The defective fuse can be removed from its housing and be replaced with a new one.

After that, you just need to insert the fuse housing back into the insertion point below the mains power supply socket.

8 Using optional accessories

8.1 Camera connection

OBL 155

Due to the trinocular tube, which is a standard fitting for the model OBL 155, it is possible to connect microscope cameras to the device, in order to digitally record images or sequences of images of an object being observed.

After the plastic cover has been removed from the camera adapter connector on the top of the microscope head, then a suitable adapter must be fitted.

In general there are two C-mount adapters available for this (1x and 0.47x magnification, *see Chapter 3 Features*). After fitting one of these adapters it can be fixed with the fixing screw. A camera which has a C-mount thread is then screwed on top of the adapter.

We recommend that you first adjust the field of view using the eyepieces on the device for the existing requirements, and then carry out the observation using the microscope camera (i.e. using the PC screen which is connected).

The tube has a light distribution that guarantees the providing of light for the eyepieces and the camera connection at the same time. This means that it is possible to simultaneously observe by the eyepieces and PC screen.

For C-mount adapters, which have their own integrated magnification, the image which is shown on the camera connected to the device can often have a different level of focus compared with the image on the eyepiece.

In order to be able to bring both images into focus, the focus can be adjusted by those adapters.

9 Trouble shooting

Problem	Possible causes
The bulb does not light	The mains plug is not correctly plugged in
	There is no power at the socket
	Defective bulb
	Defective fuse
The bulb blows immediately	The specified bulb or fuse has not been used
The field of view is dark	The aperture diaphragm and/or field diaphragm are not opened wide enough
	The selector switch for the beam path is set to "Camera"
	The condenser is not correctly centred
You cannot adjust the brightness	The brightness control has been set incorrectly
	The condenser has not been correctly centred
	The condenser is too low
The field of view is dark or is not correctly illuminated	The objective is not positioned correctly on the beam path
	The selector switch for the beam path is between two settings
	The nosepiece is not correctly fitted
	The condenser is not correctly fitted
	An objective is being used which doesn't match the lighting area of the condenser
	The condenser has not been correctly centred
	The field diaphragm is closed too tightly
	The bulb is not correctly fitted
The field of view of one eye does not match that of the other eye	The interpupillary distance is not correctly adjusted
	Dioptre setting has not been carried out correctly
	Different eyepieces are used for the righthand and lefthand side
	The eyes are not used to using a microscope

Problem	Possible causes
Blurred details Bad image Bad contrast Vignetted field of view	The aperture diaphragm is not opened wide enough
	The condenser is too low
	The objective does not belong to this microscope
	The front lens of the objective is dirty
	An immersion object has been used without immersion oil
	The immersion oil contains air bubbles
	The condenser is not correctly centred
	The recommended immersion oil has not been used
Dirt or dust in the field of view	Dirt / dust on the objective
	Dirt /dust on the front lens of the condenser
	Dirt / dust on the eyepieces
One side of the image is blurred	Dirt / dust on the front lens of the condenser
	Dirt / dust on the object
	The stage was not correctly fitted
	The objective is not positioned correctly on the beam path
The image flickers	The nosepiece is not correctly fitted
	The objective is not positioned correctly on the beam path
	The condenser has not been correctly centred
The coarse adjustment knob is difficult to turn	The rotational resistance brake is too tight
	The angle table is blocked by a solid body
The stage moves down on its own The fine adjustment knob moves on its own	The rotational resistance brake is not tight enough
When you move the table, the image becomes blurred	The stage was not correctly fitted

10 Service

If, after studying the user manual, you still have questions about commissioning or using the microscope, or if unforeseen problems should arise, please get in touch with your dealer. The device may only be opened by trained service engineers who have been authorised by KERN.

11 Disposal

The packaging is made of environmentally-friendly materials, which you can dispose of at your local recycling centre. Disposal of the storage box and device must be carried out by the operator in accordance with all national or regional laws in force in the location of use.

12 Further information

The illustrations may differ slightly from the product.

The descriptions and illustrations in this user manual are subject to change without notice. Further developments on the device may lead to these changes.



All language versions contain a non-binding translation.
The original German document is the binding version.

