



**KERN & Sohn GmbH**

Ziegelei 1

D-72336 Balingen

E-Mail: [info@kern-sohn.com](mailto:info@kern-sohn.com)

Tel: +49-[0]7433- 9933-0

Fax: +49-[0]7433-9933-149

Internet: [www.kern-sohn.com](http://www.kern-sohn.com)

# Service Manual Wheelchair scale

## KERN MWB

Version 1.0

03/2018

GB

Importør:

Impex Produkter AS

Gamle Drammensvei 107

1363 Høvik

[www.impex.no](http://www.impex.no)

[info@impex.no](mailto:info@impex.no)

Tel.: 22 32 77 20



MWB-SH-e-1810



# KERN MWB

## Wheelchair scale

Version 1.0 04/2018  
Service manual

### Content

<b>1</b>	<b>Basic Information</b>	<b>4</b>
<b>2</b>	<b>Introduction</b>	<b>4</b>
<b>3</b>	<b>Appliance overview</b>	<b>5</b>
3.1	Details	6
3.2	Overview display	7
3.3	Overview Keyboard	8
<b>4</b>	<b>Basic Information (General)</b>	<b>9</b>
4.1	Proper use	9
4.2	Improper Use	9
4.3	Warranty	9
4.4	Monitoring of Test Resources	9
<b>5</b>	<b>Basic Safety Precautions</b>	<b>10</b>
5.1	Pay attention to the instructions in the Operation Manual	10
<b>6</b>	<b>Transport and storage</b>	<b>10</b>
6.1	Testing upon acceptance	10
6.2	Packaging / return transport	10
<b>7</b>	<b>Unpacking, Setup and Commissioning</b>	<b>11</b>
7.1	Place of installation / place of operation	11
7.2	Unpacking	11
7.3	Scope of delivery	11
7.4	Levelling	11
<b>8</b>	<b>Menu</b>	<b>12</b>
8.1	Navigation in the menu	12
8.2	Menu overview	12
<b>9</b>	<b>Error Messages</b>	<b>14</b>
<b>10</b>	<b>Servicing, maintenance, disposal</b>	<b>15</b>
10.1	Cleaning	15
10.2	Cleaning / disinfecting	15
10.3	Servicing, maintenance	15
10.4	Disposal	15
<b>11</b>	<b>Instant help</b>	<b>15</b>
<b>12</b>	<b>Adjustment</b>	<b>17</b>
<b>13</b>	<b>MAINTENANCE</b>	<b>18</b>
13.1	General	18
13.2	Cleaning	18
13.3	Determine the Problem	18
13.4	Check the Load cell	18

13.5 Load Cell Connections.....19  
13.6 Check PCB Voltages .....20  
13.7 PCB Input Voltage .....20  
13.8 Check Battery Voltage.....20  
13.9 Replace Main Board .....21  
13.10 Replace Battery .....21  
14 Drawing..... 22  
15 Schematic..... 23

## 1 Basic Information

The device must be repaired only by trained specialist staff or personnel with professional formation (such as a repair-specialist accredited by law concerning verification). The service manual is obligatory for repair work. After repair, original conditions of the device have to be restored. Only original spare parts should be used.

### **Instructions about conformity-evaluated scales:**

Repair must be carried only at 100% compliance with the type approval. A violation of this specification will result in a loss of the type approval! After successful repair the balance will have to be reverified before it can be used again in a statutorily regulated field.

### **Detailed instructions about conformity-evaluated scales:**

Repair must be carried only at 100% compliance with the type approval. A violation of this specification will result in a loss of the type approval!

After successful repair the balance will have to be reverified before it can be used again in a statutorily regulated field.

## 2 Introduction

This service manual covers the MWB series and is edited for the authorized servicing personnel.

Note all rights are reserved. Copying any part of this manual is prohibited without our permission.

In this lineup it is an eco product, Therefore, it is not intended to represent the repair manual in detail, since the construction of the balance is very simple. It is therefore only referring to the list of related to disposal spare parts.

### 3 Appliance overview

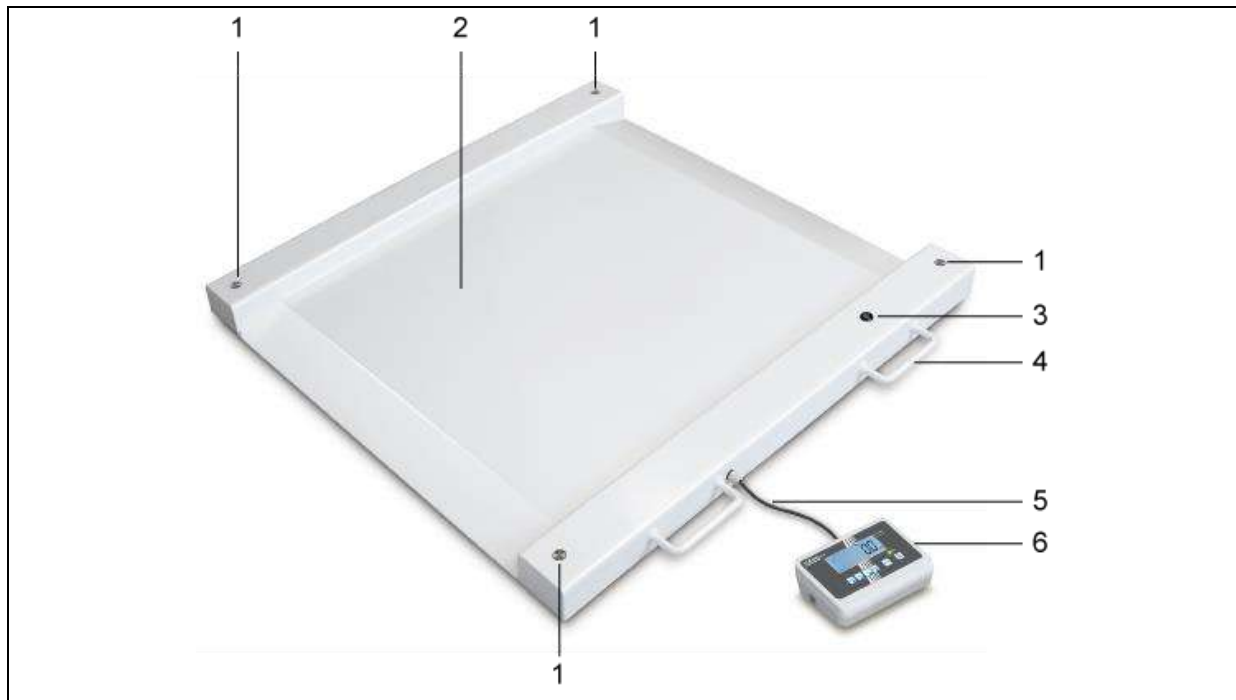

1. Cover of weighing cell feet
2. Weighing surface
3. Bubble level
4. Hand grip
5. Connection cable
6. Display Unit



Bubble level and handle (2x)





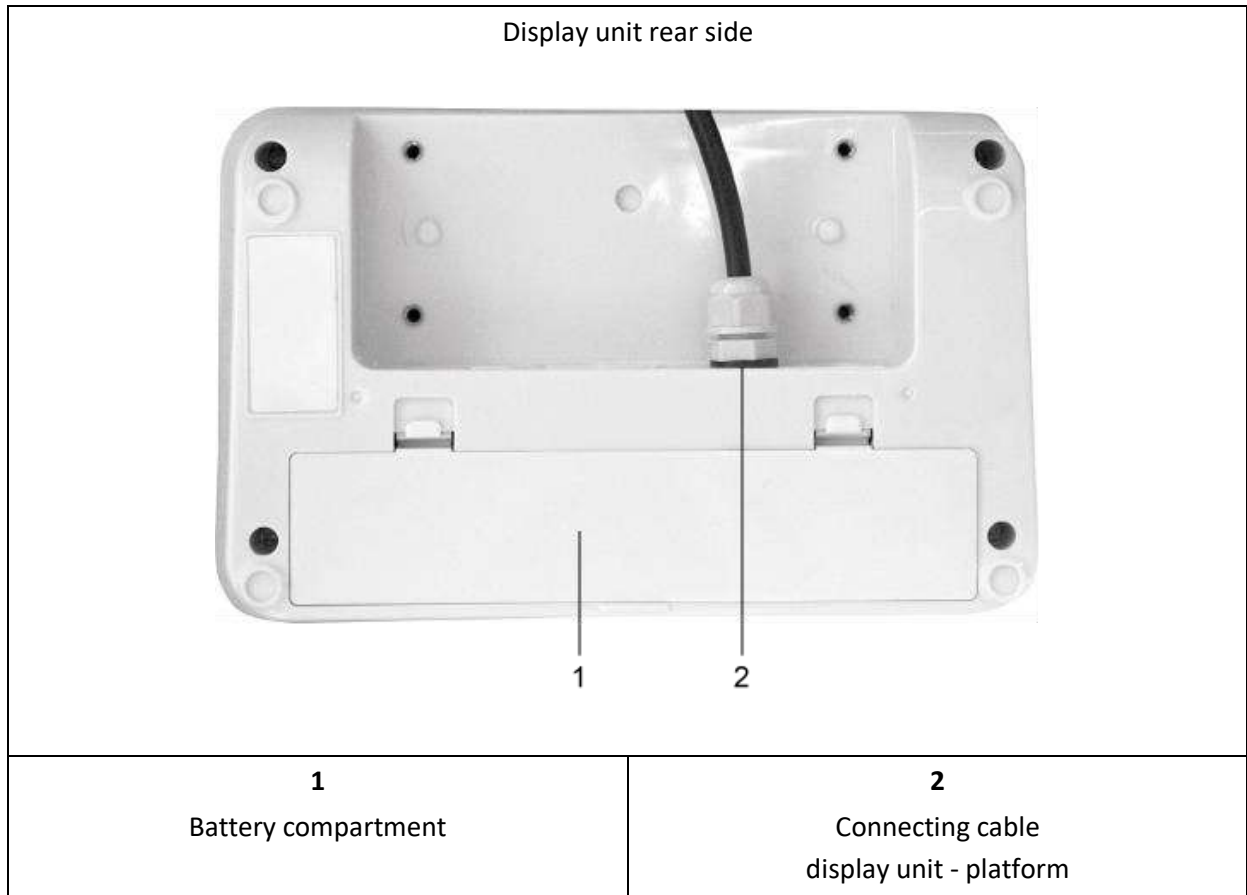

Conveyor roller (2x)

### 3.1 Details

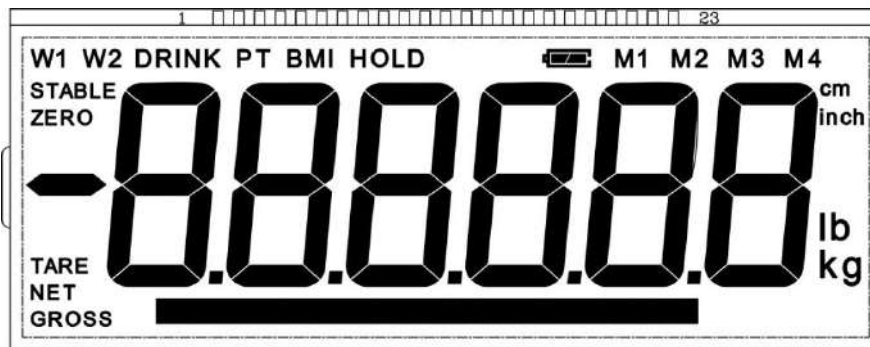







### 3.2 Overview display

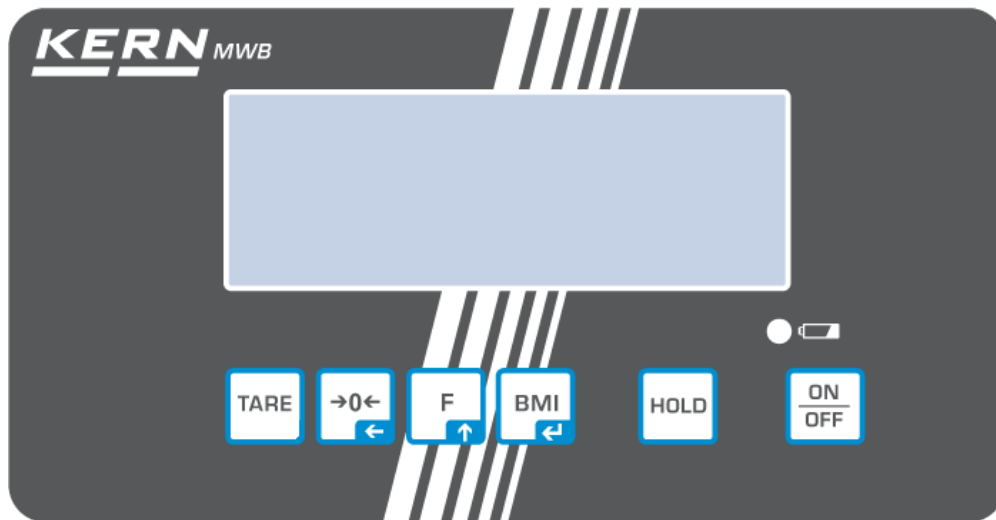

Display	Designation	Description
<b>GROSS</b>	Gross weight display	Lights up during indication of the gross weight
<b>NET</b>	Net weight display	Lights up during indication of the net weight Illuminated after weighing scale was tared
<b>ZERO</b>	Zeroing display	Should the balance not display exactly zero despite empty scale pan, press the button. Your balance will be set to zero after a short standby time.
<b>STABLE</b>	Stability display	Scales are in a steady state
<b>BMI</b>	Body Mass Index	Is actively displayed during active BMI function
<b>HOLD</b>	HOLD function	Is displayed with active hold function
		Lights when the voltage drops below the prescribed minimum.
	Battery symbol	Lights when the battery capacity is almost exhausted.
		Lights when the battery is fully charged.

### 3.3 Overview Keyboard



Button	Designation	Function
	ON/OFF button	Turn on/off
	<b>HOLD</b> button	Hold function
	BMI key	Calculation of the Body Mass Index <b>In menu:</b> <ul style="list-style-type: none"> <li>• Confirm selection</li> </ul> <b>For numeric entry:</b> <ul style="list-style-type: none"> <li>• Confirm numerical value</li> </ul>
	Function key	<b>In menu:</b> <ul style="list-style-type: none"> <li>• Call up menu</li> <li>• Select menu items</li> </ul> <b>For numeric entry:</b> <ul style="list-style-type: none"> <li>• Increase numerical value</li> </ul>
	Zero setting key	Weighing scale will be reset to „0.0“ <b>For numeric entry:</b> <ul style="list-style-type: none"> <li>• Change decimal place</li> </ul>
	TARE key	Tare balance



## **4 Basic Information (General)**

### **4.1 Proper use**

This weighing scale is designed for determining the weight of a person whilst standing or sitting.

On multifunctional weighing scales, the weighed person should carefully step onto the center of the weighing platform and remain standing without moving. If weighed with a wheelchair, the wheelchair should remain in the center of the weighing plate.

As soon as a stable weighing value is reached the weighing value can be read.

The weighing scale is designed for continuous duty.

### **4.2 Improper Use**

Do not use these scales for dynamic weighing processes.

Do not leave permanent load on the weighing plate. This may damage the measuring system.

Impacts and overloading exceeding the stated maximum load (max) of the weighing plate, minus a possibly existing tare load, must be strictly avoided. This could cause damage to the balance.

Never operate balance in explosive environment. The serial version is not explosion protected. It should be noted that a flammable mixture of anesthetics and oxygen or laughing gas may occur.

The structure of the balance may not be modified. This may lead to incorrect weighing results, safety-related faults and destruction of the balance.

The balance may only be used according to the described conditions. Other areas of use must be released by KERN in writing.

The balance cannot be used to determine a body weight in practice of medicine.

### **4.3 Warranty**

Warranty claims shall be voided in case

- Our conditions in the operation manual are ignored
- The appliance is used outside the described uses
- Modification or opening of appliances
- Mechanical damage and damage caused by media, liquids,
- Natural wear and tear
- The appliance is improperly set up or incorrectly electrically connected
- The measuring system is overloaded
- Dropping of scales

### **4.4 Monitoring of Test Resources**

In the framework of quality assurance the measuring-related weighing properties of the balances and, if applicable, the testing weight, must be checked regularly. The responsible user must define a suitable interval as well as type and scope of this test. Information is available on KERN's home page ([www.kern-sohn.com](http://www.kern-sohn.com)) with regard to the monitoring of balance test substances and the test weights required for this. In KERN's accredited DKD calibration laboratory test weights and balances may be calibrated (return to the national standard) fast and at moderate cost.

## 5 Basic Safety Precautions

---

### 5.1 Pay attention to the instructions in the Operation Manual

	⇒ Carefully read this operation manual before setup and commissioning, even if you are already familiar with KERN balances.	
---	---	--

---

## 6 Transport and storage

---

### 6.1 Testing upon acceptance

When receiving the appliance, please check packaging immediately, and the appliance itself when unpacking for possible visible damage.

### 6.2 Packaging / return transport



- ⇒ Keep all parts of the original packaging for a possibly required return.
- ⇒ Only use original packaging for returning.
- ⇒ Prior to dispatch disconnect all cables and remove loose/mobile parts.
- ⇒ Reattach possibly supplied transport securing devices.
- ⇒ Secure all parts against shifting and damage.

---

## 7 Unpacking, Setup and Commissioning

---

### 7.1 Place of installation / place of operation

The balances are designed in a way that reliable weighing results are achieved in common conditions of use. You will work accurately and fast, if you select the right location for your balance.

#### On the installation site observe the following:

- Place scales on a stable, even surface
- Avoid extreme heat as well as temperature fluctuation caused by installing next to a radiator or in the direct sunlight;
- Protect the balance against direct draughts due to open windows and doors;
- Avoid jarring during weighing;
- Protect the balance against high humidity, vapours and dust;
- Do not expose the device to extreme dampness for longer periods of time. Non-permitted condensation (condensation of air humidity on the appliance) may occur if a cold appliance is taken to a considerably warmer environment. In this case, acclimatize the disconnected appliance for ca. 2 hours at room temperature.
- Avoid static charge of the balance and of the person to be weighed.
- Avoid contact with water.

Major display deviations (incorrect weighing results) may be experienced should electromagnetic fields (e.g. due to mobile phones or radio equipment), static electricity accumulations or instable power supply occur. In that case, the location must be changed.

### 7.2 Unpacking

Remove the individual components of the balance or the complete balance from the packaging with care and install at the intended location. When using the power pack, ensure that the power cable does not produce a risk of stumbling.

### 7.3 Scope of delivery

- Balance, completely assembled
- Operating manual



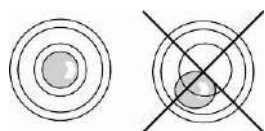



### 7.4 Levelling





- ⇒ Level balance with foot screws until the air bubble of the water balance is in the prescribed circle.
- ⇒ Check levelling regularly.

## 8 Menu

### 8.1 Navigation in the menu



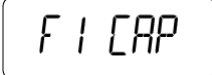

<b>Call up menu</b>	<p>⇒ In weighing mode, press  and the first function [F1 oFF] will be displayed.</p>
<b>Select function</b>	<p>⇒ With help of , the individual functions can be selected one after the other.</p>
<b>Change settings</b>	<p>⇒ Confirm selected function by . The current setting will be displayed.</p> <p>⇒ Select desired setting by  and confirm with , the balance returns to the menu.</p>
<b>Exit menu/ Return to weighing mode</b>	<p>⇒ Press , the balance will return to weighing mode.</p>

### 8.2 Menu overview

Function	Settings	Description
 Adjustment		Adjustment
	d 0, d 0.0, d 0.00, d 0.000, d 0.0000	Capacity
 Automatic cutout Auto Off	oFF 3 oFF 5 oFF 15	Automatic shutdown after 3 min. Automatic shutdown after 5 min. Automatic shutdown after 15 min.

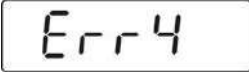
<p>F4 GRR</p> <p>Gravity</p>		Gravity
<p>F5 COM</p>	not documented	

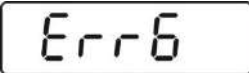
## 9 Error Messages

Display	Description
	<b>Zero range exceeded</b>  (on start-up or when pressing the  key) <ul style="list-style-type: none"><li>• Load on weighing pan</li><li>• Excess load, during zero setting of weighing scale</li><li>• Incorrect adjusting process</li><li>• Fault on load cell</li></ul>
	<b>Value outside the A/D converter range</b> <ul style="list-style-type: none"><li>• Damaged weighing cell</li><li>• Damaged electronics</li></ul>
	<b>Unable to initialize zero point</b> <ul style="list-style-type: none"><li>• Measuring cell defective / overloaded</li><li>• Object on weighing pan / contact</li><li>• Transport safety device has not been removed</li><li>• Main board defective</li></ul>
OL or -----	<b>Overload</b> <ul style="list-style-type: none"><li>• Unload, switch off and adjust the balance</li></ul>
-----or „0“	<b>Underload</b> <ul style="list-style-type: none"><li>• Unload, switch off and adjust the balance</li></ul>

Should other error messages occur, switch balance off and then on again. If the error message remains inform manufacturer.

## 10 Servicing, maintenance, disposal

### 10.1 Cleaning



Before any maintenance, cleaning and repair work disconnect the appliance from the operating voltage.

### 10.2 Cleaning / disinfecting

Clean weighing platform (such as seat pan) as well as casing with household detergents or commercially available disinfectants, e.g. 70% isopropanol. We recommend a disinfectant suitable for wiping disinfection. Please follow manufacturer's instructions.

Do not use abrasive or aggressive cleaners such as spirits or alcohol or similar as they might damage the high-quality surface.

### 10.3 Servicing, maintenance

The appliance may only be opened by trained service technicians who are authorized by KERN.

Disconnect the scales before opening.

### 10.4 Disposal

Disposal of packaging and appliance must be carried out by operator according to valid national or regional law of the location where the appliance is used.

## 11 Instant help

---

In case of a fault in the program sequence, the balance should be shortly switched off. The weighing process must then be restarted from the beginning.

#### Failure:

#### Possible causes:

The displayed weight does not glow.

- The balance is not switched on.
- The mains supply connection has been interrupted (mains cable not plugged in/faulty).
- Power supply interrupted.
- Battery inserted incorrectly or empty.
- No battery inserted.

The displayed weight is permanently changing

- Draught/air movement
- Table/floor vibrations
- The seating surface is in contact with foreign bodies or is not correctly positioned.
- Electromagnetic fields / static charging (choose different location/switch off interfering device if possible)

The weighing result is obviously incorrect

- The display of the balance is not at zero.
- Adjustment is no longer correct.
- Great fluctuations in temperature.
- The balance is on an uneven surface.
- Electromagnetic fields / static charging (choose different location/switch off interfering device if possible)

Should other error messages occur, switch balance off and then on again. If the error message remains inform manufacturer.



## 12 Adjustment

As the acceleration value due to gravity is not the same at every location on earth, each display unit with connected weighing plate must be coordinated - in compliance with the underlying physical weighing principle - to the existing acceleration due to gravity at its place of location (only if the weighing system has not already been adjusted to the location in the factory). This adjustment process must be carried out for the first commissioning, after each change of location as well as in case of fluctuating environment temperature. To receive accurate measuring values it is also recommended to adjust the display unit periodically in weighing operation.

<b>i</b>	<ul style="list-style-type: none"> <li>Prepare the required adjustment weight. The adjustment weight to be applied depends on the capacity of a weighing scale, see chap. 1. Carry out adjustment as closely as possible to admissible maximum load of weighing scale. Info about test weights can be found on the Internet at: <a href="http://www.kern-sohn.com">http://www.kern-sohn.com</a>.</li> <li>Observe stable environmental conditions. For warm-up time required for stabilization</li> </ul>
----------	---

### Procedure:

	⇒ Switch-on balance by  and during the selftest press . [FO CAL] is displayed.
	⇒ Press  , [CAL] will be displayed
	⇒ Press  again, [ULOAD] will be displayed.
	⇒ Wait for stability display, then press  , an adjustment weight will be displayed. The right digit flashes. Or confirm value with  , or enter a new value with the keys  and  confirm by .
	⇒ Place a corresponding adjustment weight, wait for stability display and confirm by .
	⇒ [-----] will be shortly displayed, followed by [FO CAL] The adjustment is now finished. Should an error occur, repeat adjustment.

## **13 MAINTENENCE**

### **13.1 General**

If the scale does not operate properly, find out the problem as possible. Determine whether the problem is constant or alternate. Be aware that problems can be caused by mechanical or electrical influences.

Check the following.

- Water
- Corrosive materials
- Vibrations or temperature or wind
- Physical damage

Check the scale cables for damage, and check all connections and connectors for any loose contact or incorrect connection

### **13.2 Cleaning**

- Disconnect the power before cleaning.
- Use a cloth with mild suds and light cleaning agents.
- Make sure that fluid not able to get into the device.
- Use a clean and soft cloth for rub off.

### **13.3 Determine the Problem**

Determine whether the problem is in the PCB or the Load Cell

- Remove power from the system, and disconnect the load cell connection from the PCB
- Connect the PCB to a load cell simulator
- Reapply power and test the PCB
- If problem goes away, its source is probably in the Load cell. Check the wiring, connector, load cell and mechanical components of the load cell.

If problem persists, its source is probably in the PCB. Check the PCB voltages, connectors, cables and function programs

### **13.4 Check the Load cell**

- Remove power from the system, and disconnect the PCB from the Load cell
- Check the moisture, or foreign material inside.
- Make sure all leads are connected and correctly.
- Check load cell for proper input and output resistances

### 13.5 Load Cell Connections

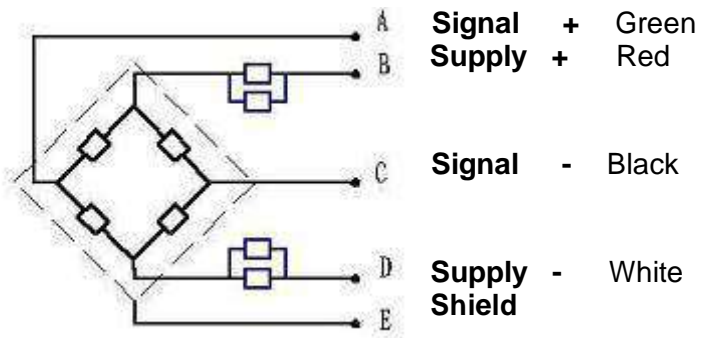

Measuring Points	Resistance
Red (+ Exc) to White (-Exc)	420 $\pm$ 20 $\Omega$
Green (+Sig) to Black (-Sig)	350 $\Omega$ $\pm$ 5 $\Omega$

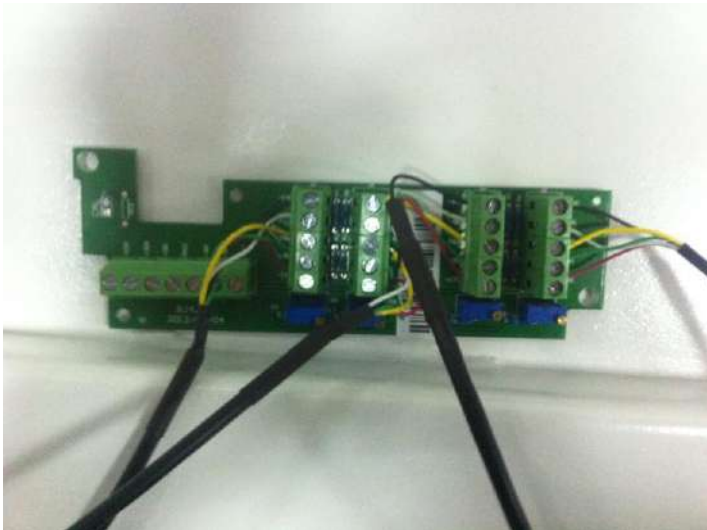

Load cell connection for the 4 load cell's.

RED ----- EXE +  
 WHITE----- SIG -  
 GREEN----- SIG +  
 BLACK----- EXE -  
 YELLOW---- SHIELD



Connection for the indicator

RED ----- EXE +  
 Empty----- SEN +  
 GREEN----- SIG +  
 BLACK----- SHIELD  
 BLUE----- SIG -  
 Empty----- SEN -  
 YELLOW---- EXE -

### **13.6 Check PCB Voltages**

If the problem is in the PCB, use a multimeter to check the following voltages

### **13.7 PCB Input Voltage**

Check the PCB input power connector voltage

- Voltage must be minimum 9VDC in to the pin AD+

### **13.8 Check Battery Voltage**

Check the Battery Voltage

- The battery voltage below the 1.5VDC, replace the battery and install new 1.5V battery.

### 13.9 Replace Main Board

Release 4 pcs screw from bottom of the scale by using cross screw driver.

Open the top cover, the main board lie on top cover, use cross screw driver loose 4 screw for main board, pull out all connector on the main board, then you can bring out main board carefully.



Install the new main board, plug all connector at last, After check anything , try to turn on the power , if anything is OK , close the top cover , replace main board completely.

### 13.10 Replace Battery

Open battery compartment cover

Remove the dry battery



Insert new batteries , Lock the battery cover again.



# 14 Drawing

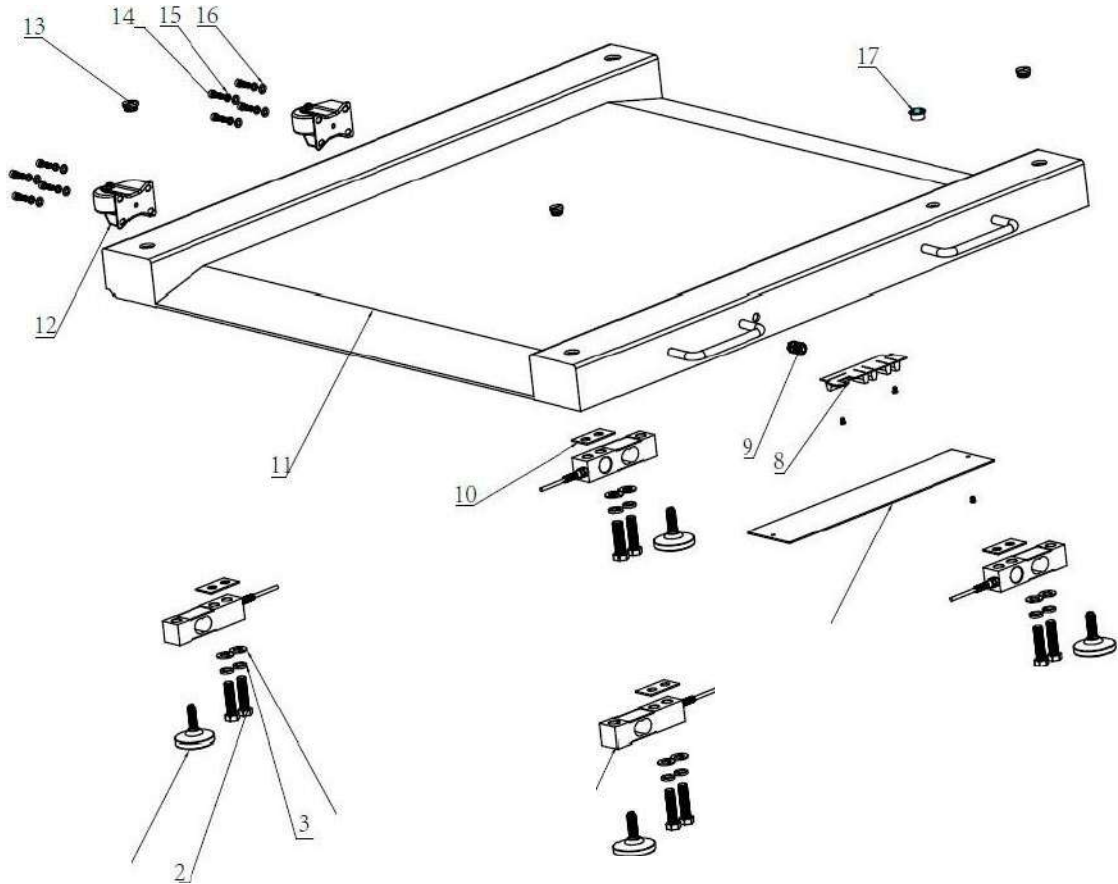

# 15 Schematic

