



KERN & Sohn GmbH

Ziegelei 1
D-72336 Balingen
E-Mail: info@kern-sohn.com

Tel: +49-[0]7433- 9933-0
Fax: +49-[0]7433-9933-149
Internet: www.kern-sohn.com

Operating instructions

Pocket balance

KERN CM

Version 2.0
2018-01
GB



Importør:
Impex Produkter AS
Gamle Drammensvei 107
1363 HØVIK
Tel. 22 32 77 20
info@impex.no
www.impex.no

CM-BA-e-1820



KERN CM

Version 2.0 2018-01

Operation instructions

Pocket Balance

Table of contents

1	Technical data	3
2	Declaration of conformity	4
3	Fundamental information (general)	4
3.1	Intended use	4
3.2	Inappropriate use.....	4
3.3	Guarantee.....	4
3.4	Monitoring the test substances.....	5
4	Fundamental safety information	5
4.1	Observe the information in the operating instructions.....	5
4.2	Staff training	5
5	Transport and storage	5
5.1	Acceptance check	5
5.2	Packaging.....	5
6	Unpacking, installation and commissioning	5
6.1	Place of installation, place of use	5
6.2	Unpacking.....	6
6.2.1	Installation	6
6.2.2	List of items supplied	6
6.3	Battery operation and change	7
6.4	Draft shield + weighing container (CM 50-C2N).....	7
6.5	Initial start-up	7
6.6	Adjustment.....	8
6.7	Adjusting.....	8
7	Operation	9
7.1	Overview of display CM 60-2N / CM 150-1N / CM 320-1N / CM 1K1N	9
7.2	Overview of display CM 50-C2N	9
7.3	Operating elements	9
7.3.1	Weighing.....	9
7.3.2	Taring.....	10
7.3.3	Plus/Minus Weighings	10
7.3.4	Net-total weighings	10
7.3.5	Unit change	11
7.4	Rear illuminated display	12
7.5	Calculator	13
8	Maintenance, upkeep, disposal	14
8.1	Cleaning	14
8.2	Maintenance, upkeep	14
8.3	Disposal.....	14
9	Troubleshooting	15

1 Technical data

KERN	CM 60-2N	CM150-1N	CM 320-1N	CM 1K1N
Readout (d)	0,01 g	0,1 g	0,1 g	1 g
Weighing range (max)	60 g	150 g	320 g	1.000 g
Taring range (subtractive)	60 g	150 g	320 g	1.000 g
Recommended adjusting weight, not included (class)	50 g (M2)	100 g (M3)	200 g (M3)	1000 g (M3)
Optimal temperature range	18 – 25 °C			
Units	g / tol / tlt			
Permissible relative humidity	< 85 % (non-condensing)			
Weighing plate mm	70 x 80			
Size (B x H x T) mm	85 x 130 x 25			

KERN	CM 50-C2N	
Readout (d)	0,01 ct	0,002 g
Weighing range (max)	50ct	10 g
Taring range (subtractive)	50ct	10 g
Test weight (included)	5 g (M1)	
Units	ct / g	
Optimal temperature range	18 – 25 °C	
Permissible relative humidity	< 85 % (non-condensing)	
Weighing plate mm	40 x 50	
Size (B x H x T) mm	85 x 130 x 25	

2 Declaration of conformity

To view the current EC/EU Declaration of Conformity go to:

www.kern-sohn.com/ce

3 Fundamental information (general)

3.1 Intended use

The balance you have acquired serves to determine the weighing value of the material to be weighed. It is intended to be used as a “non-automatic” balance, i.e. the material to be weighed is manually and carefully placed in the centre of the weighing plate. The weighing value can be read off after a stable weighing value has been obtained.

3.2 Inappropriate use

Do not use the balance for dynamic weighing. In the event that small quantities are removed or added to the material to be weighed, incorrect weighing results can be displayed due to the “stability compensation” in the balance. (Example: Slowly draining fluids from a container on the balance.)

Do not leave a permanent load on the weighing plate. This can damage the measuring equipment.

Be sure to avoid impact shock and overloading the balance in excess of the prescribed maximum load rating (max.), minus any possible tare weight that is already present. This could cause damage to the balance.

Never operate the balance in hazardous locations. The series design is not explosion-proof.

Structural alterations may not be made to the balance. This can lead to incorrect weighing results, faults concerning safety regulations as well as to destruction of the balance.

The balance may only be used in compliance with the described guidelines. Varying areas of application/planned use must be approved by KERN in writing.

3.3 Guarantee

The guarantee is not valid following

- non-observation of our guidelines in the operating instructions
- use outside the described applications
- alteration to or opening of the device
- mechanical damage and damage caused by media, liquids
- natural wear and tear
- inappropriate erection or electric installation
- overloading of the measuring equipment

3.4 Monitoring the test substances

The metrology features of the balance and any possible available adjusting weight must be checked at regular intervals within the scope of quality assurance. For this purpose, the answerable user must define a suitable interval as well as the nature and scope of this check. Information is available on KERN's home page (www.kern-sohn.com) with regard to the monitoring of balance test substances and the test weights required for this. Test weights and balances can be adjusted quickly and at a reasonable price in KERN's accredited DKD calibration laboratory (return to national normal).

4 Fundamental safety information

4.1 Observe the information in the operating instructions

Please read the operating instructions carefully before erecting and commissioning, even if you already have experience with KERN balances.

4.2 Staff training

The device may only be operated and looked after by trained members of staff.

5 Transport and storage

5.1 Acceptance check

Please check the packaging immediately upon delivery and the device during unpacking for any visible signs of external damage.

5.2 Packaging

Please retain all parts of the original packaging in case it should be necessary to return items at any time.

Only the original packaging should be used for return consignments.

6 Unpacking, installation and commissioning

6.1 Place of installation, place of use

The balance is constructed in such a way that reliable weighing results can be achieved under normal application conditions.

By selecting the correct location for your balance, you will be able to work quickly and precisely.

Therefore please observe the following at the place of installation:

- Place the balance on a firm, level surface;
- Avoid extreme heat as well as temperature fluctuation caused by installing next to a radiator or in the direct sunlight;
- Protect the balance against direct draughts due to open windows and doors;
- Avoid jarring during weighing;
- Protect the balance against high humidity, vapours and dust;

- Do not expose the device to extreme dampness for longer periods of time. Inadmissible bedewing (condensation of air moisture on the device) can occur if a cold device is taken into a significantly warmer environment. In this case, please acclimatise the device for approx. 2 hours at room temperature after it has been disconnected from the mains.
- Avoid static charging of the material to be weighed, weighing container and windshield.

Major display deviations (incorrect weighing results, or a failure function of the calculator) are possible if electromagnetic fields occur as well as due to static charging and instable power supply. It is then necessary to change the location.

If the calculator is interrupted by static charging, reset it to normal by pressing the "ON/AC" button.

6.2 Unpacking

Carefully remove the balance from its packaging, remove the plastic wrapping and position the balance in its intended working location.

6.2.1 Installation

Install the balance in such a fashion that the weighing plate is absolutely horizontal.

6.2.2 List of items supplied

Standard accessories:

- Pocket balance
- Batteries
- Operating instructions
- Weighing container (only CM 50-C2N)
- Draft shield (only CM 50-C2N)

6.3 Battery operation and change

- Battery conservation through automatic power-off 3 –4 minutes after ending a weighing operation.
- When the battery power is used the display will show “LO”. Press the  key and change the batteries at once.

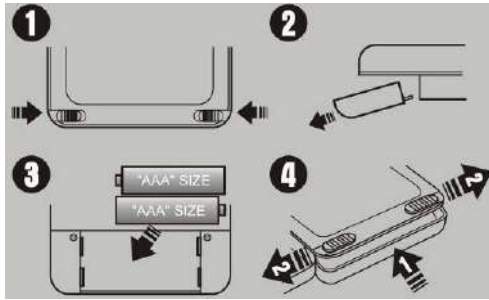

Battery change

1. Open the battery compartment cover located at the bottom of the balance (Unlocking battery compartment cover (**picture 1+2**).
2. Insert 2 AAA type batteries (**picture 3**) .
3. Re-insert and lock the battery cover.(**picture 4**).

When the balance is not in use for a longer period of time remove batteries and keep them separately. Leakage of battery liquid might damage the balance.

6.4 Draft shield + weighing container (CM 50-C2N)

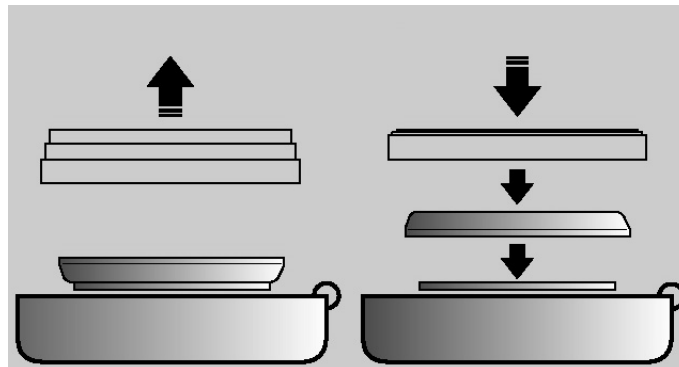

Before weighing:

- Put on Weighing pan
- Unfold draft shield
- Place the weighing material on weighing plate.
- put on draft shield.

After weighing:

- Put Draft shield and weighing pan over weighing plate

6.5 Initial start-up

A warm-up time of 1 minutes stabilises the measured values after switching on. The accuracy of the balance depends on the local acceleration of the fall. Please be sure to observe the information in the chapter on adjusting.

6.6 Adjustment

As the acceleration value due to gravity is not the same at every location on earth, each balance must be coordinated – in compliance with the underlying physical weighing principle - to the existing acceleration due to gravity at its place of location (only if the balance has not already been adjusted to the location in the factory). This adjustment process must be carried out during the initial start-up, after change in location and variation of surrounding temperature. It is also recommendable to adjust the balance periodically during weighing operation in order to obtain exact measured values.

6.7 Adjusting

Using a precision weight, the accuracy of the balance can be checked at any time and adjusted.

Adjustment procedure:

Check that the surrounding conditions are stable.

A short warm-up time of about 1 minutes are recommended for stabilisation.

Press  key approx. 3 seconds, "CAL" and then the exact weight of the adjusting weight will appear the display.

Place the adjusting weight on the centre of the weighing plate.

"F" will appear somewhat later, and then turn off.

In case of an adjusting error or a wrong adjusting weight "E" appears in the display.

7 Operation

7.1 Overview of display CM 60-2N / CM 150-1N / CM 320-1N / CM 1K1N (Units on display)



7.2 Overview of display CM 50-C2N (Units on panel sheet)

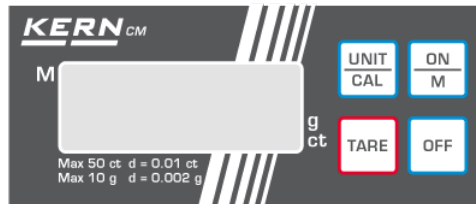

7.3 Operating elements

7.3.1 Weighing

Switch the balance on by pressing the  key.

The balance will show “8888” for approx. 3 seconds and then change to “0”. Now it is ready for use.

Important: If the display does not show 0, press the  key.

Only now (!) place object on the weighing pan. Make sure that the weighing object does not stripe or touch the housing or base.

If the object should be heavier than the weighing range allowance, the symbol “E” (overload) will appear on the display .

7.3.2 Taring

Switch the balance on by pressing the  key, then wait for the “0” indication.

Place the tare cup on the weighing plate and press the  key. Indication will go to “0”. Now the weight of the cup is memorised internally.

Fill the object into the cup, read the measuring value.

By pressing the  key after a weighing procedure, “0” will appear on the display again.

The taring procedure can be repeated continuously, for instance when mixing several components.

The limit is reached when the full weighing range is overlay.

After having removed the tare cup, the total weight will appear as a negative value.

7.3.3 Plus/Minus Weighings

For instance to control **piece-weights**.

Switch the balance on by pressing the  key, then wait until “0” is indicated.

Place rated weight on the weighing plate and tare on “0” by  key. Remove rated weight.

Place the objects on the weighing pan successively, the balance will show any deviation from the rated weight in “+” and “-”.

According to the same procedure packages with the same weight, related to a rated weight, can be produced. Return to the weighing mode by pressing the  key.



7.3.4 Net-total weighings

Useful when a mixture of several components will be weighed in a tare cup, and finally the sum weight of all components weighed in will be needed for direction (net-total, i.e. without the weight of the tare cup).

Example:

Tare cup on weighing plate, tare on “0” by pressing the  key.



Weigh component ❶ and tare back to “0” with the  key. The activation of the memory is shown by a triangle on the far left of the display.

Weigh component ❷, by pressing the  key the net total is displayed, this means the sum of component ❶ and ❷. Tare to “0” by pressing the  key.

Weigh component ❸, by pressing the  key the net-total is displayed, this means the sum of the components ❶ and ❷ and ❸.

If necessary fill the formula container up to the desirable level. To return to the weighing mode press the  key

7.3.5 Unit change

Switch the balance on by pressing the  key, then wait for the “0” indication. The units set in the balance can be selected between the different units, by pressing the  key

Models:

CM 60-2N / CM 150-1N / CM 320-1N / CM 1K1N

	<i>Display</i>	<i>Conversion factor</i> 1 g =
Gramm *	g	1
Tael Taiwan	tlt	0.02667
Tola	tol	0.08573

* Factory setting

Model:

CM 50-C2N



	<i>Display</i>	<i>Conversion factor</i> 1 g =
Gramm *	g	1
Carat	ct	5

* Factory setting

7.4 Rear illuminated display

To choose the backlight mode, please follow the below instruction for the setting:

Turn off the balance.

Press and hold the  key, then press the  key one time; after that release the  key. Display shows „bl“.

Press the  key to confirm the entry of the backlight mode.

Press the  key to switch among the modes:

Display	Mode	Function
„bl“ on	Backlight on	Contrasting display which can also be read in the dark.
„bl“ off	Backlight off	Save the battery
„bl“ Ch	Backlight switches automatically off 10 sec after stable indication	Save the battery

Confirm with the  key.

7.5 Calculator

(not included in model CM50-C2N)

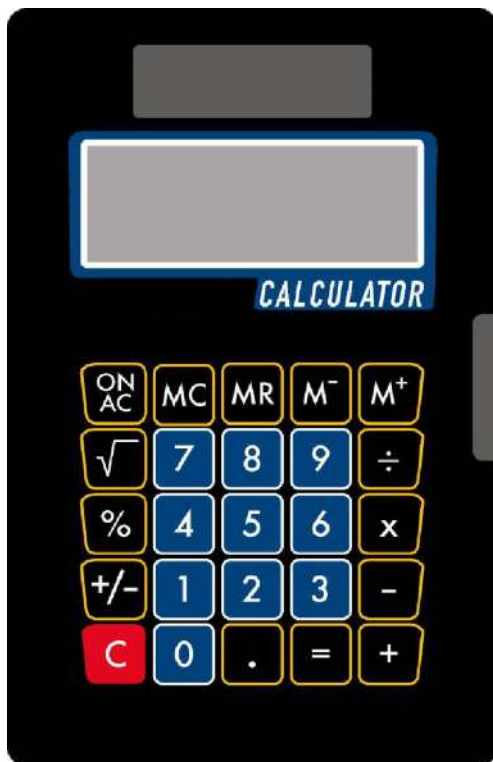

KERN CM Calculator	
ON/AC	Switch ON /All clear
+	Addition
-	Subtraction
÷	Division
x	Multiplication
=	Result
%	Percent
M +	Memory plus
M -	Memory minus
MC	Memory clear
MR	Independent Memory recall
+/-	Sign change
√	Square Root
,	Comma
C	Clear

Notice:

Data exchange between balance and pocket calculator is not possible.

8 Maintenance, upkeep, disposal

8.1 Cleaning

Please disconnect the device from the operating voltage before cleaning.

Only use a cloth dampened with mild suds and not aggressive cleaning agents (solvents or similar). Please ensure that fluids are not able to get into the device and rub off using a clean, soft cloth.

Loose sample residue/powder can be removed carefully using a brush or hand vacuum cleaner.

Remove any spilt material to be weighed immediately.

8.2 Maintenance, upkeep

The device may only be opened by trained service engineers authorised by KERN.

8.3 Disposal

The operating company shall dispose of the packaging and the device in compliance with the valid national or regional law of the operating location.

9 Troubleshooting

The balance should be switched off for a short time following an interruption in the programme sequence . It is then necessary to repeat the weighing process from the beginning.

Help:

Interruption

Possible cause

Weight display is not illuminated.

- The balance is not switched on.
- The batteries are wrongly inserted, the batteries are empty
- No batteries are attached

The weight display changes continually

- Draught/air movement
- Table/floor vibrations
- The weighing plate is in contact with foreign matter.
- Electromagnetic fields / static charging (choose different location/switch off interfering device if possible)

The weighing result is obviously incorrect

- The balance display is not set to zero
- Adjustment is no longer correct.
- Great fluctuations in temperature.
- Electromagnetic fields / static charging (choose different location/switch off interfering device if possible)

Switch the balance off if other error messages should appear and then switch on again. Contact the manufacturer if the error message does not disappear.