

HI5521 & HI5522

pH/mV/ISE/Temperature/
Conductivity/Resistivity/TDS/Salinity
Bench Meters



INSTRUCTION MANUAL

Dear Customer,

Thank you for choosing a Hanna Instruments product.

Please read this instruction manual carefully before using the instrument.

This manual will provide you with the necessary information for correct use of the instrument, as well as a precise idea of its versatility.

If you need additional technical information, do not hesitate to e-mail us at tech@hannainst.com or view our worldwide contact list at www.hannainst.com.

All rights are reserved. Reproduction in whole or in part is prohibited without the written consent of the copyright owner, Hanna Instruments Inc., Woonsocket, Rhode Island, 02895, USA.

PRELIMINARY EXAMINATION	4
GENERAL DESCRIPTION	5
FUNCTIONAL DESCRIPTION	6
SPECIFICATIONS	8
OPERATIONAL GUIDE	11
DISPLAYING MODES	12
SYSTEM SETUP	15
CHANNEL SELECTION	21
pH SETUP	22
mV SETUP	35
ISE SETUP (HI5522 only)	37
pH CALIBRATION	45
pH MEASUREMENT	49
mV & Relative mV MEASUREMENTS	51
ISE CALIBRATION (HI5522 only)	53
ISE MEASUREMENT (HI5522 only)	56
CONDUCTIVITY SETUP	62
RESISTIVITY SETUP	76
TDS SETUP	78
SALINITY SETUP	80
CONDUCTIVITY CALIBRATION	82
CONDUCTIVITY MEASUREMENT	84
USP EVALUATION	85
RESISTIVITY MEASUREMENT	89
TDS MEASUREMENT	90
SALINITY CALIBRATION	91
SALINITY MEASUREMENT	92
TEMPERATURE CALIBRATION	93
LOGGING	94
PC INTERFACE	97
ADDITIONAL INFORMATION	98
pH BUFFER TEMPERATURE DEPENDENCE	101
EC PROBE USE AND MAINTENANCE	102
ELECTRODE CONDITIONING AND MAINTENANCE	103
TROUBLESHOOTING GUIDE	105
TEMPERATURE CORRELATION FOR pH SENSITIVE GLASS	107
ACCESSORIES.....	108

Remove the instrument from the packing material and examine it carefully to make sure that no damage has occurred during shipping. If there is any damage, notify your Dealer or the nearest Hanna Customer Service Center.

The meters are supplied complete with:

- [HI1131B](#) Glass-body Combination pH Electrode
- [HI76312](#) Four-ring Conductivity Probe with built-in temperature sensor and ID
- [HI7662-W](#) Temperature probe
- [HI7082S](#) Electrolyte solution
- [HI76404W](#) Electrode Holder
- pH and Conductivity Calibration Solutions Kit
- Capillary dropper pipette
- 12 Vdc Power Adapter
- Instruction Manual and Quick Reference Guide
- Certificate

[HI5521-01](#) and [HI5522-01](#) are supplied with 12 Vdc/120 Vac adapter.

[HI5521-02](#) and [HI5522-02](#) are supplied with 12 Vdc/230 Vac adapter.

Note: Save all packing material until you are sure that the instrument works properly. Any defective item must be returned in the original packing with the supplied accessories.

HI5521 and HI5522 are professional bench meters with color graphic LCD for pH, ORP (Oxidation Reduction Potential), ISE (HI5522 only), conductivity, resistivity, TDS, salinity and temperature measurements.

The display can be configured as a single channel or dual channel display in various modes: Basic information only, GLP information, Graph and Log History mode.

The main features of the instruments are:

- Two input channels: one for potentiometric sensors, the other for electrolytic conductivity;
- Capacitive touch keypad;
- Eight measurement parameters: pH, mV, ISE (HI5522 only), conductivity, resistivity, TDS, salinity and temperature;
- Dedicated Help key with contextual message;
- Manual selection, automatic and semiautomatic pH calibration in up to five points, with standard (pH 1.68, 3.00, 4.01, 6.86, 7.01, 9.18, 10.01 and 12.45) and custom buffers (up to five custom buffers);
- Manual Selection and Custom Standard ISE calibration in up to five points, with standard (up to seven standard solutions for each measurement unit) and custom solutions (up to five custom solutions), with or without temperature compensation (HI5522 only);
- Application for water for injection follows the USP <645> protocol;
- Conductivity probe automatic recognition;
- Automatic or custom standard conductivity calibration in up to four points, probe offset calibration;
- Single point salinity calibration (Percent Scale only);
- AutoHold feature to freeze first stable reading on the LCD;
- Two selectable alarm limits (for pH, mV, ISE, conductivity, resistivity, TDS, salinity);
- Three selectable logging modes: Automatic, Manual, AutoHold logging;
- Continuous Lot logging directly on meter, with selectable log interval: Store up to 100,000 total data points;
- Up to 100 logging lots for automatic or manual modes and up to 200 USP reports, up to 100 ISE methods reports;
- Selectable sampling period feature for automatic logging;
- Basic Measurement can be viewed with detailed GLP information, or with a Graph or a Log History (while continuously logging);
- Online and offline graph;
- Large color backlight graphic LCD (240 x 320 pixels) with user selectable color palette;

- PC interface via USB; download logged data to PC or use for Real time logging (HI92000 PC application required);
- Profile feature: store up to five different user setup on each channel.

HI5521 / HI5522 DESCRIPTION

FRONT PANEL

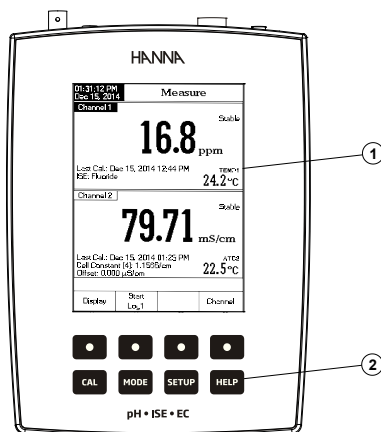

REAR PANEL

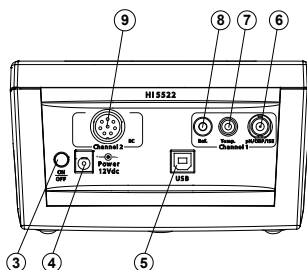

- 1) Liquid Crystal Display (LCD)
- 2) Capacitive touch keypad
- 3) ON/OFF switch
- 4) Power adapter socket
- 5) USB connector
- 6) BNC electrode connector for pH/ORP/ISE measurements
- 7) Temperature probe socket
- 8) Reference input socket
- 9) Conductivity probe connector

KEYBOARD DESCRIPTION

FUNCTION KEYS

- CAL** To enter/exit calibration mode;
- MODE** To select the desired measurement mode, pH, mV, Rel mV, ISE (HI5522 only), Conductivity, Resistivity, TDS, Salinity;
- SETUP** To enter Setup (System Setup, pH Setup, mV Setup, ISE Setup (HI5522 only), Conductivity Setup, Resistivity Setup, TDS Setup or Salinity Setup) and to access Log Recall function;
- HELP** To obtain general information about the selected option/operation.

VIRTUAL KEYS

The upper row keys are assigned to the **virtual keys** placed on the bottom of the LCD, which allow you to perform the displayed function, depending on the current menu (e.g. **Display**, **Start Log 1** and **Channel** in **Measure** mode).

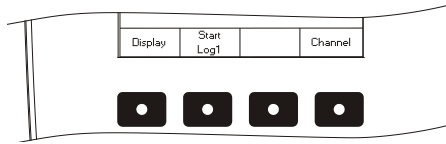

*Note: All the virtual keys are assigned to the highlighted channel (highlighted with **Channel** key).*

LCD GENERAL DESCRIPTION

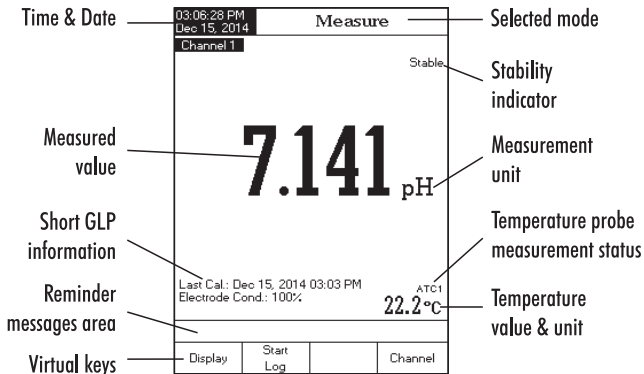

		HI5521	HI5522
pH	Range	-2.0 to 20.0 pH / -2.00 to 20.00 pH / -2.000 to 20.000 pH	
	Resolution	0.1 pH / 0.01 pH / 0.001 pH	
	Accuracy	±0.1 pH / ±0.01 pH / ±0.002 pH ± 1LSD	
	Calibration	Up to five-point calibration, eight standard buffers available (pH 1.68, 3.00, 4.01, 6.86, 7.01, 9.18, 10.01, 12.45), and five custom buffers	
mV	Range	±2000.0 mV	
	Resolution	0.1 mV	
	Accuracy	±0.2 mV ± 1LSD	
Relative mV offset range		±2000.0 mV	
ISE	Range	-	e.g. 10 ⁻⁷ to 10M, 0.005 to 10 ⁵ ppm 5·10 ⁻⁷ to 5·10 ⁷ conc.
	Resolution	-	1 conc. / 0.1 conc. / 0.01 conc. / 0.001 conc.
	Accuracy	-	±0.5% (monovalent ions) ±1% (divalent ions)
	Calibration	-	Up to five-point calibration, seven fixed standard solutions available for each measurement unit, and five custom solutions

		HI5521	HI5522
Conductivity	Range	0.000 to 9.999 $\mu\text{S}/\text{cm}$ 10.00 to 99.99 $\mu\text{S}/\text{cm}$ 100.0 to 999.9 $\mu\text{S}/\text{cm}$ 1.000 to 9.999 mS/cm 10.00 to 99.99 mS/cm 100.0 to 1000.0 mS/cm	
	Resolution	0.001 $\mu\text{S}/\text{cm}$ 0.01 $\mu\text{S}/\text{cm}$ 0.1 $\mu\text{S}/\text{cm}$ 0.001 mS/cm 0.01 mS/cm 0.1 mS/cm	
	Accuracy	$\pm 1\%$ of reading ($\pm 0.01 \mu\text{S}/\text{cm}$)	
	Cell constant	0.0500 to 200.00	
	Cell type	4 cells	
	Calibration type/points	Auto standard recognition / User standard, Single Point / Multi Point calibration	
	EC calibration solution	84.00 $\mu\text{S}/\text{cm}$, 1.413 mS/cm , 5.000 mS/cm , 12.88 mS/cm , 80.00 mS/cm , 111.8 mS/cm	
	Conductivity probe recognition	Yes	
	Temperature compensation	Disabled / Linear / Non linear (natural water)	
	Temperature coefficient	0.00 to 10.00 $\%/^{\circ}\text{C}$	
	Reference temperature	5.0 $^{\circ}\text{C}$ to 30.0 $^{\circ}\text{C}$	
	Profiles	Up to 10 (5 for each)	
	USP <645> Application	Yes	
Resistivity	Range	1.0 to 99.9 $\Omega\cdot\text{cm}$ 100 to 999 $\Omega\cdot\text{cm}$ 1.00 to 9.99 $\text{K}\Omega\cdot\text{cm}$ 10.0 to 99.9 $\text{K}\Omega\cdot\text{cm}$ 100 to 999 $\text{K}\Omega\cdot\text{cm}$ 1.00 to 9.99 $\text{M}\Omega\cdot\text{cm}$ 10.0 to 100.0 $\text{M}\Omega\cdot\text{cm}$	
	Resolution	0.1 $\Omega\cdot\text{cm}$ 1 $\Omega\cdot\text{cm}$ 0.01 $\text{K}\Omega\cdot\text{cm}$ 0.1 $\text{K}\Omega\cdot\text{cm}$ 1 $\text{K}\Omega\cdot\text{cm}$ 0.01 $\text{M}\Omega\cdot\text{cm}$ 0.1 $\text{M}\Omega\cdot\text{cm}$	
	Accuracy	$\pm 2\%$ of reading ($\pm 1 \Omega\cdot\text{cm}$)	
	Calibration	No	

		HI5521	HI5522
TDS	Range	0.000 to 9.999 ppm 10.00 to 99.99 ppm 100.0 to 999.9 ppm 1.000 to 9.999 ppt 10.00 to 99.99 ppt 100.0 to 400.0 ppt actual TDS (with 1.00 factor)	
	Resolution	0.001 ppm 0.01 ppm 0.1 ppm 0.001 ppt 0.01 ppt 0.1 ppt	
	Accuracy	±1% of reading (±0.01 ppm)	
Salinity	Range	Practical Scale 0.00 to 42.00 psu Natural Sea Water 0.00 to 80.00 ppt Percent Scale 0.0 to 400.0 %	
	Resolution	0.01 for Practical Scale / Natural Sea Water 0.1 % for Percent Scale	
	Accuracy	±1% of reading	
	Calibration	Percent Scale - 1 point (with HI7037 standard)	
Temperature	Range	-20.0 to 120.0 °C -4.0 to 248.0 °F 253.2 to 393.2 K	
	Resolution	0.1 °C / 0.1 °F / 0.1 K	
	Accuracy	±0.2 °C / ±0.4 °F / ±0.2 K (without probe)	
	Calibration	User calibration in 3 points (0, 50, 100 °C)	
Input channels		2 (pH/mV; Conductivity/Resistivity/TDS/Salinity)	2 (pH/mV/ISE; Conductivity/Resistivity/TDS/Salinity)
PC interface		Opto-isolated USB	
GLP Channel 1		Electrode offset / slope, calibration points, calibration time stamp	
GLP Channel 2		Probe cell constant / offset, reference temperature, compensation coefficient, calibration points, calibration time stamp	
Auto Hold		Yes	
Calibration reminder		Yes	

Logging feature	Record	Up to 100 lots, 50,000 records max/lot / maximum 100,000 data points / channel
	Interval	14 selectable between 1 second and 180 minutes
	Type	Automatic, Manual, AutoHold
	pH Electrode	HI1131B
	EC Probe	HI76312
	Temperature Probe	HI7662-W
	Implemented standards	USP stage 1, 2, 3
	LCD	Color Graphic LCD 240 x 320 pixels
	Keyboard	8 keys capacitive touch
	Power Supply	12 Vdc adapter
	Dimensions	160 x 231 x 94 mm (6.3 x 9.1 x 3.7")
	Weight	1.2 Kg (2.6 lbs)

POWER CONNECTION

Plug the 12 Vdc adapter into the power supply socket.

Note: These instruments use non-volatile memory to retain the meter settings, even when unplugged.

ELECTRODE AND PROBE CONNECTIONS

For pH or ORP measurements, connect a pH/ORP electrode with internal reference to the BNC connector located on the rear panel of the instrument.

For ISE measurements (HI5522), connect an ISE electrode with internal reference to the BNC connector located on the rear panel of the instrument.

For electrodes with a separate reference, connect the electrode's BNC to the BNC connector and the electrode's reference to the reference input socket.

For temperature measurement and automatic temperature compensation, connect the temperature probe to the appropriate socket (Channel 1 only).

For conductivity, resistivity, TDS or salinity measurements, connect a conductivity probe to the DIN connector located on the rear panel of the instrument.

INSTRUMENT START UP

- Please ensure that the capacitive keypad is not covered by hand or other objects at the meter power on.
- Turn the instrument on from the power button located on the rear panel of the instrument.
- Please wait until the instrument finishes the initialization process.

Note: It is normal for the loading process to take a few seconds. If the instrument doesn't display the next screen, restart the meter using the power button. If the problem persists, contact your dealer.



For measurement mode's the following display configurations are available: Basic, Good Laboratory Practice (GLP), Graph and Log History.

Basic

The main measured value and its units are displayed on the LCD, along with the temperature value, temperature probe status and basic calibration information (when available).

To choose the **Basic** display mode:

- Press **Display** while in **Measure** mode. The "Choose Display Configuration" message will be displayed in the Reminder messages area.
- Press **Basic**. The instrument will display the basic information for the selected measurement mode.

01:31:12 PM Dec 15, 2014		Measure	
Channel 1		16.8	Stable
		ppm	
Last Cal.: Dec 15, 2014 12:44 PM		TEMP1	24.2°C
ISE: Fluoride			
Channel 2		79.71	Stable
		mS/cm	
Last Cal.: Dec 15, 2014 01:29 PM		ATC2	22.5°C
Cell Constant [4]: 1.1566/cm			
Offset: 0.000 µS/cm			
Display	Start Log1		Channel

GLP (pH, ISE, Conductivity and Salinity mode only)

Detailed GLP data will be displayed on the custom LCD for the selected measurement when this option is selected: Last Calibration date and time, Offset and Slope values, Calibration Buffers/Standards and general information regarding the buffers/standards, the calibration temperature, temperature compensation mode, date and time. For pH Measure, the Electrode Condition is also displayed on the LCD in percent.

Note: If a single-point pH calibration is performed or the current calibration does not include at least two consecutive standard buffers of pH 4.01, 7.01 (6.86) and 10.01 (9.18) the Electrode Condition will be unknown. Electrode Condition remains active for 24 hours after a calibration.

To access the **GLP** display option:

- Press **Display** while in **Measure** mode. The “Choose Display Configuration” message will be displayed in the Reminder messages area.
- Press **GLP**. The instrument will display the detailed GLP data.

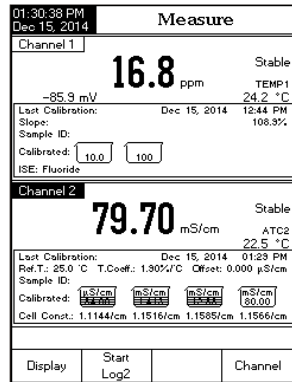

Graph

The on-line graph with real time logging (pH, mV, Rel mV, ISE, Conductivity, Resistivity, TDS, Salinity vs. Seconds) will be displayed when this option is selected.

If there is no active log, the previously logged data for the selected parameter will be shown.

To access the **off-line / on-line graph**:

- Press **Display** while in **Measure** mode. The “Choose Display Configuration” message will be displayed in the Reminder messages area.
- Press **Graph**
- Press **Start Log** to begin online graph.

To Zoom Graph

- Press **Display** then **Graph**, **<** and **>** will appear in virtual keys.
- Use **<** and **>** to move along the X (Time) axis of the graph.

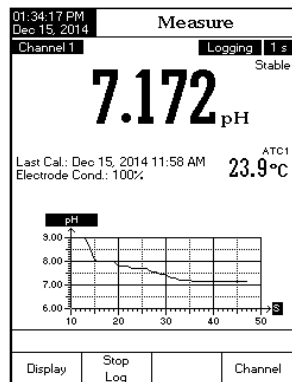

- Press **SETUP** to access the zoom menu for Y axis. Use **Zoom IN** or **Zoom OUT** for zooming Y (parameter) axis.
- Press **Escape** to return to the main menu.

When the **off-line graph** is displayed:

- Use the arrow keys to move along the X (Time) and Y (parameter) axes of the graph.
- Press **SETUP** to access the zoom menu for X and Y axes. Use **Zoom Time** or **Zoom pH** / **Zoom mV** / **Zoom Rel.mV** / **Zoom ISE** / **Zoom Cond.** / **Zoom Resistiv.** / **Zoom TDS** / **Zoom Salinity** to switch between the active zooming axes. Press **Zoom IN** or **Zoom OUT** to zoom the selected axis.

*Note: While in zoom graph menu the **MODE** key is not accessible.*

- Press **Escape** to return to the main menu.

Log History

The measurement, along with **Log History**, will be visible when this option is selected:

- 1) The last stored logged data (Not actively logging) or
- 2) The last data logged from an active logging lot or
- 3) An empty display - NO LOTS saved, Not currently logging

The log history list also contains the main measured value, the appropriate mV, the temperature, the temperature probe source, as well as a record time stamp.

To access the **Log History** display option:

- Press **Display** while in **Measure** mode. The “Choose Display Configuration” message will be displayed in the Reminder messages area.
- Press **Log History**. The instrument will display the log history regarding the selected Measure mode.

Notes: When an alarm condition is active, the logged records will have an exclamation mark “!”.

If logged in Auto Hold, logged records will have an “H”.

If another Measure mode is selected, the Log History will reset.

If the temperature unit is changed, all logged temperature values will be automatically displayed in the new temperature unit.

“A” denotes automatic temperature compensation.

“M” denotes manual temperature compensation.

01:23:30 AM Dec 15, 2014		Measure	
Channel 1	AutoHold	Logging	Stable
10.049		pH	
Last Cal: Apr 11, 2014 02:03 PM		ATC1 24.4°C	
Electrode Cond.: 100%			
pH	mV	Temp[°C]	Time
10.048	-183.5	24.4 A	02:38:52PM
10.049	-183.5	24.4 A	02:38:45PM
10.048 H	-183.4	24.4 A	02:38:40PM
10.048 H	-183.4	24.4 A	02:38:35PM
10.048	-183.4	24.4 A	02:38:30PM
10.048	-183.3	24.4 A	02:38:25PM
8.679	-101.3	24.4 A	02:38:20PM
7.843	-51.1	24.4 A	02:38:15PM
5.040 !	112.4	24.4 A	02:38:10PM
Display	Stop Log	Continuous Reading	Channel

The **System Setup** menu allows the user to customize the user interface, view meter information, set the external serial communication interface and to restore the manufacturer settings.

Accessing System Setup

- Press **SETUP** while in **Measure** mode.
- Press **System Setup**. The system setup options will be displayed on the LCD.

To access a **System Setup** option:

- Use **Δ** or **∇** to highlight the desired option.
- Press **Select** to access the selected option.

The following is a detailed description of the System Setup option screen:



Beeper

This option allows the user to turn an acoustic warning signal on or off. This function can be used to signal 4 different events: a stable signal, an alarm state, when every key is pressed or when an incorrect key is pressed. Enable (or disable) the **Beeper** for these events. Disabling the **Beeper** will stop audible signals.

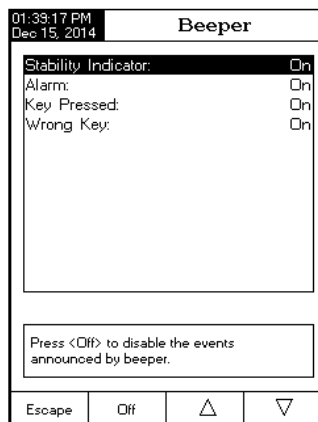

Saving Confirmation

Enable this option to force confirmation of a change made to a setting in GLP data option field or a Sample ID name. If **Saving Confirmation** is enabled, the user will have to accept the change with a key stroke.

If **Saving Confirmation** is disabled, the changes made to these fields change automatically without asking confirmation.

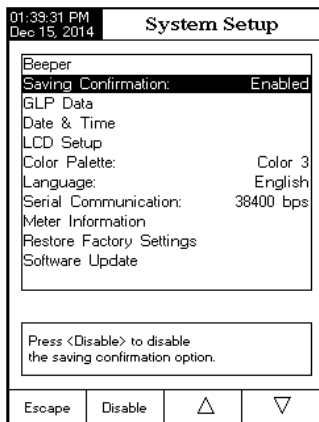

GLP Data

Use this option to customize logging GLP information with specific identification data. When enabled, these ID tags will be included in the GLP section of all data logs for all modes of operation. Each data field can use up to 10 characters.

The available fields are:

Operator ID : used to add the name of the operator.

Instrument ID : used to name an instrument with a discrete name, location or number.

Company Name : used to include the Company ID to the GLP data field.

Additional Info : two data fields are available for general notes or notations.

To add the **GLP Data**:

- Press **SETUP** while in **Measure** mode.
- Press **System Setup**.
- Use **▲** or **▼** to select the **GLP Data** option.
- Press **Select** and use **▲** or **▼** to highlight the desired option.
- Press **Select** to edit the desired information. The Text Editor menu will be displayed on the LCD.
- Enter the desired information by accepting the highlighted character which is added to the text bar, using **Select**. The **▶** and **◀** keys help the user to select the desired character. It is also possible to delete the last character by positioning the cursor on the Backspace character (**⌫**) and pressing **Select**.
- Press **Escape** to return to the **GLP Data** options. If the Saving Confirmation is enabled, press **Yes** to accept the modified option, **No** to escape without saving or **Cancel** to return to the editing mode. Otherwise, the modified options are saved automatically.

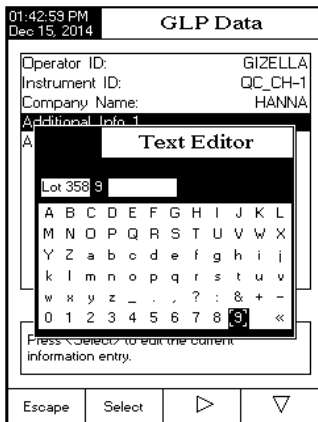

Date & Time

Set the current date & time and the format in which they appear.

Set Date and Time

This option allows the user to set the current date (year/month/day) and time (hour/minute/second).

Notes: Only years starting with 2000 are accepted.

*The time is set using the selected time format. For 12 Hour time format only, the AM/PM can also be selected with **▲** or **▼**.*

Set Time Format

Choose between 12 Hour (AM/PM) time format or 24 Hour time format.

Set Date Format

Choose the desired date format from 7 available options: DD/MM/YYYY, MM/DD/YYYY, YYYY/MM/DD, YYYY-MM-DD, Mon DD, YYYY, DD-Mon-YYYY or YYYY-Mon-DD.

To set the **Date & Time**:

- Press **SETUP** while in **Measure** mode.
- Press **System Setup**.

- Use or to select the **Date & Time** option.
- Press and use or to highlight the **Set Date and Time**.
- Press to confirm your selection. Use / to select next/previous entry to be edit. Press and use or to set the desired value, then press to save the modified value (for Set Date and Time option).
- For the other two options press to confirm your selection and select one of the displayed options.
- Press to return to previous menu. If the Saving Confirmation is enabled, press to accept the modified option, to escape without saving or to return to the editing mode. Otherwise, the modified option is saved automatically.

Note: If the time is changed with more than one hour before last pH/ISE calibration, a pop-up warning will appear on the LCD, notifying the user that a date/time conflict has occurred and some time-dependent features could work improperly (e.g. Measure, GLP, Log).

01:43:46 PM		Date & Time	
Enter the date and time:			
year	month	day	
2014	12	15	
hour minute second			
01	43	25	PM
Press <Escape> to exit to previous screen. Press <Edit> to edit the focused entry. Press <Next> or <Previous> to select entry.			
Escape	Edit	Next	Previous

LCD Setup

This option allows the user to set the Contrast, the Backlight of the LCD and the Backlight Saver. The Contrast parameter can be adjusted within 7 steps, while the Backlight parameter within 8 steps. The Backlight Saver can be set from 1 to 60 minutes or it can be OFF (disabled). All the changes are visible on the LCD for each parameter.

Note: If the instrument backlight turns off after the time period set, press any key to turn it back on.

To set the **LCD Setup**:

- Press while in **Measure** mode.
- Press .
- Use or to select the **LCD Setup** option.
- Press and use key to highlight the desired parameter.
- Use or to adjust the contrast / backlight or to set the desired backlight saver time.
- Press to confirm the modified options and return to the System Setup menu.

01:53:45 PM		LCD Setup	
Adjust the contrast and backlight and press <Escape>.			
Contrast	<input type="text"/>		
Backlight	<input type="text"/>		
Backlight Saver:	10 minutes		
Press <Next> to move to the next entry for edit.			
Escape	Next	<input type="button" value="Δ"/>	<input type="button" value="∇"/>

Color Palette

This option allow the user to choose a desired color palette.

To select the **Color Palette**:

- Press **SETUP** while in **Measure** mode.
- Press **System Setup**.
- Use **Δ** or **∇** to select the **Color Palette** option.

Color 1	White background blue text
Color 2	Blue background white text
Color 3	White background black text
Color 4	Black background white text

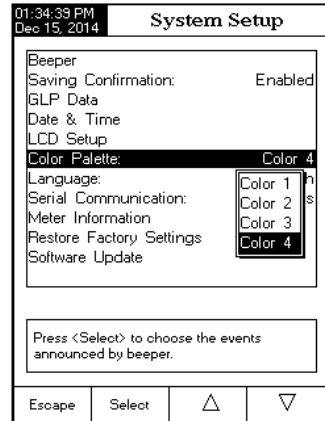

- Press **Select** and use **Δ** or **∇** to highlight the desired color.
- Press **Select** to confirm your selection and return to the System Setup menu or press **Escape** to return to the System Setup menu without changing.

Language

This option allows the user to choose the desired language in which all information will be displayed.

To select the **Language**:

- Press **SETUP** while in **Measure** mode.
- Press **System Setup**.
- Use **Δ** or **∇** to select the **Language** option.
- Press **Select** and use **Δ** or **∇** to highlight the desired language.
- Press **Select** to confirm your selection and return to the System Setup menu or press **Escape** to return to the System Setup menu without changing.



Serial Communication

This option allows the user to set the desired speed for the serial communication (baud rate) in bps. The meter and the PC program must have the same baud rate.

To set the **Serial Communication**:

- Press **SETUP** while in **Measure** mode.
- Press **System Setup**.
- Use **Δ** or **∇** to select the **Serial Communication** option.
- Press **Select** and use **Δ** or **∇** to highlight the desired baud rate.
- Press **Select** to confirm your selection and return to the System Setup menu or press **Escape** to return to the System Setup menu without changing.



Meter Information

This option provides general information about the instrument serial number (each instrument has a unique identification serial number), the software version and the factory calibration date and time (for mV and temperature).

Note: All instruments are factory calibrated for mV and temperature for Channel 1 and resistance and temperature for Channel 2. One year after factory calibration, a warning message starting "Factory Calibration Expired" will be displayed when powering up the instrument. The instrument will still function, however, it should be taken to the nearest Hanna Customer Service for factory calibration.

To view the **Meter Information**:

- Press **SETUP** while in **Measure** mode.
- Press **System Setup**.
- Use **Δ** or **∇** to select the **Meter Information** option.
- Press **Select** to access the **Meter Information** menu.
- Press **Escape** to return to the System Setup menu.

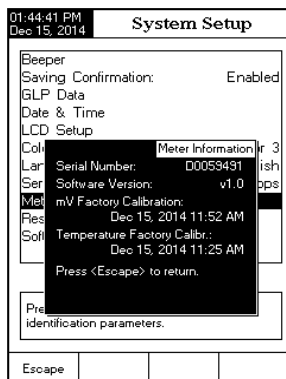

Restore Factory Settings

This option allows the user to erase all user settings and reset the instrument to the default factory settings.

To restore the **Factory Settings**:

- Press **SETUP** while in **Measure** mode.
- Press **System Setup**.
- Use **▲** or **▼** to select the **Restore Factory Settings** option.
- Press **Select** to confirm your selection. A pop-up menu will be displayed, asking for confirmation.
- Press **Yes** to confirm your selection and return to the System Setup or press **No** to return to the System Setup menu without restoring defaults.
- Press **Escape** to return to **Measure** mode.

Software update

This function allows the user to update instrument software. In order to start the PC upgrade application, you need to select the proper baud rate, the software update package and start the update.

- Press **Channel** while in **Measure** mode to access channel selection menu. Four available options will be displayed: Channel 1, Channel 2 or multi-channel with the first or the second channel highlighted. The “Choose Channel Configuration” message is displayed in the Reminder messages area.
- Select the desired option by pressing the appropriate key: **Channel 1**, **Channel 2**, **Channel 1** or **Channel 2**. The instrument will display in the selected option **Measure** mode.

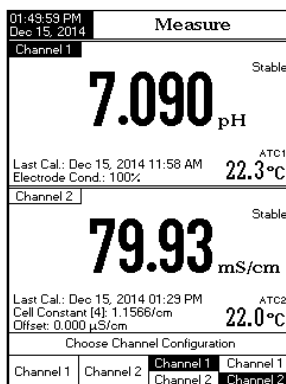
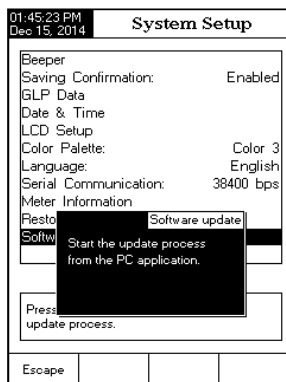
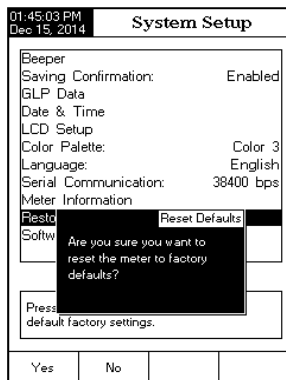

The **pH Setup** menu allows the user to set the parameters associated with pH measurement and calibration.

pH can be set for Channel 1 only.

Accessing pH Setup

- Press **MODE** while in **Measure** mode and then **pH** to select pH range for the desired channel.
- Press **SETUP** and then **pH Setup** to access **pH Setup** menu.

To access a **pH Setup** option:

- Use **Δ** or **∇** to highlight the desired option.
- Press **Select** to access the selected option.

The following is a detailed description of the **pH Setup** option screens.

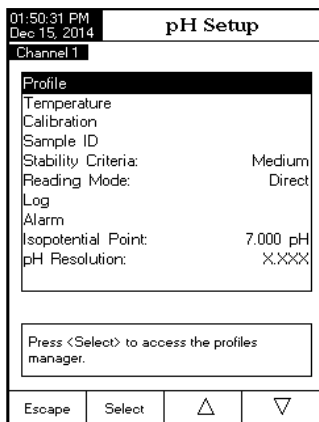

Profile

This option opens the **Profile** manager. Enabling **Profile** allows the user to Save, Load or Delete an application **Profile**. The **Profile** option allows the user to store up to ten separate profile applications (five profiles for each channel). Each **Profile** can be named and recalled at a moment's notice. A profile is a sensor setup complete with measurement units, logging and display preferences, calibration standards (Buffer or Standards including custom), setup of the Display screen for measurement (i.e. single, dual, graphing, GLP) and any other sensor configuration. Once saved, the exact same profile can be used at another time. This is a handy feature if the meter is used occasionally for additional applications because it saves time in the setup of the meter and ensures that the same procedure will be used.

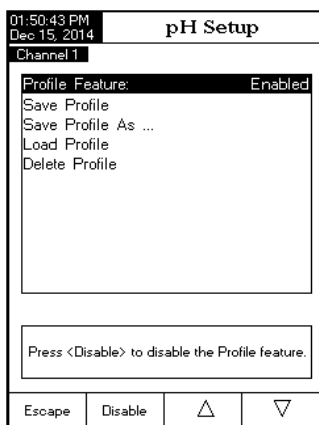

To save the measurement configuration for pH mode:

- Press **pH Setup** and use **Δ** or **∇** to highlight **Profile**.
- Press **Enable** / **Disable** to enable / disable this feature.

The available options are:

Save Profile: save the current profile.











Save Profile As...: save current profile using a specific name.

Load Profile: load from available profiles.

Delete Profile: delete a profile.

Save Current Profile

To save the current profile:

- Use  or  to select **Save Profile** or **Save Profile As...**
- Press . The Text Editor box will be displayed on the LCD.
- Enter the desired profile name by using  and  to highlight the desired character and then press  to add it to the text bar. It is also possible to delete the last character by positioning the cursor on the Backspace character () and pressing .
- Press  to return to the Profile options.
- Use **Save Profile** to save changes made to a presently used Profile. Changes will overwrite existing configurations.
- Select **Load Profile** to select a profile to use from the list of saved profiles. Highlight the desired profile and press .
- Select **Delete Profile** to remove a selected profile from the saved list. Highlight the profile and press .

Temperature

The temperature has a direct influence on pH. This option allows the user to choose the temperature source and units, as well as the desired manual temperature for manual temperature compensation mode.

Temperature Source

If using a temperature probe, Automatic Temperature Compensation will be performed relative to the displayed temperature, with the "ATC" indicator displayed on the LCD. A single temperature probe can be used for both measurement channels if desired. Select the source by selecting Manual, Channel 1 or Channel 2. If no temperature probe is detected, Manual Temperature Compensation will be performed, with the "MTC" indicator on the LCD.

Temperature Unit

The desired temperature unit can be chosen (Celsius, Fahrenheit or Kelvin degrees) and the meter will automatically make the conversion for the selected unit.

Manual Temperature

If no temperature probe is connected, the desired temperature can be set manually. The default setting is 25.0 °C. If the measured temperature is different, the value can be manually adjusted to obtain an accurate pH measurement.

To set one of the **Temperature** options:

- Press **SETUP** while in **pH Measure** mode.
- Press **pH Setup**.
- Use **Δ** or **∇** to select the **Temperature** option.
- Press **Select** and use **Δ** or **∇** to highlight the desired **Temperature** option you wish to modify.
- Press **Select** and use **Δ** or **∇** to highlight the desired option (for Temperature Source & Unit options) or use **Δ** or **∇** to adjust the temperature value between the displayed limits (for Manual Temperature option).
- Press **Select** to confirm your selection (for Temperature Source & Unit options) or press **Accept** to save the current value (for Manual Temperature option). Otherwise, press **Escape** to cancel operation.

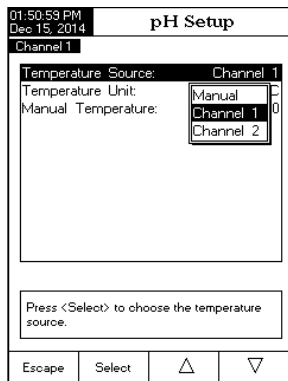

Calibration

This option allows the user to setup desired parameters related to the calibration.

Buffer Entry Type

Three settings are available for the pH buffers used for electrode calibration:

Automatic - the instrument automatically selects the closest buffer to the measured pH value from the predefined buffers chosen in the option **Edit Buffer Group**.

Semiautomatic - the instrument automatically selects the closest buffers to the measured pH value from all available buffers and you can choose the one used, from standard and custom buffers.

Manual Selection - the desired pH buffer is manually selected from all available buffers (standard and custom).

To set the **Buffer Entry Type**:

- Press **SETUP** while in **pH Measure** mode.
- Press **pH Setup**.
- Use **Δ** or **∇** to select the Calibration option.

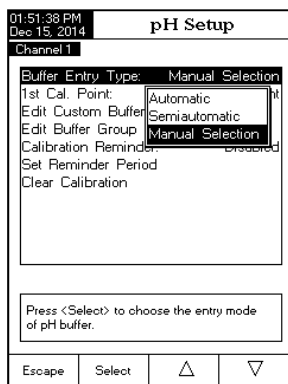

- Press **Select** and use **Δ** or **∇** to highlight the **Buffer Entry Type** option.
- Press **Select** and use **Δ** or **∇** to highlight the desired option.
- Press **Select** to confirm your selection or press **Escape** to cancel operation.

1st Cal. Point

Two options are available for the **1st Cal. Point** parameter: Point and Offset.

Point: A new buffer can be added to an existing calibration. The electrode slope will be reevaluated with the addition of this buffer (normal operation).

Offset: The new buffer calibration point can create a constant offset to all existing pH calibration data (existing calibration must have a minimum of two pH buffers).

To set the **1st Cal. Point**:

- Press **SETUP** while in **pH Measure** mode.
- Press **pH Setup**.
- Use **Δ** or **∇** to select the Calibration option.
- Press **Select** and use **Δ** or **∇** to highlight the **1st Cal. Point** option.
- Press **Point** / **Offset** as desired.
- Press **Escape** to return to previous menu.

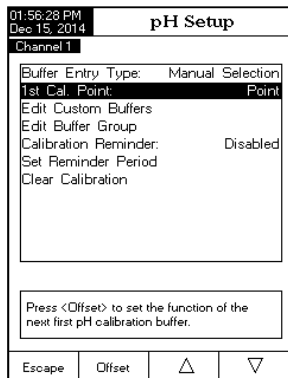

Edit Custom Buffers

If special custom pH buffers are required during calibration, the **Edit Custom Buffers** option is available. Up to five pH custom buffers can be added. If a custom buffer is used, the user must verify it's value at the temperature of calibration.

To edit/set the **Custom Buffers**:

- Press **SETUP** while in **pH Measure** mode.
- Press **pH Setup**.
- Use **Δ** or **∇** to select the Calibration option.
- Press **Select** and use **Δ** or **∇** to highlight the **Edit Custom Buffers** option.
- For a previous set value, press **Invalidate Buffer** to set the custom buffer value to "----" if desired and confirm the setting by pressing **Yes**, otherwise press **Edit Buffer** to edit the selected custom buffer.
- While in edit custom buffer menu press **Reset Buffer** to set the custom buffer value to 7.000 pH and then use **Δ** or **∇** to set the desired custom buffer value.

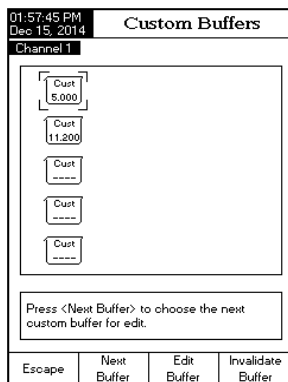

- Press **Escape** to exit custom buffer edit menu. If the Saving Confirmation is enabled, press **Yes** to accept the modified option, **No** to escape without saving or **Cancel** to return to the editing mode. Otherwise, the modified option is saved automatically.
- Use **Next Buffer** key to select the next custom buffer to be set or press **Escape** to return to Calibration options.

Edit Buffer Group

Accessing this option, the user can edit the desired group of five pH buffers for automatic buffer recognition (Automatic Buffer Entry Type). If the Buffer Group already contains five pH buffers, at least one pH buffer has to be removed in order to add another buffer.

To edit/set the **Buffer Group**:

- Press **SETUP** while in **pH Measure** mode.
- Press **pH Setup**.
- Use **Δ** or **∇** to select the Calibration option.
- Press **Select** and use **Δ** or **∇** to highlight the **Edit Buffer Group** option.
- Press **Select** and use **▶** and **∇** to choose the pH buffer to be included in the buffer group.
- Press **Add** or **Remove** to add/remove the selected pH buffer to/from the buffer group.
- Press **Escape** to return to Calibration options and to save the changes.

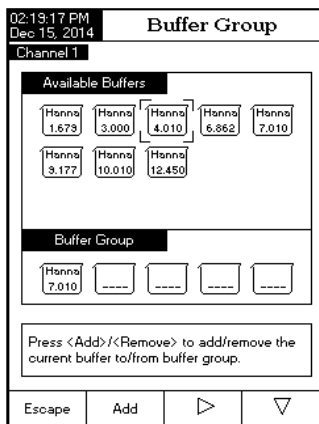

Calibration Reminder

This option allows the user to select a calibration reminder schedule. Three options are available for the calibration reminder: Daily, Periodic or Disabled.

To set the **Calibration Reminder**:

- Press **SETUP** while in **pH Measure** mode.
- Press **pH Setup**.
- Use **Δ** or **∇** to select the Calibration option.
- Press **Select** and use **Δ** or **∇** to highlight the **Calibration Reminder** option.
- Press **Select** and use **Δ** or **∇** to highlight the desired option.
- Press **Select** to confirm your selection or press **Escape** to cancel operation.

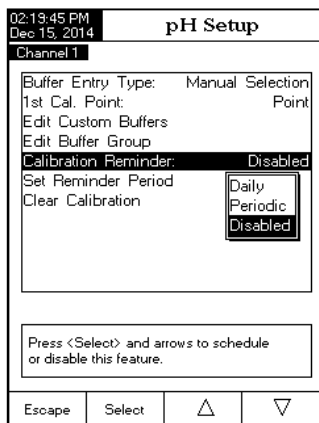

Set Reminder Period

Schedule the calibration reminder timing with this option (verify Daily or Periodic is set for Calibration Reminder).

If a Daily reminder is desired, set the time of day you wish the reminder to occur.

If a Periodic reminder is desired, schedule time in days, hours and/or minutes after the last calibration for the reminder to occur.

To set the **Reminder Period**:

- Press **SETUP** while in **pH Measure** mode.
- Press **pH Setup**.
- Use **Δ** or **∇** to select the Calibration option.
- Press **Select** and use **Δ** or **∇** to highlight the **Set Reminder Period** option.
- Press **Select** and use **Next** / **Previous** to select next/previous entry to be edited.
- Press **Edit** and use **Δ** or **∇** to set the desired value, then press **Accept** to save the modified value.
- Press **Escape** to return to the Calibration options. If the Saving Confirmation is enabled, press **Yes** to accept the modified option, **No** to escape without saving or **Cancel** to return to the editing mode. Otherwise, the modified option is saved automatically.

02:20:08 PM Dec 15, 2014	Periodic Reminder		
Channel 1			
Enter the time period that must be passed since the last calibration before the time reminder will appear.			
days	hours	minutes	
00	01	00	
Press <Escape> to exit to previous screen. Press <Edit> to edit the focused entry. Press <Next> or <Previous> to select entry.			
Escape	Edit	Next	Previous

Clear Calibration

This feature deletes the pH electrode calibration. A default pH calibration will replace the actual electrode calibration until a new electrode calibration is made.

To clear **Calibration**:

- Press **SETUP** while in **pH Measure** mode.
- Press **pH Setup**.
- Use **Δ** or **∇** to select the Calibration option.
- Press **Select** and use **Δ** or **∇** to highlight the **Clear Calibration** option.
- Press **Select** to clear calibration. A pop-up menu will be displayed asking for confirmation (when a calibration is available).
- Press **Yes** to confirm or press **No** to escape without saving and return to the Calibration options.

02:20:22 PM Dec 15, 2014	pH Setup		
Channel 1			
Buffer Entry Type:	Manual Selection		
1st Cal. Point:	Point		
Edit Custom Buffers			
Edit Buffer Group			
Calibration Reminder:	Periodic		
Set Reminder Period			
Clear Calibration			
Press <Select> to clear the calibration.			
Escape	Select	Δ	∇

Sample ID

This option allows the user to assign an identification number/name. Two Sample ID options are available: ID Increment and Edit Sample ID.

ID Increment

Two choices are available for the sample ID:

None - the sample ID will be fixed and it can be entered alphanumerically (see Edit Sample ID).

Automatic - the sample ID will automatically increment by one for each new log lot.

To set the **ID Increment** mode:

- Press **SETUP** while in **pH Measure** mode.
- Press **pH Setup**.
- Use **Δ** or **∇** to select the **Sample ID** option.
- Press **Select** and use **Δ** or **∇** to highlight the **ID Increment** option.
- Press **None** / **Automatic** as desired.
- Press **Escape** to return to previous menu.

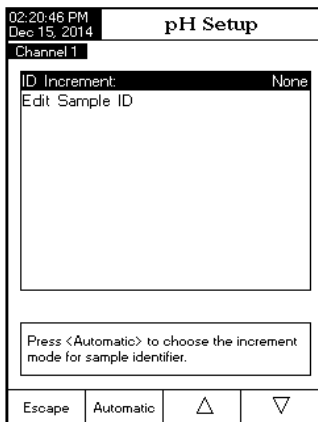

Edit Sample ID

This option allows the user to edit the sample ID.

Note: The ID Increment mode must be set to None, to use this feature.

To edit the **Sample ID**:

- Press **SETUP** while in **pH Measure** mode.
- Press **pH Setup**.
- Use **Δ** or **∇** to select the **Sample ID** option.
- Press **Select** and use **Δ** or **∇** to highlight the **Edit Sample ID** option.
- Press **Select** to confirm your selection.
- If the selected increment is None, the Text Editor menu will be displayed on the LCD, allowing you to enter the desired sample number/name by accepting the highlighted character which is added in the text bar, using **Select**. The **▶** and **∇** keys help the user to select the desired character.

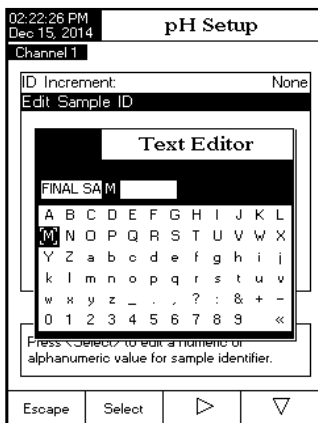

It is also possible to delete the last character; position the cursor on the Backspace character and press **Select**.

- Press **Escape** to return to Sample ID options. If the Saving Confirmation is enabled, press **Yes** to accept the modified option, **No** to escape without saving or **Cancel** to return to the editing mode. Otherwise, the modified options are saved automatically.
- If the selected increment mode is Automatic, the desired sample ID value can be set using **Δ** or **∇**.
- Press **Accept** to save the current value or press **Escape** to cancel operation.

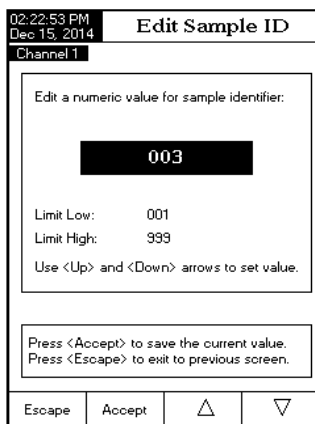

Stability Criteria

This option allows the user to select the signal stability criterion for the measured parameter (pH, mV, ISE):

Fast - this setting will give faster results with less accuracy.

Medium - this setting will give medium speed results with medium accuracy.

Accurate - this setting will give slower results with high accuracy.

To set the **Stability Criteria**:

- Press **SETUP** while in **pH Measure** mode.
- Press **pH Setup**.
- Use **Δ** or **∇** to select the **Stability Criteria** option.
- Press **Select** and use **Δ** or **∇** to highlight the desired option.
- Press **Select** to confirm your selection or press **Escape** to cancel operation.

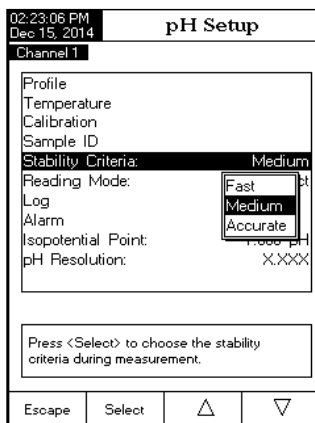

Reading Mode

This option allows the user to select between Direct and Direct/AutoHold pH mode.

Direct - the current reading is displayed in realtime on the LCD.

Direct/AutoHold - the current reading can be frozen on the LCD when **AutoHold** is pressed and the stability criterion is reached.

To set the **Reading Mode**:

- Press **SETUP** while in **pH Measure** mode.
- Press **pH Setup**
- Use **Δ** or **∇** to select the **Reading Mode** option.
- Press **Direct** / **AutoHold** to select Direct / AutoHold option as desired.
- Press **Escape** to cancel operation.

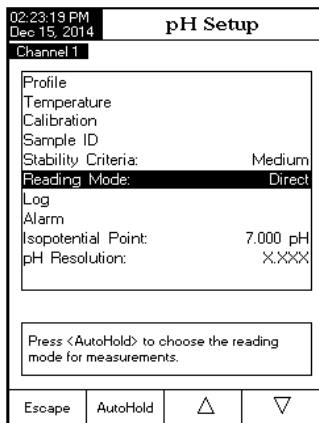

Log

Note: See Logging section for available types of logging.

This option allows the user to edit the log settings: Logging Type, Logging Data Configuration, Sampling Period and New Lot.

Logging Type

Three logging types are available: Automatic, Manual and AutoHold.

Automatic - the measurement data is logged automatically at constant time intervals;

Manual - a snapshot of the displayed measurement data is logged with time stamp when the user manually depresses Log;

AutoHold - this is configured along with the Direct/AutoHold Reading Mode to take a snapshot of stable measurement data. Press **Start Log** to initiate a logging session. Press **Auto Hold** to initiate an Auto Hold event. The log occurs automatically once measurement stability is reached. This type log removes subjective data, as it only captures stable measurements.

To set the **Logging Type**:

- Press **SETUP** while in **pH Measure** mode.
- Press **pH Setup**
- Use **Δ** or **∇** to select the Log option.
- Press **Select** and use **Δ** or **∇** to highlight the **Logging Type** option.
- Press **Select** and use **Δ** or **∇** to highlight the desired option.
- Press **Select** to confirm your selection or press **Escape** to cancel operation.

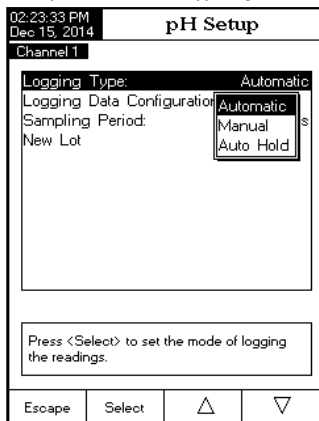

Logging Data Configuration

This option allows the user to select which parameters will accompany a log File: Date/Time, Calibration Data, Sample ID, Instrument ID, Operator ID, Company Name, Additional Info 1 and Additional Info 2.

To set the **Logging Data Configuration**:

- Press **SETUP** while in **pH Measure** mode.
- Press **pH Setup**.
- Use **Δ** or **∇** to select the Log option.
- Press **Select** and use **Δ** or **∇** to highlight the **Logging Data Configuration** option.
- Press **Select** and use **Δ** or **∇** to highlight the desired parameter to be logged in file.
- Press **Yes** to enable the parameter or **No** to disable it.
- Press **Escape** to return to previous menu.

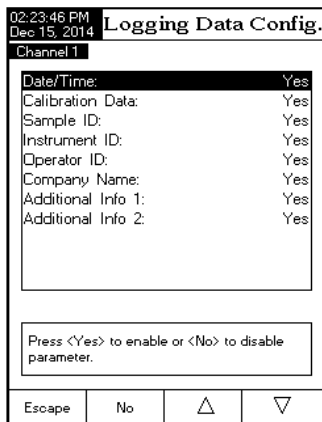

Sampling Period

This option allows the user to select the desired sampling period for automatic logging type.

To set the **Sampling Period**:

- Press **SETUP** while in **pH Measure** mode.
- Press **pH Setup**.
- Use **Δ** or **∇** to select the Log option.
- Press **Select** and use **Δ** or **∇** to highlight the **Sampling Period** option.
- Press **Select** and use **Δ** or **∇** to select the desired option.
- Press **Select** to confirm your selection or press **Escape** to cancel operation.

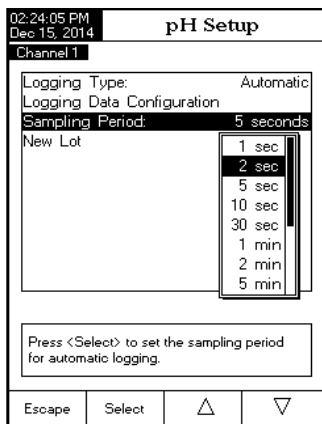

New Lot

This option is used to create a new lot when manual logging is used.

Note: If New Lot option is accessed and the Logging Type is Automatic, a warning message appears on the LCD informing the user that a new lot can be created only if the Logging Type is set as Manual.

To generate a **New Lot**:

- Press **SETUP** while in **pH Measure** mode.
- Press **pH Setup**.
- Use **Δ** or **∇** to select the **Log** option.
- Press **Select** and use **Δ** or **∇** to highlight the **New Lot** option.
- Press **Select** to generate a new manual lot. A pop-up menu will be displayed asking for confirmation.
- Press **Yes** to confirm or press **No** to escape without saving and return to the **Log** options.

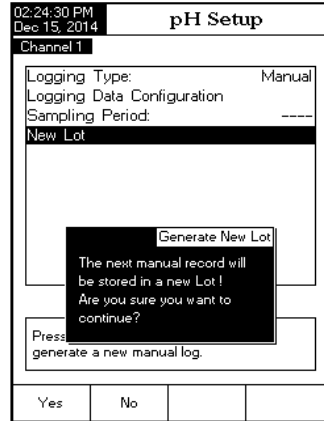

Alarm

This option allows the user to select the alarm settings:

Alarm State and **Alarm Limits**. If the **Alarm** option is enabled, a continuous double beep will be heard, along with the "Alarm" indicator blinking on the LCD, each time the set limits in **Measure** mode are exceeded.

Note: Alarm Beeper must be set On for audible beep to be heard.

See: System Setup > Beeper > Alarm.

Alarm State

Three settings are available for the **Alarm State** option:

Disabled - the alarm will be disabled.

Inside Limits - the alarm state will trigger when the measured value is inside the set limits.

Outside Limits - the alarm state will trigger when the measured value is outside the set limits.

To set the **Alarm State**:

- Press **SETUP** while in **pH Measure** mode.
- Press **pH Setup**.
- Use **Δ** or **∇** to select the **Alarm** option.
- Press **Select** and use **Δ** or **∇** to highlight the **Alarm State** option.
- Press **Select** and use **Δ** or **∇** to highlight the desired option.
- Press **Select** to confirm your selection or press **Escape** to cancel operation.

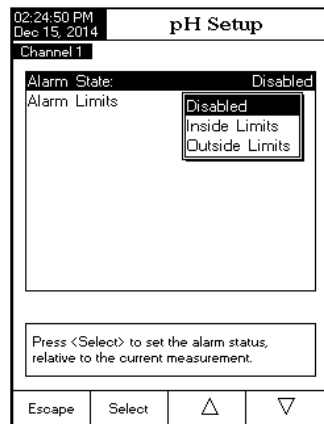

Alarm Limits

This option allows the user to set the alarm limits for the measured value.

Note: The Alarm High value can not be lower than the Alarm Low value.

To set the **Alarm Limits**:

- Press **SETUP** while in **pH Measure** mode.
- Press **pH Setup**.
- Use **△** or **▽** to select the **Alarm** option.
- Press **Select** and use **△** or **▽** to highlight the **Alarm Limits** option.
- Press **Select** and use **Next** / **Previous** to select next/previous entry to be edited.
- Press **Edit** and use **△** or **▽** to set the desired value, then press **Accept** to save the modified value.
- Press **Escape** to return to the Alarm options. The modified option is saved automatically.

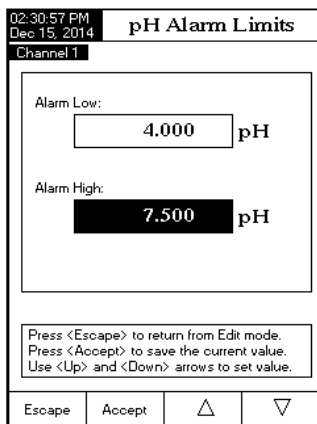

Isopotential Point

This option allows the user to edit the isopotential point of the electrode used for pH measurements. The isopotential point is the mV reading for an electrode at which temperature has no effect on the measurement. The ideal electrode has an isopotential point of 0.0 mV and 7.00 pH, while an actual electrode typically deviates slightly from the ideal values.

If the actual isopotential pH for an electrode is known, it can be set by accessing this option.

Note: If the isopotential point has been modified, recalibration must be performed.

To set the **Isopotential Point**:

- Press **SETUP** while in **pH Measure** mode.
- Press **pH Setup**.
- Use **△** or **▽** to select the **Isopotential Point** option.
- Press **Select** and set the desired isopotential pH value using **△** or **▽**.
- Press **Accept** to save the current value or press **Escape** to cancel operation.

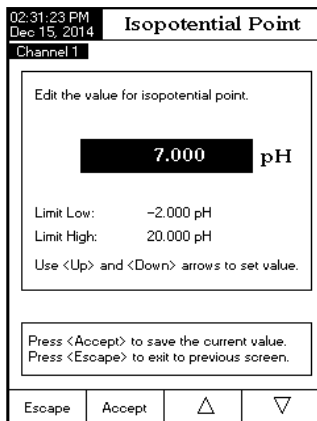

pH Resolution

Select the desired pH resolution with this option. Choose from one (X.X), two (X.XX) or three (X.XXX) digits displayed past the decimals.

To set the **pH Resolution**:

- Press **SETUP** while in **pH Measure** mode.
- Press **pH Setup**.
- Use **Δ** or **∇** to select the **pH Resolution** option.
- Press **Select** and use **Δ** or **∇** to highlight the desired option.
- Press **Select** to confirm your selection or press **Escape** to cancel operation.

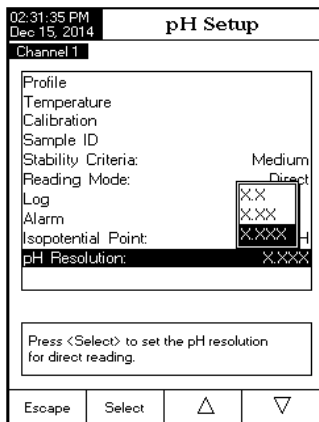

The **mV Setup** menu allows the user to set the parameters associated with mV and Relative mV measurements.

Accessing mV Setup

- Press **MODE** while in **Measure** mode and then **mV** or **Rel mV** to select mV / Rel mV range for the desired channel.
- Press **SETUP** and then **mV Setup** to access **mV Setup** menu.

To access a **mV Setup** option:

- Use **Δ** or **∇** to highlight the desired option.
- Press **Select** to access the selected option.

The following is a detailed description of the **mV Setup** option screens.

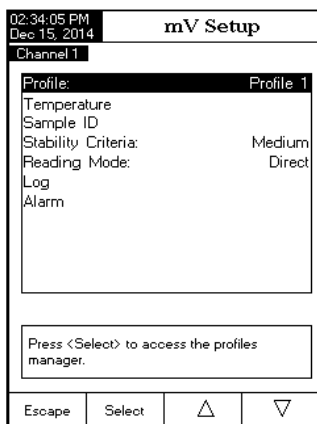

Profile - See **pH Setup** section.

Temperature

ORP measurements are not temperature compensated, although ORP values can change with temperature (e.g. reference electrode potential changes, sample equilibrium changes). It is important to report ORP values together with the reference electrode used and the temperature of measurement.

This option permits selection of the temperature source and measurement units.

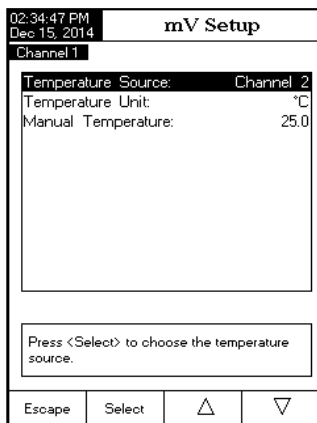

Temperature Source

If using a temperature probe, sample temperature will be displayed with the “ATC” indicator displayed on the LCD. The ATC option can be selected from Channel 1 or Channel 2. If no temperature probe is detected, a manually set value will be displayed (and logged) with the measurement.

Temperature Unit

Select the desired temperature unit (Celsius, Fahrenheit or Kelvin degrees) and the Meter will automatically convert to the selected unit.

Manual Temperature

If no temperature probe is connected, the desired temperature can be manually entered. The default setting is 25.0 °C.

Calibration (Relative mV only)

Calibration Reminder

This option allows the user to select a calibration reminder schedule if desired.

See pH Setup section > Calibration Reminder section for option access details.

Set Reminder Period

See pH Setup section > Set Reminder Period section.

Clear Calibration

This feature deletes the Relative mV calibration for the selected channel.

- Press **SETUP** while in Rel mV mode.
- Press **mV Setup** then use **△** or **▽** to access Calibration option.
- Press **Select** and use **△** or **▽** to highlight **Clear Calibration** option.
- Press **Select** to clear calibration. A pop-up menu will be displayed asking for confirmation (when a calibration is available).
- Press **Yes** to confirm or press **No** to escape without saving and return to the Calibration options.

Sample ID - See pH Setup section.

Stability Criteria - See pH Setup section.

Reading Mode - See pH Setup section.

Log - See Logging section or pH Setup section.

Alarm - See pH Setup section.

The **ISE Setup** menu allows the user to set the parameters regarding ISE measurement and calibration.

Accessing ISE Setup

- Press **MODE** while in **Measure** mode and then **ISE** to select ISE range for the desired channel.
- Press **SETUP** and then **ISE Setup** to access **ISE Setup** menu.

To access an **ISE Setup** option:

- Use **△** or **▽** to highlight the desired option.
- Press **Select** to access the selected option.

The following is a detailed description of the **ISE Setup** option screens.

02:35:11 PM Dec 15, 2014		ISE Setup	
Channel 1			
Profile:	Profile 1		
Reading Mode:	Direct		
Temperature Calibration			
Electrode Type:	Fluoride		
Concentration Unit:	ppm		
Sample ID			
Stability Criteria:	Medium		
Log			
Alarm			
ISE Significant Digits:	XXX		
Press <Select> to access the profiles manager.			
Escape	Select	△	▽

Profile - See **pH Setup** section.

Reading Mode

This option allows the user to select the desired reading mode: Direct, Direct/AutoHold, Known Addition, KnownSubtraction, Analyte Addition and Analyte Subtraction. Four of these Reading Modes are collectively known as Incremental Methods (see ISE Theory section for details). Direct measurements and Direct/AutoHold measurements are also possible.

Direct

Direct measurements are analogous to taking pH measurements. The ISE is calibrated in ion standards and sample measurements are made directly. The ISE's manual should be consulted for tips and practices of making **Direct** measurements. The ion concentration can be read directly from the instrument.

Direct/AutoHold

Direct/AutoHold measurements are made similar to **Direct** measurements. The advantage of using **AutoHold** is a measurement that has not reached equilibrium will not be used. Only after the chosen stability criteria has been met will the meter go into the **AutoHold** mode. Using **AutoHold** removes the subjective nature of stability.

Known Addition

In the **Known Addition** method, a sample is measured with an ISE before and after the addition of a known volume of a standard. The mV difference is then used to calculate the concentration of the Ion in the original sample.

Known Subtraction

In the **Known Subtraction** method, a sample is measured with an ISE before and after the addition of a known volume of a reactant standard. The reactant standard reacts with the measured ion in the sample, reducing its concentration. The mV difference is then used to calculate the concentration of the ion in the original sample. The stoichiometric ratio between reactant standard and ion in the sample must be known.

Analyte Addition

Analyte Addition is similar to the **Known Addition** method, with the difference being that an aliquot of sample is added to a known volume of standard. Both solutions contain the same measured ion. The standard is measured with an ISE before and after the addition of a known volume of a sample. The ion concentration is then calculated using the difference in mV potential. The sample should increase the concentration of the ion being measured.

Analyte Subtraction

In the **Analyte Subtraction** method, an aliquot of sample is added to a reactant standard of known concentration and volume. The sample partially reacts with the measured ion. The stoichiometric ratio between standard and sample must be known. The ion concentration is then calculated using the difference in mV potential.

To set the **Reading Mode**:

- Press **SETUP** while in ISE Measure mode.
- Press **ISE Setup**.
- Use **Δ** or **∇** to select the **Reading Mode** option.
- Press **Select** and use **Δ** or **∇** to highlight the desired option.
- Press **Select** to confirm your selection or press **Escape** to cancel operation.

02:37:02 PM Dec 15, 2014		ISE Setup	
Channel 1			
Profile:	JANE		
Reading Mode:	Direct		
Temperature	Direct		
Calibration	Direct/Auto-Hold		
Electrode Type:	Known Addition		
Concentration Unit:	Known Subtraction		
Sample ID	Analyte Addition		
Stability Criteria:	Analyte Subtraction		
Log			
Alarm			
ISE Significant Digits:	XXX		
Press <Select> to choose the reading mode for ISE concentration measurements.			
Escape	Select	Δ	∇

Temperature

This option permits the user to configure all parameters related to ISE temperature measurements.

Temperature Source

The options are Manual, Channel 1 or Channel 2. If no temperature probe is detected, a manually set value will be displayed (and logged) with the measurement. If a temperature probe is connected to either channel, it may be selected. The temperature measurement will be displayed and logged with the measurement and may be used for temperature compensation calculation if Temperature Compensation is enabled.

02:37:27 PM Dec 15, 2014		ISE Setup	
Channel 1			
Temperature Source:	Channel 2		
Temperature Unit:	°C		
Manual Temperature:	25.0		
Temperature Compensation:	Enabled		
Isopotential Point:	20.0 ppm		
Press <Select> to set the isopotential point value.			
Escape	Select	△	▽

Temperature Unit

Select the desired temperature unit (Celsius, Fahrenheit or Kelvin degrees) and the meter will automatically convert to the selected unit.

Manual Temperature

If no temperature probe is connected, the desired temperature can be set manually. The default setting is 25.0 °C. If the measured temperature is different, the value can be manually adjusted to obtain an accurate ion measurement.

Temperature Compensation

ISE measurements benefit from temperature compensated corrections if:

- standards and sample temperatures differ from each other.
- the Isopotential Point of the ISE is known.

If sample and standards are made at the same temperature, leave this option disabled.

Isopotential Point

If the Temperature Compensation is enabled, the isopotential point of the ISE must be added in this parameter. Verify the Electrode Type and Concentration Unit are configured for the desired application. The **Isopotential point** will use the selected concentration unit. Use and to edit the isopotential point value and press to save the value or press to cancel operation.

Notes: A warning message will appear on the LCD informing the user to perform a new calibration.

A minimum of two ion standards is required for the ISE calibration.

02:37:38 PM Dec 15, 2014		Isopotential Point	
Channel 1			
Edit the value for isopotential point.			
20.0 ppm			
Limit Low:	5.00E-3 ppm		
Limit High:	1.00E+5 ppm		
Use <Up> and <Down> arrows to set value.			
Escape	Accept	△	▽

Calibration

This option allows the user to view and configure all ISE parameters related to ISE calibration.

Manual Entry

Two different standard groups can be used for calibration of ISE:

All Standards - During calibration the user can select the desired standards from a large list containing all the predefined standards values and the custom standards.

Group Standards - the user can pre-select a group of standards from the existent group of standards to be used during sensor calibration.

To set the **Manual Entry**:

- Press **SETUP** while in **ISE Measure** mode.
- Press **ISE Setup**.
- Use **Δ** or **∇** to select the Calibration option.
- Press **Select** and use **Δ** or **∇** to highlight the **Manual Entry** option.
- Press **All** or **Group** to select the desired option.

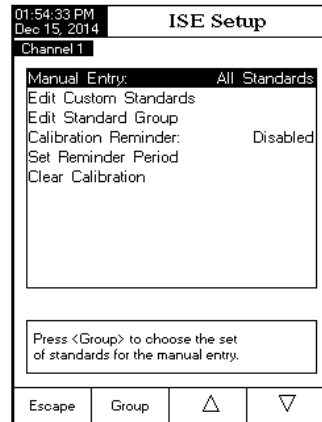

Edit Custom Standards

Use **Edit Custom Standards** function to add additional ISE standard values. Up to five custom standard values can be added. Set Electrode Type and Concentration Unit prior to adding these standards.

To edit/set the **Custom Standards**:

- Press **SETUP** while in **ISE Measure** mode.
- Press **ISE Setup**.
- Use **Δ** or **∇** to select the Calibration option.
- Press **Select** and use **Δ** or **∇** to highlight the **Edit Custom Standards** option.
- If you want to disable the custom standard, press **Invalidate Standard**. A pop-up menu will be displayed asking for confirmation. Press **Yes** to confirm (the custom standard value will turn to "----") or press **No** to cancel the operation.
- Use **Next Standard** key to select the next custom standard to be set.
- Press **Escape** to return to Edit Custom Standard options.

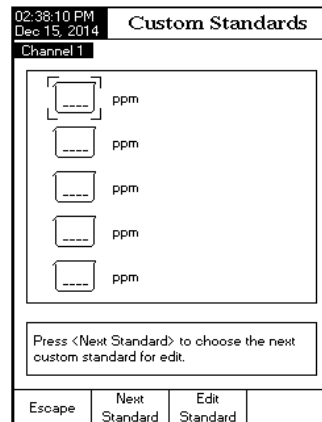

Edit Standard Group

If a Group Standard was selected in the parameter Manual Entry, this parameter is used to create your group of standards. If the Standard Group already contains five ISE standards, at least one ISE standard has to be removed in order to add another standard.

To edit/set the **Standard Group**:

- Press **SETUP** while in **ISE Measure** mode.
- Press **ISE Setup**.
- Use **Δ** or **∇** to select the Calibration option.
- Press **Select** and use **Δ** or **∇** to highlight the **Edit Standard Group** option.
- Press **Select** and use **▶** and **∇** to choose the ISE standard to be included in the standard group.
- Press **Add** / **Remove** to add/remove the selected ISE standard to/from the standard group.
- Press **Escape** to return to Calibration options and to save the changes.

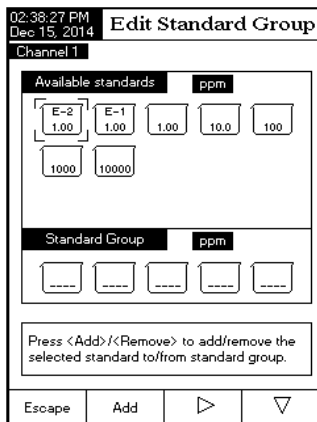

Calibration Reminder - See **Calibration option from pH Setup** section.

Set Reminder Period - See **Calibration option from pH Setup** section.

Clear Calibration - See **Calibration option from pH Setup** section.

Electrode Type

This option allows the user to select the desired Ion Selective Electrode used for measurements from a list: Ammonia, Bromide, Cadmium, Calcium, Carbon Dioxide, Chloride, Cupric, Cyanide, Fluoride, Iodide, Lead, Nitrate, Potassium, Silver, Sodium, Sulfate, Sulfide and five custom ISE. For the standard ISE it is possible to view the Ion Constants (Name, Molar Weight and Electric Charge/Slope), while for the custom ISE all these constants can be manually set.

To set the **Electrode Type**:

- Press **SETUP** while in ISE Measure mode.
- Press **ISE Setup**.
- Use **Δ** or **∇** to select the **Electrode Type** option.
- Press **Select** and use **Δ** or **∇** to select the desired standard ISE or a custom one from the list.

For standard ISE:

- Press **View** to visualize the Ion Constants and then press **Escape** at any time to exit Ion Constants view mode.
- Press **Select** to confirm your selection and return to ISE Setup options.

For custom ISE:

- Press **View** to edit the Ion Constants for the selected custom ISE. Use **Δ** or **∇** to select the desired constant and press **Select** to enter edit mode or **Escape** to cancel operation.
- For the ion Name the Text Editor menu will be displayed on the LCD. Enter the desired information by accepting the highlighted character which is added in the text bar, using **Select**. The **▶** and **∇** keys help the user to select the desired character. It is also possible to delete the last character by positioning the cursor on the Backspace character and pressing **Select**. Press **Escape** to return to the Ion Constants menu. If the Saving Confirmation is enabled, press **Yes** to accept the modified option, **No** to escape without saving or **Cancel** to return to the editing mode. Otherwise, the modified option is saved automatically.
- To set the appropriate ion molar weight (in g/mol units) use **Δ** or **∇** to set the desired value and then press **Accept** to save the current value or press **Escape** to cancel operation.

02:51:04 PM Dec 15, 2014	Electrode Type
Channel 1	
Ammonia Bromide Cadmium Calcium Carbon Dioxide Chloride Cupric Cyanide Fluoride Iodide Lead	
Press <View> to display Ion parameters. Press <Select> to use selected electrode.	
View	Select Δ ∇

02:53:42 PM Dec 15, 2014	Ion Constants
Channel 1	
Name:	Custom1
Molar Weight:	10.000 g/mol
Ion Charge/Slope:	-1 / -59.16
Press <Select> to set the value for the ion molar weight in g/mol unit.	
Escape	Select Δ ∇

02:53:56 PM Dec 15, 2014	Ion Molar Weight
Channel 1	
Set the value for Ion molar weight.	
10.000 g/mol	
Limit Low:	0.001 g/mol
Limit High:	1000.000 g/mol
Use <Up> and <Down> arrows to set value.	
Press <Accept> to save the current value. Press <Escape> to exit to previous screen.	
Escape	Accept Δ ∇

- To select the appropriate Ion Charge/Slope use Δ or ∇ and then press **Select**. If the ion electric charge is None, its slope can be manually set by pressing **Edit**.

A pop-up menu will be displayed on the LCD, in which the slope value can be set using Δ or ∇ . Press **Accept** to save the modified value or press **Escape** to return to the previous menu.

Note: If an ISE calibration was performed and a different Ion Selective Electrode is selected (standard or custom), a warning message appears on the LCD informing the user to perform a new calibration or to select the previous ISE in order to perform accurate measurements.

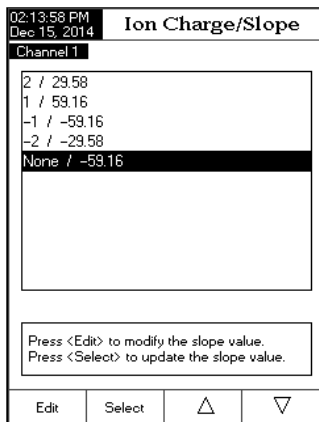

Concentration Unit

Select the desired concentration unit for the measured ion or chemical compound. The available concentration units are: ppt, g/L, ppm, mg/L, $\mu\text{g/mL}$, ppb, $\mu\text{g/L}$, mg/mL, M, mol/L, mmol/L, %w/v and User (custom unit).

To set the **Concentration Unit**:

- Press **SETUP** while in ISE Measure mode.
- Press **ISE Setup**.
- Use Δ or ∇ to select the **Concentration Unit** option.
- Press **Select** and use Δ or ∇ to highlight the desired option.
- Press **Select** to confirm your selection or press **Escape** to cancel operation.

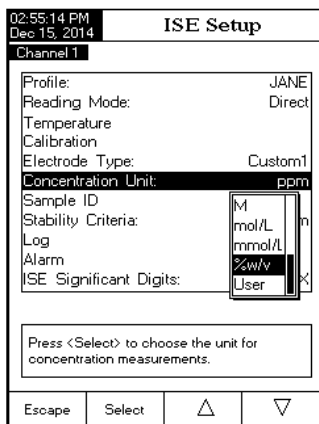

Sample ID - See **pH Setup** section.

Stability Criteria - See **pH Setup** section.

Log - See **pH Setup** section and **Logging** section.

Note: The Logging Data Configuration option includes also the Ion Constants parameter. If you want it to appear in the log reports, it must be enabled.

Alarm - See **pH Setup** section.

Note: The Alarm Limits (Low and High) are set in the selected concentration unit of the measured ion.

ISE Significant Digits

Accessing this option, the number of ISE significant digits can be set, with one (X), two (XX) or three (XXX) significant digits.

To set the **ISE Significant Digits**:

- Press **SETUP** while in ISE Measure mode.
- Press **ISE Setup**.
- Use **Δ** or **∇** to select the ISE Significant Digits option.
- Press **Select** and use **Δ** or **∇** to highlight the desired option.
- Press **Select** to confirm your selection or press **Escape** to cancel operation.

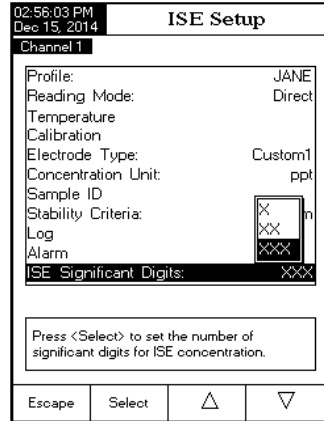

Calibrate the instrument often, especially if high accuracy is required.

The instrument should be recalibrated:

- Whenever the pH electrode is replaced.
- At least once a week.
- After testing aggressive chemicals.
- When “Electrode Cond. Unknown”, “Default Calibration” or “pH Calibration Expired” message appears on the LCD, in the Reminder messages area.

PREPARATION

Pour small quantities of the buffer solutions into clean beakers. If possible, use plastic beakers to minimize any EMC interferences.

For accurate calibration and to minimize cross-contamination, use two beakers for each buffer solution. One for rinsing the electrode and one for calibration.

If you are measuring in the acidic range, use pH 7.01 or 6.86 as first buffer and pH 4.01/3.00 or 1.68 as second buffer. If you are measuring in the alkaline range, use pH 7.01 or 6.86 as first buffer and pH 10.01/9.18 or 12.45 as second buffer.

For extended range measurements (acidic and alkaline), perform a five-point calibration by selecting five of the available buffers.

CALIBRATION PROCEDURE

There are 8 standard pH buffers that are temperature-compensated during pH calibrations: pH 1.68, 3.00, 4.01, 6.86, 7.01, 9.18, 10.01 and 12.45. If these are in the buffer group, the buffers are temperature compensated during calibration. Custom buffers require the user to use the actual buffer value at the temperature of use.

A minimum of a two-point calibration is required to determine the pH electrode condition. The buffers should bracket the sample measurement pH.

An extended pH measurement range will require calibration at multiple points. The meter is capable of calibration with 5 pH buffers. For improved measurement accuracy, perform a multiple buffer calibration bracketing and including the pH range the sample measurements.

The buffer group that will be available during calibration was set in pH setup > Calibration Buffer Entry type. The following example demonstrates pH electrode calibration if Manual selection was selected. In this case all of the 8 standard buffers will be available for calibration.

pH Calibration screen description

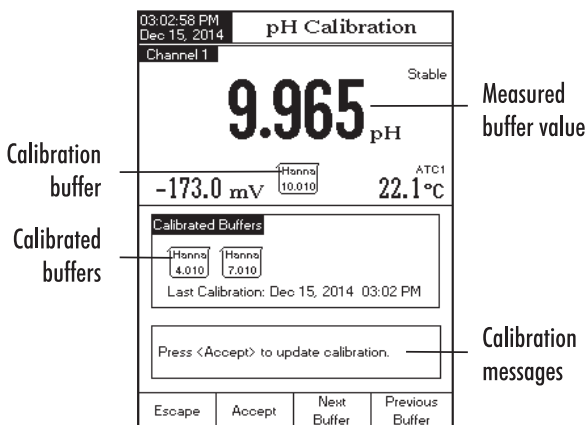





- Press . If the instrument was calibrated before and calibration was not cleared, the old calibration can be cleared by pressing . After 10 seconds, will be no longer available.

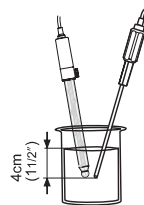



Note: It is very important to clear calibration history when a new electrode is used because most errors and warning messages that appear during calibration depend on calibration history.







- Immerse the pH electrode and the temperature probe approximately 4 cm (1½") into a buffer solution of your choice (pH 1.68, 3.00, 4.01, 6.86, 7.01, 9.18, 10.01, 12.45 or a custom buffer) and stir gently. The temperature probe should be close to the pH electrode.
- Select the pH calibration buffer used with or . The "Please wait..." message will appear on the LCD until the reading is stable or the buffer is validated.
- If the pH buffer is validated, will appear on the LCD. Press to update calibration. The calibration buffer will be added to the Calibrated Buffers section.
- Immerse the pH electrode and the temperature probe into the next buffer solution and follow the above procedure or press to exit calibration.





Notes: The new added calibration point will replace an old one if the difference between them is ± 0.2 pH.

If the existing stored calibration is full (five calibration points), a pop-up menu will be displayed on the LCD in which you can select with  or  keys the buffer you want to replace with the current buffer. Press  to delete the selected buffer and then press  to update calibration with the new buffer.

If using manual temperature, after selecting the standard buffer, press . A pop-up menu will be displayed on the LCD in which the temperature value can be adjusted using  or . Press  to save the new temperature value.

If using Custom buffers, press  after buffer has been accepted to change actual buffer conditions. A pop-up menu will be displayed on the LCD in which the custom buffer and the temperature value (MTC) can be adjusted by pressing  and then  or  keys. Press  to save the modified value and then / to select next/previous value to be adjusted.

If the Automatic buffer entry type has been selected for the calibration procedure, the instrument will automatically select the closest buffer to the measured pH value from the edit buffer group (see pH Setup for details).

If the Semiautomatic buffer entry type has been selected for the calibration procedure, the instrument will display only the closest buffers to the measured pH value from all the available buffers and the user must select with  or  the buffer being used.

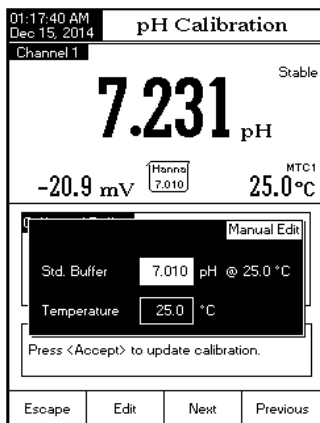
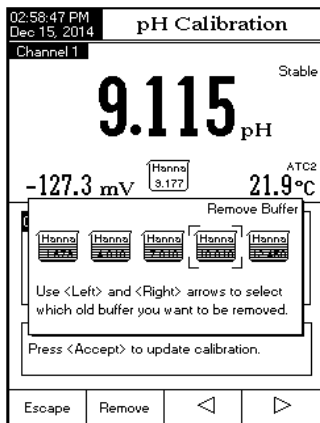

CALIBRATION MESSAGES

- **Move sensor to next buffer or check buffer:** this message appears when the difference between the pH reading and the value of the selected calibration buffer is significant. If this message is displayed, check if you have selected the appropriate calibration buffer.
- **Wrong buffer temperature:** this message appears if the buffer temperature is out of the defined buffer temperature range.
- **Clean the electrode or check the buffer. Press to update calibration:** this message alerts the user that some dirt or deposits could be on the electrode. Refer to the electrode Cleaning Procedure.
- **Slope too low. Please check the buffer / Slope too high. Please check the buffer:** these messages appear if the current slope is under 80 % or over 110 % of default slope. Recalibrate the instrument using fresh buffers.
- **Slope too low. Press to clear old calibration / Slope too high. Press to clear old calibration:** verify the correct buffer has been selected and poured.
- **Unrecognized buffer. Please check the buffer or the buffer list** (for Semiautomatic and Automatic buffer entry type): this message appears if the current buffer value is not close to any of the buffers from the buffer list/group. Check if the current buffer is present in the buffer list or the appropriate buffer group was selected.
- **The current buffer was already calibrated:** change the buffer or press to exit calibration mode.

Verify the pH electrode and instrument has been calibrated before making pH measurements.

DIRECT MEASUREMENT

To measure the pH of a sample using the Direct reading mode:

- Press **MODE** and then **pH** to select **pH Measure** mode.
- Select the Direct reading mode (see pH Setup for details).
- Place the electrode tip and the temperature probe approximately 4 cm (1½”) into the sample to be tested. Allow time for the electrode to stabilize.
- The measured pH value will be displayed on the LCD, together with a short GLP information and display preferences.

Note: If the reading is out of range, “—” will be displayed on the LCD.

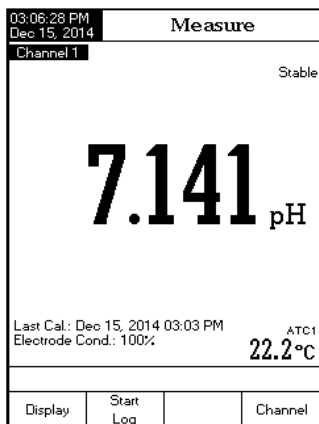

DIRECT/AUTOHOLD MEASUREMENT

To measure pH of a sample using the Direct/AutoHold reading mode:

- Press **MODE** and then **pH** to select **pH Measure** mode.
- Select the Direct/AutoHold reading mode (see pH Setup for details).
- Place the electrode tip and the temperature probe approximately 4 cm (1½”) into the sample to be tested.
- The measured pH value will be displayed on the LCD. Press **Auto Hold** and the “AutoHold” indicator will start

blinking on the LCD until the stability criterion is reached. The pH value will be frozen on the LCD, along with “AutoHold” indicator.

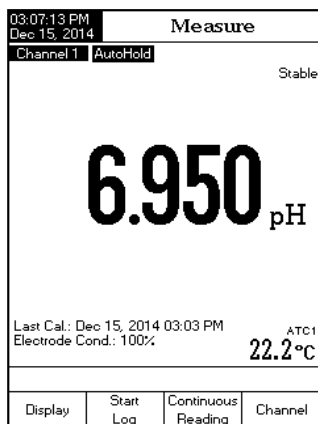

- To return to normal **Measure** mode press 

Note: If the reading is out of range, “—” will be displayed on the LCD.

Outside Cal Range warns the user if the current reading is out of the calibrated area. The calibrated area is that part of the pH range in which the calibration point assures an accurate reading. If the reading is taken out of the calibration area, the “Outside Cal Range” message will start blinking on the LCD. The calibrated area is calculated in accordance with the pH resolution used during the measurement. To avoid triggering this message, the buffer values have to be well distributed in the desired measurement range.



If measurements are taken successively in different samples, it is recommended to rinse the electrode thoroughly with deionized water or tap water and then with some of the next sample before immersing it into the next sample solution.





The pH reading is affected by temperature. In order to measure the pH accurately, the temperature effect must be compensated. To use the **Automatic Temperature Compensation (ATC)** feature, connect and place the HI7662-W temperature probe into the sample as close as possible to the electrode and wait for a few seconds.

If the temperature of the sample is known, **Manual Temperature Compensation (MTC)** can be used by disconnecting the temperature probe.

Notes: For mV/Rel mV measurements “NoProbe1”/“NoProbe2” or “TEMP1”/“TEMP2” will be displayed.

For the other measurements “MTC1”/“MTC2” or “ATC1”/“ATC2” indicators will be displayed.

When in MTC mode, the temperature can be modified by pressing  for mV /Rel mV Measure mode and  for other Measure mode, if the Reading Mode option is Direct.

The temperature value can be adjusted with  or  from -20.0 °C to 120.0 °C. Press  to save the new temperature value or press  to return to Measure mode without changing the MTC value.

When in ATC mode “—” will be displayed on the LCD if the ATC signal is under or over the temperature range (-20.0 °C to 120.0 °C).

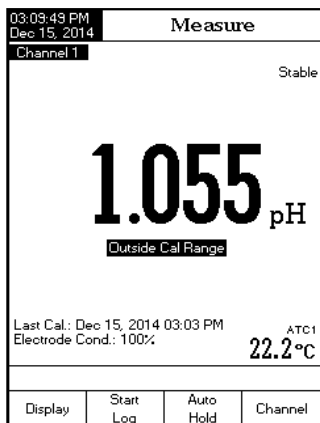

mV/ORP MEASUREMENTS

Oxidation-reduction potential (ORP) measurements provide the quantification of the oxidizing or reducing power of the tested sample.

To correctly perform a redox measurement, the surface of the ORP electrode must be clean and smooth.

DIRECT MEASUREMENT

To measure the mV of a sample using the Direct reading mode:

- Press **MODE** and then **mV** to enter **mV Measure** mode.
- Select the Direct reading mode (see mV Setup for details).
- Place the tip of the ORP electrode 4 cm (1½") into the sample to be tested and allow a few seconds for the reading to stabilize.
- The instrument will display the measured mV value on the LCD.

Note: If the reading is out of range, “—” may be displayed on the LCD.



DIRECT/AUTOHOLD MEASUREMENT

To measure mV of a sample using the Direct/AutoHold reading mode:

- Press **MODE** and then **mV** to select **mV Measure** mode.
- Select the Direct/AutoHold reading mode (see mV Setup for details).
- Place the tip of the ORP electrode approximately 4 cm (1½") into the sample to be tested.
- The measured mV value will be displayed on the LCD. Press **Auto Hold** and the “AutoHold” indicator will start blinking on the LCD until the stability criterion is reached. The mV value will be frozen on the LCD, along with “AutoHold” indicator.
- To return to normal *Measure* mode press **Continuous Reading**.

Note: If the reading is out of range, “—” may be displayed on the LCD.

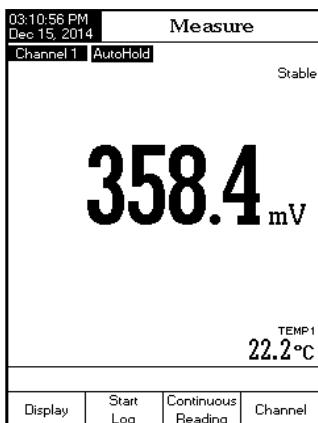

Relative mV MEASUREMENTS

To measure the **Relative mV** of a sample:

- Press **MODE** then **Rel mV** (select Channel 1).
- Verify if a current calibration has been made.
- If required, conduct the single point Rel mV calibration. Verify the tip of the electrode is immersed into the known solution or ORP standard.
- Press **CAL**. Use **Δ** and **∇** keys to set the standard value. Press **Accept** to store the calibration.
- Press **MODE** then **Rel mV** (select Channel 1).
- Place calibrated sensor tip into the sample to be analyzed. The instrument will display the measured Relative mV value on the LCD, together with a short GLP information about the last calibration or Offset: 0.0 mV no Rel mV calibration was performed.

Notes: If the ORP sensor is not in solution or the measured mV potential is out of range, “—” may be displayed on the LCD.

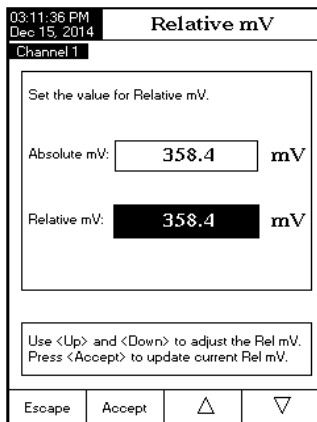

For greater accuracy, it is recommended to calibrate the ISE sensors frequently. The instrument should be recalibrated when "ISE x Calibration Expired" (the "x" represents channel "1" or channel "2") message appears on the LCD, in the Reminder messages area.

Due to electrode conditioning time, the electrode must be kept immersed a few seconds to stabilize. The user will be guided step by step during calibration with easy-to-follow messages on the display. This will make the calibration a simple and error-free procedure.

PREPARATION

Pour small quantities of the standard solutions into clean beakers. If possible, use plastic beakers to minimize any EMC interferences.

For accurate calibration and to minimize cross-contamination, use two beakers for each standard solution. One for rinsing the electrode and one for calibration.

Note: To read concentration (not activity) ISA must be added to the standards and samples. No corrections are needed for dilutions.

CALIBRATION PROCEDURE

The ISE calibration and measurement can be performed with or without temperature compensation. If temperature compensation option is enabled, the isopotential point of the electrode must be set in ISE Setup in order to calculate the correct concentration measurement.

Before calibrating, make sure that the appropriate Electrode Type has been selected in ISE Setup according to the measured ion/compound.

ISE Calibration screen description

The screenshot shows the ISE Calibration screen with the following elements and annotations:

- Top Bar:** Time: 03:26:38 PM, Date: Dec 15, 2014, Title: ISE Calibration.
- Channel 1:** Channel identifier.
- Measured concentration:** 10100 mg/L (with "Stable" indicator).
- Calibration Standard:** 371.2 mV (with "10000" multiplier) and 22.3°C (with "ATC1" indicator).
- Calibrated Standards:** A row of four boxes containing values: E-2 1.00, 10.0, 100, 1000.
- Calibration messages:** A text box containing "Press <Accept> to update calibration."
- Bottom Bar:** Navigation buttons: Escape, Accept, Next Standard, Previous Standard.

The groups of calibration standards is set under ISE Setup > Calibration. Select standards that are in the measurement range of the samples.

To calibrate the instrument:

- Press **[CAL]**. If the instrument was calibrated before and calibration was not cleared, the old calibration can be cleared by pressing **[Clear Cal]**. After 10 seconds, **[Clear Cal]** will no longer be available.

Note: It is very important to clear calibration history when a new electrode is used because most errors and warning messages that appear during calibration depend on calibration history.

- Add ISA to both standard solutions and samples.
- Immerse the Ion Selective Electrode and the temperature probe approximately 2 cm (1") into the less concentrated standard solution and stir gently.
- Select the appropriate standard solution concentration with **[Next Standard]** or **[Previous Standard]**. For All Standards manual entry mode, the standard concentration can be selected from a list containing all the predefined and custom standards. For Group Standard manual entry mode the standard concentration can be selected from the predefined group of standards. Press **[Accept]** to calibrate the electrode in the standard.

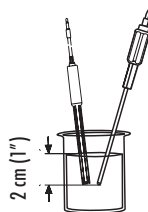

*Note: To adjust standard value: Press **[SETUP]**. A pop-up menu will be displayed on the LCD in which the concentration value can be adjusted using **[Δ]** or **[▽]**. Press **[Accept]** to save the new concentration value.*

- The "Please wait..." message will appear on the LCD for 10 seconds. Remove ISE from first standard, rinse tip and immerse the ion selective electrode and the temperature probe into the next standard solution and follow the above procedure or press **[Escape]** to exit calibration.

Notes: The new added calibration point will replace an old one if the difference between them is less than 20 % of the standard solution.

*If the existing stored calibration is full (five calibration points), a pop-up menu will be displayed on the LCD in which you can select with **[<]** or **[>]** the standard solution you want to replace with the current one.*

*Press **[Remove]** to delete the selected calibrated point and then press **[Accept]** to update calibration with the new standard solution.*

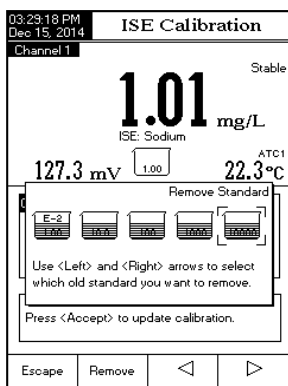

- If the isopotential point of the electrode is unknown, the ISE calibration and measurements can be performed without temperature compensation (see ISE Setup, Temperature option for details).
- When in MTC mode, after selecting a standard press **SETUP**, a pop-up menu will be displayed on the LCD in which the concentration and the temperature value can be adjusted by pressing **Edit** and then **Δ** or **∇** keys. Press **Accept** to save the modified value and then **Next** / **Previous** to select next/previous value to be adjusted. MTC value will have no effect on measurement but will be included on log data.

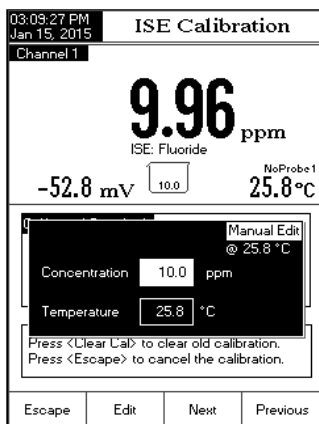

CALIBRATION MESSAGES

- **Wrong standard solution. Check the standard solution.** This message appears when the difference between the reading and the value of the selected standard solution concentration is significant. If this message is displayed, check if you have selected the appropriate calibration standard.
- **The current standard was already calibrated or standards too close.** This message appears when the difference between current ISE standard and the already calibrated standard is too low.
- **Slope too low. Check the standard solution. / Slope too high. Check the standard solution.** Recalibrate using fresh standards.
- **Difference between standards temperature is too high. Press <Accept> to update the calibration or clear old calibration.** Please ensure that the temperature difference between the standards used in calibration is not greater than 5.0 °C.
- **Standard too close. Change the standard or clear calibration.** The current calibration standard is too close to an already calibrated standard. Please change the standard or clear old calibration.
- **Press <Clear Cal> to clear old calibration.** Clear the old calibration points.

Make sure the instrument and ISE sensor have been calibrated before making ISE measurements. When using one of the incremental methods for measurement, at least a two-point ISE calibration must be performed to establish the electrode slope.

For accurate measurements, add the appropriate ISA (Ionic Strength Adjuster) to both samples and standards. Consult ISE manual for sensor preparation details.

DIRECT MEASUREMENT

To measure the concentration of a sample using the Direct reading mode:

- Press **MODE** and then **ISE** to select **ISE Measure** mode for the selected channel.
- Select the Direct reading mode (see ISE Setup for details).
- Add ISA to the sample solution.
- Submerge the Ion Selective Electrode tip and the temperature probe approximately 2 cm (1") into the sample. Allow time for the electrode to stabilize.
- The measured concentration value will be displayed on the LCD in the selected units.

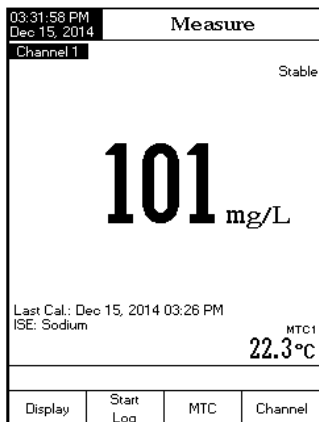

Note: If the reading is out of range, “—” may be displayed on the LCD.

DIRECT/AUTOHOLD MEASUREMENT

To measure the concentration of a sample using the Direct/AutoHold reading mode:

- Press **MODE** and then **ISE** to select **ISE Measure** mode for the selected channel.
- Select the Direct/AutoHold reading mode (see ISE Setup for details).
- Add ISA to the sample solution.
- Dip the Ion Selective Electrode tip and the temperature probe approximately 2 cm (1") into the sample to be tested.
- The measured concentration value will be displayed on the LCD. Press **Auto Hold**, the “AutoHold” indicator will blink on the LCD until the stability criterion is reached. The concentration value will be frozen on the LCD, along with “AutoHold” indicator.

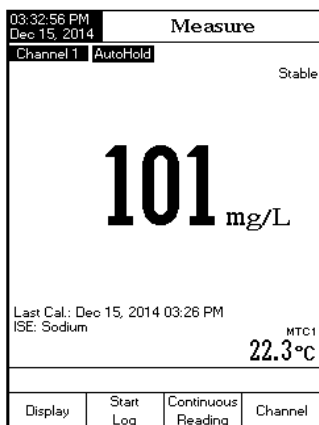

- To return to normal Measure mode press Continuous Reading.

Note: If the reading is out of range, “—” may be displayed on the LCD.

KNOWN ADDITION

To measure the concentration of a sample using the Known Addition incremental method:

- Press MODE and then ISE to select ISE Measure mode for the selected channel.
- Select the Known Addition method (see ISE Setup for details).
- Prior to starting a KA procedure, the ISE sensor must be calibrated with a minimum of two standards containing ISA. The slope of the electrode will be used in all calculations involved in KA.
- If following an established procedure: Press KA, edit the method variables and follow the procedure below.
- Press Edit to set the method parameters. Press Next / Previous to select next/previous parameter to edit, then press Edit and use Δ or ▽ to set the desired parameter value. Press Accept to save the modified value and then press Escape to exit method parameters edit menu.
- If developing a procedure: Before attempting Known Addition analysis it is important to determine what sample volume, standard concentration and standard volume will produce the best results. As a general rule, the addition of standard should change the mV value of the sample by 15 - 20 mV. For a positively charged ion (i.e. Sodium, Potassium, Calcium), the standard addition should increase the mV. For a negatively charged ion (i.e. Sulfide, Fluoride, Chloride), the standard addition should decrease the mV. Start with a small trial. For example: Measure 50 mL of sample, add a magnetic stir bar, place on a stirrer, add ISA (consult ISE manual) and place ISE electrode tip into the sample. Put instrument in mV mode and record the observed mV. Using a micropipette, add a volume of the highest ISE standard available (i.e. 0.1M or 1000 ppm). Start by adding 500 μ L at a time (for example). Watch the change in mV. When you have observed approximately a 15 mV change from the original sample. Calculate the total volume added. Adjust sample and standard volumes proportionally to standard volumes that can be measured with accuracy. Use volumetric pipettes for standard, ISA and sample addition.

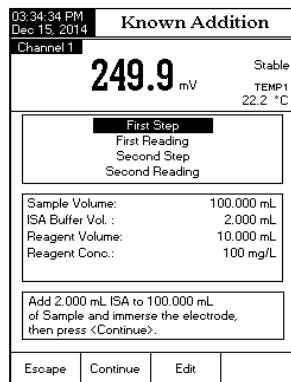
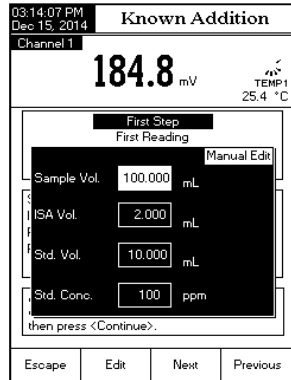

- Press **KA**: Edit the procedure variables to the volumes determined in the prior step.
- Procedure:
- Press **KA** to enter Known Addition mode.
 - Volumetrically add sample to a clean beaker. Add magnetic stir bar and place on a stir plate. Stir sample. The method will prompt user to add ISA. Place ISE sensor tip into the solution and a mV value will show on the display.
 - Press **Continue** to take the first mV reading.
 - When the reading is stable, press **Read** to store the first mV reading. The second step of the method will be displayed on the LCD in which the user is notified to add the volume of standard to the sample.
 - Press **Continue** to take the second mV reading.
 - When the reading is stable, press **Read** to store the second mV reading. The ISE measurement results will be displayed on the LCD.
 - Press **Save** to log the current results into a ISE Method Report. Press **Direct Measure** to return to ISE Measure mode. Press **Start KA** to measure additional samples. Rinse ISE sample between samples.
 - Press **Edit**, to modify the method parameters.
- Note: Press **Escape** at any time to stop the measurement and return to ISE Measure mode.*

03:35:26 PM Dec 15, 2014		ISE Results	
Channel 1		102 mg/L	
Sample ID: Calculated Slope: 104.1 % Reading 1: 249.9 mV Reading 2: 249.9 mV Sample Volume: 100.000 mL Reagent Volume: 10.000 mL ISA Volume: 2.000 mL Reagent Conc.: 100 mg/L			
Press <Direct Measure> to return in main measurement panel. Press <Save> to log the current results.			
Direct Measure	Save	Edit	Start KA

KNOWN SUBTRACTION

To measure the concentration of a sample using the Known Subtraction method:

- Press **MODE** and then **ISE** to select ISE Measure mode for the selected channel.
- Select the Known Subtraction method (see ISE Setup > Reading Mode).
- Prior to starting a KS procedure, the ISE sensor must be calibrated with a minimum of two standards containing ISA. The slope of the electrode will be used in all calculations involved in KS.
- If following an established procedure: Press **KS** then edit the method variables and follow the procedure below.
- Press **Edit** to set the method parameters. Press **Next** / **Previous** to select next/previous parameter to edit, then press **Edit** and use **Δ** or **∇** to set the desired parameter value. Press **Accept** to save the modified value and then press **Escape** to exit method parameters edit menu.
- If developing a procedure: Before attempting Known Subtraction analysis it is important to determine what sample volume, standard reactant concentration and standard volume will

produce the best results and the way the reagent will react with the measured ion on a molar basis (stoichiometric factor). As a general rule, the addition of standard should change the mV value of the sample by 15-20 mV. For a positively charged ion (i.e. Calcium), the reactant addition should decrease the mV. For a negatively charged ion (i.e. Sulfide, Fluoride, Chloride), the reactant addition should increase the mV. Start with a small trial. For example: Measure 50 mL of sample, add a magnetic stir bar, place on a stirrer, add ISA (consult ISE manual) and place ISE electrode tip into the sample. Put instrument in mV mode and record the observed mV. Using a micropipette, add a volume of the reactant standard. Start by adding 500 μL at a time (for example). Watch the change in mV. When you have observed approximately a 15 mV change from the original sample, calculate the total volume added. Adjust sample and standard volumes proportionally to standard volumes that can be measured with accuracy. Use volumetric pipettes for standard, ISA and reagent addition.

- Press **KS** then edit the procedure variables to the volumes determined in the prior step.

Procedure:

- Press **KS** to enter Known Subtraction mode.
- Volumetrically add sample to a clean beaker. Add magnetic stir bar and place on a stir plate. Stir sample. The method will prompt user to add ISA. Place ISE sensor tip into the solution and a mV value will show on the display.
- Press **Continue** to take the first mV reading.
- When the reading is stable, press **Read** to store the first mV reading. The second step of the method will be displayed on the LCD in which the user is notified to add the volume of reagent to the sample.
- Press **Continue** to take the second mV reading.
- When the reading is stable, press **Read** to store the second mV reading. The ISE measurement results will be displayed on the LCD.
- Press **Save** to log the current results into an ISE Method Report. Press **Direct Measure** to return to ISE Measure mode. Press **Start KS** to start another measurement. Rinse ISE sensor between samples.
- Press **Edit** to modify parameters.

*Note: Press **Escape** at any time to stop the measurement and return to ISE Measure mode.*

ANALYTE ADDITION

To measure the concentration of a sample using Analyte Addition method:

- Press **MODE** and then **ISE** to select ISE Measure mode.
- Select the Analyte Addition method (see ISE Setup > Reading mode).

- Prior to starting an AA procedure, the ISE sensor must be calibrated with a minimum of two standards containing ISA. The slope of the electrode will be used in all calculations involved in AA.
- If following an established procedure: Press then edit the method variables and follow the procedure below.
- Press to set the method parameters. Press / to select next/previous parameter to edit, then press and use or to set the desired parameter value. Press to save the modified value and then press to exit method parameters edit menu.
- If developing a procedure: Before attempting Analyte Addition analysis, it is important to determine which standard volume, concentration and sample size will produce the best results. As a general rule, the standard must be less concentrated than the sample so the addition of sample will increase the total ion content of the beaker and change the mV value by at least 10 mV. For a positively charged ion (i.e. Sodium), the AA increases the mV. For a negatively charged ion (i.e. Sulfide, Fluoride, Chloride), the AA should decrease the mV. Start with a small trial. For example: Measure 50 mL of standard, add a magnetic stir bar and place on a stirrer, add ISA (consult ISE manual) and place ISE electrode tip into the sample. Put instrument in mV mode and record the observed mV. Using a micropipette, add a volume of the sample. Start by adding 500 μ L at a time (for example). Watch the change in mV. When you have observed approximately a 10 mV change from the original standard, calculate the total volume added. Adjust sample and standard volumes proportionally to standard volumes that can be measured with accuracy. Use volumetric pipettes for standard, ISA and sample addition.
- Press then edit the procedure variables to the volumes determined in the prior step.

Procedure:

- Press to enter Analyte Addition mode.
- Volumetrically add standard to a clean beaker. Add magnetic stir bar and place on a stir plate. Stir standard. The method will prompt user to add ISA. Place ISE sensor tip into the solution and a mV value will show on the display.
- Press to take the first mV reading.
- When the reading is stable, press to store the first mV reading. The second step of the method will be displayed on the LCD, in which the user is notified to add the sample volume to the standard solution. The method parameters are also displayed on the LCD.
- Press to take the second mV reading.
- When the reading is stable, press to store the second mV reading. The ISE measurement results will be displayed on the LCD.
- Press to log the current results into an ISE Method Report. Press to return to ISE Measure mode.

- Press **Start** to start another measurement. Rinse ISE sensor between samples.
- Press **Edit** to modify the method parameters.

*Note: Press **Escape** at any time to stop the measurement and return to ISE Measure mode.*

ANALYTE SUBTRACTION

To measure the concentration of a sample using Analyte Subtraction method:

- Press **MODE** and then **ISE** to select ISE Measure mode for the selected channel.
- Select the Analyte Subtraction method (see ISE Setup > Reading Mode).
- Prior to starting an AS procedure, the ISE sensor must be calibrated with a minimum of two standards containing ISA. The slope of the electrode will be used in all calculations involved in AS.
- If following an established procedure: Press **AS** then edit the method variables and follow the procedure below.
- Press **Edit** to set the method parameters. Press **Next** / **Previous** to select next/previous parameter to edit, then press **Edit** and use **Δ** or **∇** to set the desired parameter value. Press **Accept** to save the modified value and then press **Escape** to exit method parameters edit menu.
- If developing a procedure: Before attempting Analyte Subtraction analysis, it is important to determine which sample volume, reactant volume and concentration, will produce the best results and the way the reagent will react with the measured ion on a molar basis (stoichiometric factor). As a general rule, the reactant should contain the measured Ion so the sample addition will react with the Ion and reduce the measured concentration of the sample. The change of the mV value, before and after the sample addition, should be at least 10 mV. Start with a small trial. For example: Measure 50 mL of reactant, add a magnetic stir bar and place on a stirrer, add ISA (consult ISE manual) and place ISE electrode tip into the sample. Put instrument in mV mode and record the observed mV. Using a micropipette, add a volume of the sample. Start by adding 500 μL at a time (for example). Watch the change in mV. When you have observed approximately a 10 mV change from the original value, calculate the total volume added. Adjust sample and standard volumes proportionally to standard volumes that can be measured with accuracy. Use volumetric pipettes for standard, ISA and sample addition.
- Press **AS** then edit the procedure variables to the volumes determined in the prior step.

Procedure:

- Press **AS** to enter Analyte Subtraction mode.
- Volumetrically add Reactant to a clean beaker. Add magnetic stir bar and place on a stir plate. Stir standard. The method will prompt user to add ISA. Place ISE sensor tip into the solution and a mV value will show on the display.

- Press **Continue** to take the first mV reading.
- When the reading is stable, press **Read** to store the first mV reading. The second step of the method will be displayed on the LCD in which the user is notified to add the Sample Volume to the standard solution.
- Press **Continue** to take the second mV reading.

The **Conductivity Setup** menu allows the user to set the parameters related to the conductivity measurement and calibration. These parameters can be set specifically for Channel 2 only.

Accessing Conductivity Setup

- Press **MODE** while in **Measure** mode and then **Cond.** to select the **Conductivity** measurement mode.
- Press **SETUP** and then **Cond. Setup...** to access **Conductivity Setup** menu.

To access a **Conductivity Setup** option:

- Use **Δ** or **∇** to highlight the desired option.
- Press **Select** to access the selected option or **Escape** to exit setup.

The following is a detailed description of the **Conductivity Setup** option screens.

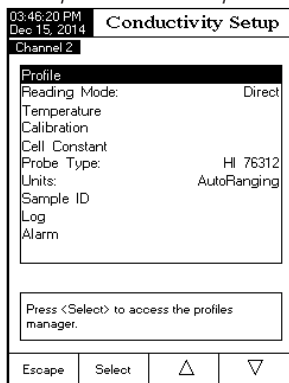

Profile

This option opens the **Profile** manager. Enabling **Profile** allows the user to Save, Load or Delete an application **Profile**. The **Profile** option allows the user to store up to ten separate profile applications (five profiles for each channel). Each **Profile** can be named and recalled at a moment's notice. A profile is a sensor setup complete with measurement units, logging and display preferences, calibration standards (Standards including custom), setup of the Display screen for measurement (i.e. single, dual, graphing, GLP) and any other sensor configuration. Once saved, the exact same profile can be used at another time. This is a handy feature if the meter is used occasionally for additional applications because it saves time in the setup of the meter and ensures the same procedure will be used.

To save the measurement configuration for **Conductivity** mode:

- Press **SETUP**, then **Cond. Setup** and use **Δ** or **∇** to highlight Profile option.
- Press **Enable** / **Disable** to enable / disable this feature.

The available options are:

Profile Feature: enable or disable the profile feature.

Save Profile: save the current profile.

Save Profile As...: save current profile using a specific name.

Load Profile: load from available profiles.

Delete Profile: delete a profile.

Save Profile

To save a profile:

- Press **SETUP** while in **Conductivity** mode.
- Press **Cond. Setup**.
- Use **Δ** or **∇** to highlight **Profile** option.
- Press **Select** and then use **Δ** or **∇** to highlight **Save Profile**.
- Press **Select**. The existing configuration will be saved in current profile.

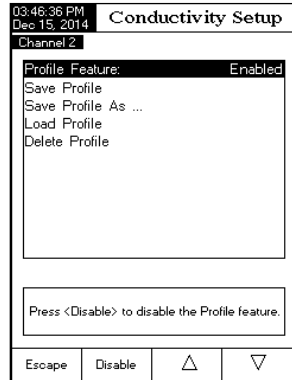

Save Profile As...

To create a new profile:

- Press **SETUP** while in **Conductivity** mode.
- Press **Cond. Setup**.
- Use **Δ** or **∇** to highlight **Profile** option.
- Press **Select** and then use **Δ** or **∇** to highlight **Save Profile As...**
- Press **Select**. The Text Editor box will be displayed on the LCD.
- Enter the desired profile name by using **▶** and **∇** to highlight the desired character and then press **Select** to add it to the text bar. It is also possible to delete the last character by positioning the cursor on the Backspace character (ⓧ) and pressing **Select**.
- Press **Escape** to return to the previous menu. If the Saving Confirmation is enabled, press **Yes** to accept the modified option, **No** to escape without saving or **Cancel** to return to the editing mode. Otherwise, the modified option is saved automatically.

Note: The saved profile will automatically become the current profile.

Load Profile

To load one profile:

- Press **SETUP** while in **Conductivity** mode.
- Press **Cond. Setup**.
- Use **Δ** or **∇** to highlight the **Profile** option.
- Press **Select** and then use **Δ** or **∇** to highlight the **Load Profile** option.

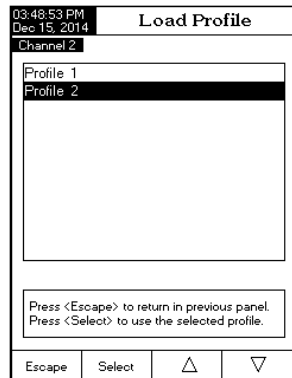

- Press **Select**. A list with all customized profiles will be displayed on the screen.
- Use **Δ** or **∇** to select the desired profile and press **Select** to confirm or **Escape** to exit without selecting.

Delete Profile

To delete one of the existing profiles:

- Press **SETUP** while in **Conductivity** mode.
- Press **Cond. Setup**.
- Use **Δ** or **∇** to highlight the **Profile** option.
- Press **Select** and then use **Δ** or **∇** to highlight the **Delete Profile** option.
- Press **Select**. A list with all customised profiles will appear on the screen.
- Use **Δ** or **∇** to select the desired profile and press **Delete**.
- Press **Escape** to return to the previous menu.

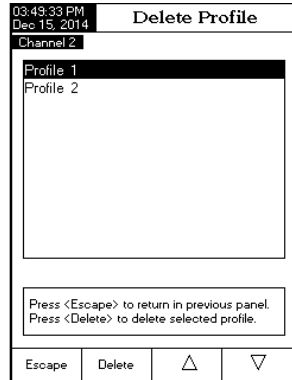

Reading Mode

This option allows the user to select between Direct, Direct/AutoHold or Direct/USP conductivity reading modes.

*Note: All three selections permit conductivity to be changed to resistivity, TDS and salinity via the **MODE** key.*

To set the reading mode:

- Press **SETUP** while in **Conductivity** mode.
- Press **Cond. Setup**.
- Use **Δ** or **∇** to highlight the **Reading Mode** option.
- Press **Select** and then use **Δ** or **∇** to highlight the desired option.
- Press **Select** to confirm your selection or press **Escape** to cancel operation.

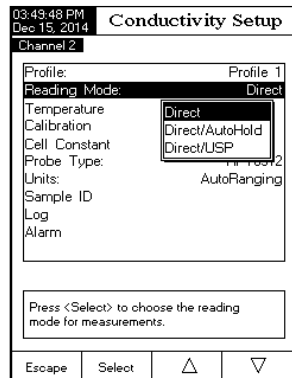

Temperature

From the Temperature menu the user can choose the Temperature Source and Units, as well as the Temperature Compensation mode, Reference Temperature and Compensation Coefficient.

Temperature Source

To set the **temperature source**:

Note: The HI76312 sensor has an integral temperature sensor and will provide the best conductivity measurement. Channel 2 should be selected to utilize the integrated temperature sensor.

- Press **SETUP** while in **Conductivity** mode.
- Press **Cond. Setup**.
- Use **△** or **▽** to highlight the **Temperature** option.
- Press **Select** and then use **△** or **▽** to highlight the **Temperature Source** option.
- Press **Select** and then use **△** or **▽** to select Manual, Channel 1 or Channel 2 temperature source.
- Press **Select** to confirm your selection or press **Escape** to cancel operation.

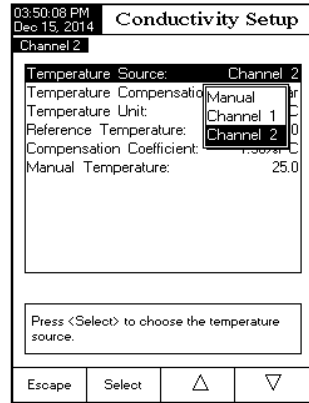

Temperature Compensation

The user can choose from the following options:

Linear - the meter will automatically compensate the conductivity using the following formula:

$$C_{ref} = \frac{C_I}{1 + \frac{\alpha}{100}(T_I - T_{ref})}$$

where:

- C_{ref} - conductivity at reference temperature
- C_I - conductivity at temperature of measurement
- α - compensation coefficient
- T_I - temperature in °C
- T_{ref} - reference temperature

Non-Linear - recommended for measuring the conductivity of the natural water in accordance with the ISO-788-1985. It provides compensation in the range of 60 to 1000 $\mu\text{S}/\text{cm}$ over a temperature range of 0 - 35 °C.

Disabled - the meter will display the Absolute conductivity with no temperature compensation.

To set the **temperature compensation mode**:

- Press **SETUP** while in **Conductivity** mode.
- Press **Cond. Setup**.
- Use **Δ** or **∇** to highlight the **Temperature** option.
- Press **Select** and then use **Δ** or **∇** to highlight the **Temperature Compensation** option.
- Press **Select** and then use **Δ** or **∇** to select **Linear**, **Non-Linear** or **Disabled** option.
- Press **Select** to confirm your selection or press **Escape** to cancel operation.

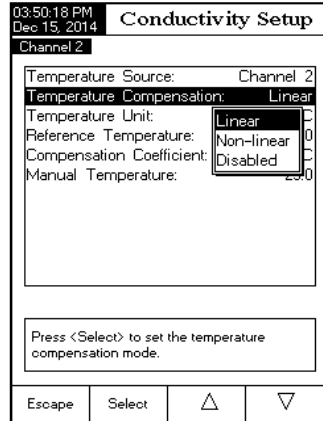

Note: Whatever form of compensation is used, the reading will not be as accurate as taking a reading of the sample's conductivity at the reference temperature.

Temperature Unit

The user can choose from the Celsius, Fahrenheit or Kelvin temperature units.

To set the **temperature unit**:

- Press **SETUP** while in **Conductivity** mode.
- Press **Cond. Setup**.
- Use **Δ** or **∇** to highlight the **Temperature** option.
- Press **Select** and then use **Δ** or **∇** to highlight the **Temperature Unit** option.
- Press **Select** and then use **Δ** or **∇** to select **Celsius**, **Fahrenheit** or **Kelvin** unit.
- Press **Select** to confirm your selection or press **Escape** to cancel operation.

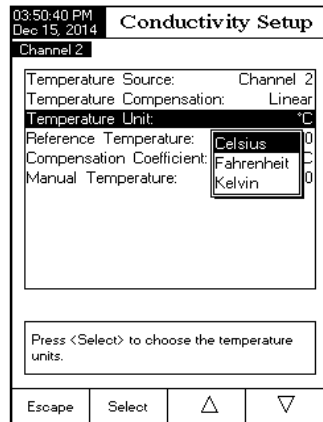

Reference Temperature (Linear or Non-Linear temperature compensation only)

Note: ISO-7888-1985 requires a reference temperature of 25 °C.

To set the **reference temperature**:

- Press **SETUP** while in **Conductivity** mode.
- Press **Cond. Setup**.
- Use **Δ** or **∇** to highlight the **Temperature** option.
- Press **Select** and then use **Δ** or **∇** to highlight the **Reference Temperature** option.
- Press **Select** and then use **Δ** or **∇** to increase / decrease the value.
- Press **Accept** to save or press **Escape** to cancel operation.

03:50:54 PM Dec 15, 2014	Reference Temp.		
Channel 2			
Edit reference temperature:			
25.0		°C	
Limit Low:	5.0 °C		
Limit High:	30.0 °C		
Use <Up> and <Down> arrows to set value.			
Press <Accept> to save the current value. Press <Escape> to exit to previous screen.			
Escape	Accept	Δ	∇

Compensation Coefficient (Linear temperature compensation only)

The temperature coefficient is a factor used to express the rate a solution's conductivity increases with an increase in temperature and is expressed as a % increase in conductivity, for a temperature change of 1 °C. The coefficient differs for different binary solutions. For typical aqueous dilute salt mixtures, 1.90 %/°C is used. Ultrapure water is 5.50 %/°C.

To set the **compensation coefficient**:

- Press **SETUP** while in **Conductivity** mode.
- Press **Cond. Setup**.
- Use **Δ** or **∇** to highlight the **Temperature** option.
- Press **Select** and then use **Δ** or **∇** to highlight the **Compensation Coefficient** option.
- Press **Select** and set the desired compensation coefficient using **Δ** or **∇** to increase/decrease the value.
- Press **Accept** to save the current value or press **Escape** to cancel operation.

03:51:10 PM Dec 15, 2014	Temp. Coefficient		
Channel 2			
Edit Temperature Compensation Coeff.:			
1.90		%/°C	
Limit Low:	0.00 %/°C		
Limit High:	10.00 %/°C		
Use <Up> and <Down> arrows to set value.			
Press <Accept> to save the current value. Press <Escape> to exit to previous screen.			
Escape	Accept	Δ	∇

Calibration

Using standard solutions:

The probe and meter can be calibrated with a single standard or with multiple standards (up to four points), choosing from six Hanna standards (84 $\mu\text{S}/\text{cm}$, 1413 $\mu\text{S}/\text{cm}$, 5.0 mS/cm , 12.88 mS/cm , 80.0 mS/cm , 111.8 mS/cm) or using the custom standards. Multiple point calibrations are used to increase accuracy when measurements are made over an extended range. Choose standards that are in the sample measurement range of interest. Use only one standard for each measurement range.

Measurement Range	Calibration Standards
0 - 200 $\mu\text{S}/\text{cm}$	84.00 $\mu\text{S}/\text{cm}$
200 - 2000 $\mu\text{S}/\text{cm}$	1413 $\mu\text{S}/\text{cm}$
2 - 20 mS/cm	5.000 or 12.88 mS/cm
20 - 1000 mS/cm	80.0 or 111.8 mS/cm

The following options are available for calibration:

Standard Recognition

The user can choose between Automatic recognition (from six Hanna standards available) or User Standard (when custom standards are used for calibration).

To set the **standard recognition**:

- Press **SETUP** while in **Conductivity** mode.
- Press **Cond. Setup**.
- Use **Δ** or **▽** to highlight the **Calibration** option.
- Press **Select** and then use **Δ** or **▽** to highlight the **Standard Recognition** option.
- Press **Automatic** to choose **Automatic** recognition mode.
- Press **User Standard** to choose **User Standard** mode.

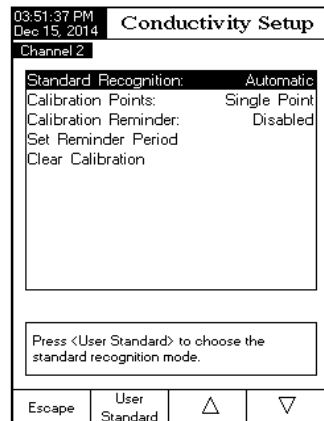

Calibration Points

The user can choose between Single Point or Multi Points calibration.

To set the calibration points:

- Press **SETUP** while in **Conductivity** mode.
- Press **Cond. Setup**
- Use **Δ** or **▽** to highlight the **Calibration** option.
- Press **Select** and then use **Δ** or **▽** to highlight the **Calibration Points** option.
- Press **MultiPoints** to choose **Multiple Points** calibration.
- Press **SinglePoint** to choose **Single Point** calibration.

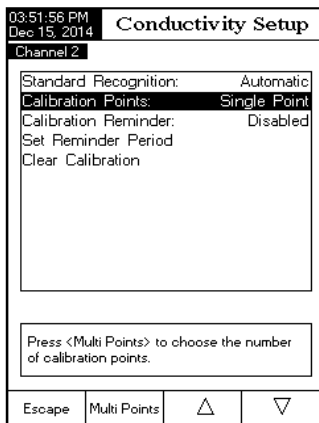

Calibration Reminder

This option allows the user to set the calibration reminder as Daily, Periodic or Disabled.

To set the calibration reminder:

- Press **SETUP** while in **Conductivity** mode.
- Press **Cond. Setup**
- Use **Δ** or **▽** to highlight the **Calibration** option.
- Press **Select** and then use **Δ** or **▽** to highlight the **Calibration reminder** option.
- Press **Select** to confirm your selection and then use **Δ** or **▽** to choose the desired option.
- Press **Select** to confirm your selection or press **Escape** to cancel operation.

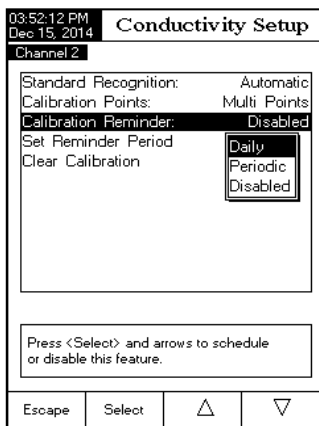

Set Reminder Period

Daily reminder - the user can set the time of day when the reminder is to appear.

Periodic reminder - the user can set the time from the last calibration (days, hours and minutes) after which the reminder appears.

To set the **reminder period**:

- Press **SETUP** while in **Conductivity** mode.
- Press **Cond. Setup**
- Use **Δ** or **▽** to highlight the **Calibration** option.

- Press **Select** and then use **Δ** or **∇** to highlight the **Set Reminder Period** option.
- Press **Select** and use **Next** / **Previous** to select next / previous entry to be edited.
- Press **Edit** and use **Δ** or **∇** to set the desired value, then press **Accept** to save the modified value or press **Escape** to cancel operation.
- Press **Escape** to return to the previous menu.

Clear Calibration

Accessing this option, the existent conductivity calibration can be cleared. If the calibration is cleared, another calibration has to be performed.

To clear calibration:

- Press **SETUP** while in **Conductivity** mode.
- Press **Cond. Setup**
- Use **Δ** or **∇** to highlight the **Calibration** option.
- Press **Select** and then use **Δ** or **∇** to highlight the **Clear Calibration** option.
- Press **Select** to clear calibration. A pop-up menu will be displayed asking for confirmation (if calibration is available).
- Press **Yes** to confirm or press **No** to escape without saving and return to the Calibration options.

Cell Constant







The conductivity probe can be calibrated using conductivity standards and the calibration function or by entering the cell constant of the probe.

To edit the **cell constant** value:

- Press **SETUP** while in **Conductivity** mode.
- Press **Cond. Setup**
- Use **Δ** or **∇** to highlight the **Calibration** option.
- Press **Select** and then use **Δ** or **∇** to highlight the **Cell Constant** option.

03:18:52 PM Dec 15, 2014	Periodic Reminder		
Channel 2			
Enter the time period that must be passed since the last calibration before the time reminder will appear.			
days	hours	minutes	
00	01	00	
Press <Escape> to exit to previous screen. Press <Edit> to edit the focused entry. Press <Next> or <Previous> to select entry.			
Escape	Edit	Next	Previous

03:53:07 PM Dec 15, 2014	Edit Cell Constant		
Channel 2			
Edit custom value of cell constant:			
1.0000	/cm		
Limit Low:	0.0500/cm		
Limit High:	200.00/cm		
Use <Up> and <Down> arrows to set value.			
Press <Accept> to save the current value. Press <Escape> to exit to previous screen.			
Escape	Accept	Δ	∇













- Press  to access the **Cell Constant** menu.
- Press  to reset the cell constant value to default (1.0000/cm).
- Use  /  to increase / decrease the value.
- Press  to confirm the new value or press  to exit without modifying.

Probe Type

This option allows the user to obtain some information about the connected conductivity probe: name, default cell constant, range and rings number. The **HI76312** probe is recognized by the meter.

Units

The user can select the desired measurement unit. The available options are: $\mu\text{S}/\text{cm}$, mS/cm or AutoRanging.

- Press  while in **Conductivity** mode.
- Press .
- Use  or  to highlight the Calibration option.
- Press  and then use  or  to highlight the **Units** option.
- Press  and then use  or  to select $\mu\text{S}/\text{cm}$, mS/cm or AutoRanging.
- Press  to confirm your selection or press  to cancel operation.

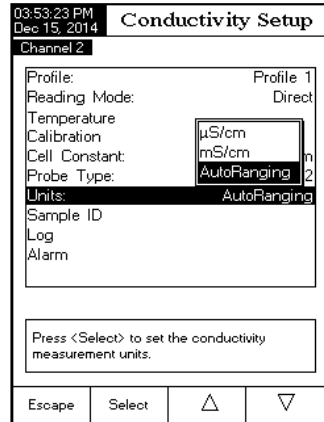

Sample ID

This option allows the user to assign an identification number/name to sample logs. Two Sample ID parameters are available: ID Increment mode and Edit Sample ID.

ID Increment

Choose **None** to identify a sample with a text tag.
 Choose **Automatic** to identify a sample with a numeric tag.
 This number will be incremented by one for each new lot log but it can also be altered manually here. This number does not increment for each manual log sample. This will be automatically incremented when a New Lot will be selected.
 To select the **ID increment** mode:

- Press  while in **Conductivity** mode.

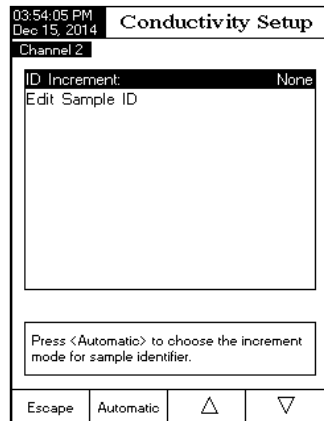

- Press **Cond. Setup**
- Use **Δ** or **∇** to highlight the **Sample ID** option.
- Press **Select** and then use **Δ** or **∇** to highlight the **ID Increment** option.
- Press **None** or **Automatic** as desired.
- Press **Escape** to return to previous menu.

Edit Sample ID

This option allows the user to edit the Sample ID. If ID Increment is None, a Text Editor screen is displayed. If ID Increment is Automatic, a Numeric Editable screen is displayed.

To access the **Sample ID**:

- Press **SETUP** while in **Conductivity** mode.
- Press **Cond. Setup**
- Use **Δ** or **∇** to highlight the **Sample ID** option.
- Press **Select** and use **Δ** or **∇** to highlight the **Edit Sample ID** option.
- Press **Select** to confirm your selection.
- For text editing use **▶** and **∇** to highlight the desired character and then press **Select** to add it to the text bar. It is also possible to delete the last character by positioning the cursor on the Backspace character (⌫) and pressing **Select**.
- Press **Escape** to return to Sample ID option. If the Saving Confirmation is enabled, press **Yes** to accept the modified option, **No** to escape without saving, or **Cancel** to return to the editing mode. Otherwise, the modified options are saved automatically.
- For numeric editing use **Δ** or **∇** keys.
- Press **Accept** to save the current value or press **Escape** to cancel operation.

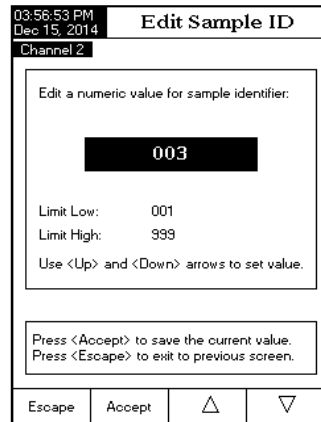
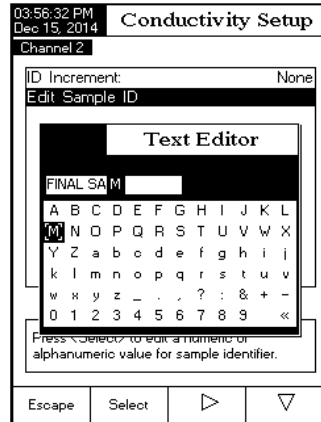

Log

Note: See Logging section for available types of logging.

This option allows the user to edit the log settings: Logging Type, Logging Data Configuration, Sampling Period and New Lot.

Logging Type

Three logging types are available: Automatic, Manual and Auto Hold.

Automatic - the measurement data is logged automatically at constant time intervals.

Manual - a snapshot of the displayed measurement data is logged with time stamp when the user manually depresses Log.

Auto Hold - this is configured along with the Direct/AutoHold reading mode to take a snapshot of stable measurement data. Press Start Log to initiate a logging session. Press Auto Hold to initiate an Auto Hold event. The log occurs automatically once measurement stability is reached. This type log removes subjective data, as it only captures stable measurements.

To set the **Logging Type**:

- Press SETUP while in **Conductivity** mode.
- Press Cond. Setup
- Use Δ or ▽ to highlight the **Log** option.
- Press Select and use Δ or ▽ to highlight the **Logging Type** option.
- Press Select and use Δ or ▽ to highlight the desired option.
- Press Select to confirm your selection or press Escape to cancel operation.

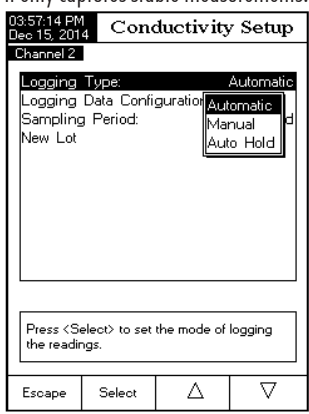

Logging Data Configuration

This option allows the user to select which parameters will accompany a log File: Date/Time, Calibration Data, Sample ID, Instrument ID, Operator ID, Company Name, Additional Info 1 and Additional Info 2.

To set the **Logging Data Configuration**:

- Press SETUP while in **Conductivity** mode.
- Press Cond. Setup
- Use Δ or ▽ to highlight the **Log** option.
- Press Select and use Δ or ▽ to highlight the **Logging Data Configuration** option.

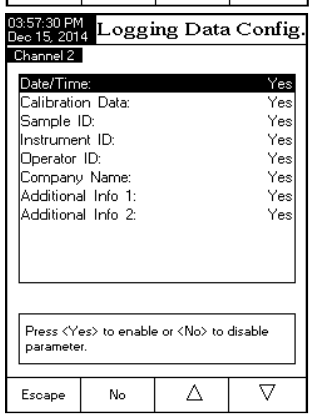

- Press and use or to highlight the desired parameter to be logged in file.
- Press to enable the parameter or to disable it.
- Press to return to previous menu.

Sampling Period

This option allows the user to select the desired sampling period for automatic logs.

To set the **Sampling Period**:

- Press while in **Conductivity** mode.
- Press .
- Use or to highlight the **Log** option.
- Press and use or to highlight the **Sampling Period** option.
- Press and use or to select the desired option.
- Press to confirm your selection or press to cancel operation.

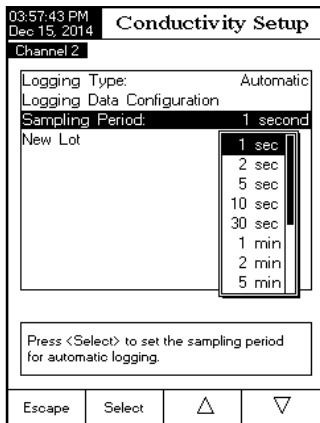

New Lot

This option is used to create a new lot when manual logging is used.

Note: If New Lot option is accessed and the Logging Type is Automatic, a warning message appears on the LCD informing the user that a new lot can be created only if the Logging Type is set as Manual.

To generate a **New Lot**:

- Press while in **Conductivity** mode.
- Press .
- Use or to select the **Log** option.
- Press and use or to highlight the **New Lot** option.
- Press to generate a new manual lot. A pop-up menu will be displayed asking for confirmation.
- Press to confirm or press to escape without saving and return to the Log options.

Alarm

This option allows the user to select the alarm settings: Alarm State and Alarm Limits. If the Alarm option is enabled, a continuous double beep will be heard, along with the “Alarm” indicator blinking on the LCD, each time the set limits in Measure mode are exceeded.

Note: Alarm Beeper must be set On for audible beep to be heard. See: System Setup → Beeper → Alarm.

Alarm State

Three settings are available for the Alarm State option:

Disabled - the alarm will be disabled.

Inside Limits - the alarm state will trigger when the measured value is inside the set limits.

Outside Limits - the alarm state will trigger when the measured value is outside the set limits.

To set the **Alarm State**:

- Press **SETUP** while in **Conductivity** mode.
- Press **Cond. Setup**.
- Use **Δ** or **∇** to select the **Alarm** option.
- Press **Select** and use **Δ** or **∇** highlight the **Alarm State** option.
- Press **Select** and use **Δ** or **∇** to highlight the desired option.
- Press **Select** to confirm your selection or press **Escape** to cancel operation.

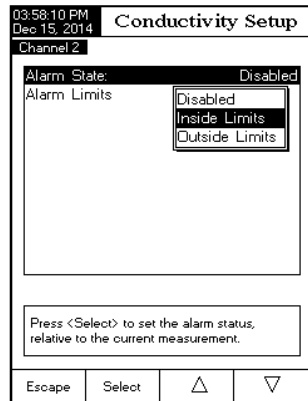

Alarm Limits

This option allows the user to set the alarm limits for the measured value.

Note: The Alarm High value can not be lower than the Alarm Low value.

- Press **SETUP** while in **Conductivity** mode.
- Press **Cond. Setup**.
- Use **Δ** or **∇** to select the **Alarm** option.
- Press **Select** and use **Δ** or **∇** highlight the **Alarm Limits** option.
- Press **Edit** and then use **Δ** or **∇** to set the desired value, then press **Accept** to save the modified value or press **Escape** to cancel operation.
- Press **Escape** to return to the Alarm options.

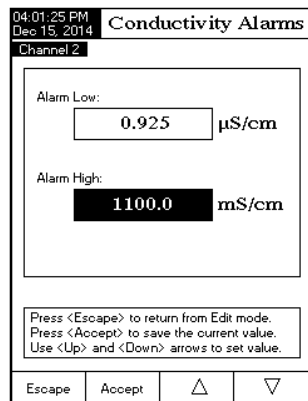

The **Resistivity Setup** menu allows the user to set the parameters related to resistivity measurements. The parameter must be set on Channel 2.

Accessing Resistivity Setup

- Press **MODE** and then **Resistiv.** to select resistivity measurement mode.
- Press **SETUP** and then **Resistiv. Setup** to access **Resistivity Setup** menu.

To access a **Resistivity Setup** option:

- Use **Δ** or **∇** to select the desired option.
- Press **Select** to confirm your selection.

03:43:44 PM Dec 15, 2014		Measure	
Channel 1		Profile 1	Stable
		6.806	pH
Last Cal.: Dec 15, 2014 11:58 AM		ATC1 26.0°C	
Electrode Cond.: 100%			
Channel 2		Profile 2	Stable
		202	Ω.cm
Cell Constant: 1.1486/cm		ATC2 23.7°C	
Choose Setup Mode, Log Recall or Escape			
Escape	Log Recall	Resistiv. Setup	System Setup

The following is a description of the **Resistivity Setup** option screens.

Profile - see **Conductivity Setup** section.

Reading Mode

This option allows the user to select between Direct and Direct/AutoHold resistivity function. If choosing the second option, the current reading can be frozen on the LCD when **Auto Hold** is pressed and the stability criterion is reached.

To set the **Reading Mode**:

- Press **SETUP** while in **Resistivity** mode.
- Press **Resistiv. Setup**.
- Use **Δ** or **∇** to highlight the **Reading Mode** option.
- Press **Direct** / **AutoHold** to select Direct / Direct/AutoHold option as desired.
- Press **Escape** to cancel operation.

04:05:00 PM Dec 15, 2014		Resistivity Setup	
Channel 2		Profile: Profile 2	
		Reading Mode: Direct	
Temperature			
Units:		AutoRanging	
Sample ID			
Log			
Alarm			
Press <AutoHold> to choose the reading mode for measurements.			
Escape	AutoHold	Δ	∇

Temperature - see **Conductivity Setup** section.

Units

The user can choose between Ω .cm, $K\Omega$.cm, $M\Omega$.cm or AutoRanging units.

To select the **units**:

- Press **SETUP** while in Resistivity mode.
- Press **Resistiv. Setup**
- Use **Δ** or **∇** to highlight the **Units** option.
- Press **Select** to confirm and then use **Δ** or **∇** to highlight the desired unit.
- Press **Select** to confirm or press **Escape** to cancel operation.

04:05:14 PM Dec 15, 2014		Resistivity Setup					
Channel 2							
Profile:	Profile 2						
Reading Mode:	Direct						
Temperature							
Units:	AutoRanging						
Sample ID	<table border="1"> <tr> <td>Ω.cm</td> </tr> <tr> <td>$K\Omega$.cm</td> </tr> <tr> <td>$M\Omega$.cm</td> </tr> <tr> <td>AutoRanging</td> </tr> </table>			Ω .cm	$K\Omega$.cm	$M\Omega$.cm	AutoRanging
Ω .cm							
$K\Omega$.cm							
$M\Omega$.cm							
AutoRanging							
Log							
Alarm							
Press <Select> to set the resistivity measurement units.							
Escape	Select	Δ	∇				

Sample ID - see **Conductivity Setup** section.

Log - see **Conductivity Setup** section.

Alarm - see **Conductivity Setup** section.

The **TDS Setup** menu allows the user to set the parameters related to the TDS measurement. This parameter must be set on Channel 2.

Accessing TDS Setup

- Press **MODE** and then **TDS** to select TDS (Total Dissolved Solids) measurement mode.
- Press **SETUP** and then **TDS Setup** to access TDS Setup menu.

To access a **TDS Setup** option:

- Use **△** or **▽** to highlight the desired option.
- Press **Select** to access the selected option.

The following is a description of the **TDS Setup** option screens.

Profile - see **Conductivity Setup** section.

Reading Mode - see **Resistivity Setup** section.

Temperature - see **Conductivity Setup** section.

Units

This option allows the user to set the TDS measuring unit ppm (mg/L), ppt (g/L) or AutoRanging units.

To select the suitable **unit**:

- Press **SETUP** while in TDS mode.
- Press **TDS Setup**.
- Use **△** or **▽** to highlight the **Units** option.
- Press **Select** to confirm and then use **△** or **▽** to highlight the desired unit.
- Press **Select** to confirm your selection or press **Escape** to cancel operation.

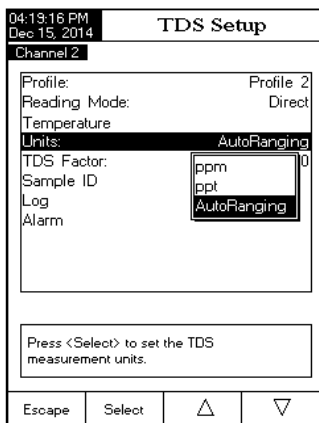
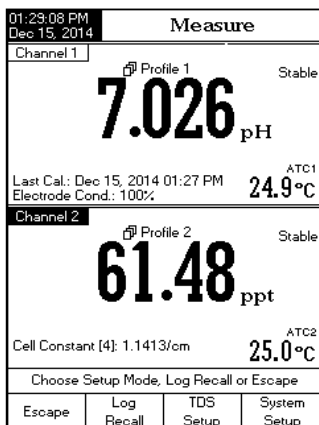

TDS factor

TDS factor is a conversion factor used to convert conductivity to TDS by the equation: $TDS = \text{Factor} \times EC_{25}$. The TDS conversion factor can be set from 0.40 to 1.00. A typical TDS conversion factor for a strong ionic solutions is 0.50, while for a weak ionic solutions (e.g. fertilizers) is 0.70.

Example:

$$\begin{aligned} & \text{TDS factor} \\ & 0.5 \mu\text{S}/\text{cm} \times 0.41 = 0.205 \text{ ppm NaCl} \end{aligned}$$

The default value is 0.50.

This option allows the user to set the **TDS factor**:

- Press **SETUP** while in **TDS** mode.
- Press **TDS Setup**.
- Use **△** or **▽** to highlight the **TDS Factor** option.
- Press **Select** to confirm your selection and use **△** or **▽** to increase / decrease the value.
- Press **Select** to confirm your selection or press **Escape** to cancel operation.

04:18:30 PM Dec 15, 2014	TDS Factor		
Channel 2			
Edit TDS Factor :			
0.50			
Limit Low:	0.40		
Limit High:	1.00		
Use <Up> and <Down> arrows to set value.			
Press <Accept> to save the current value. Press <Escape> to exit to previous screen.			
Escape	Accept	△	▽

Sample ID - see **Conductivity Setup** section.

Log - see **Conductivity Setup** section.

Alarm - see **Conductivity Setup** section.

Salinity measurements are related to the salt in ocean water.

The **Salinity Setup** menu allows the user to set the parameters related to Salinity measurement and calibration. These parameters must be set for Channel 2.

Accessing Salinity Setup

- Press **MODE** and then **Salinity** to select Salinity measurement mode.
- Press **SETUP** and then **Salinity Setup** to access Salinity Setup menu.

To access a **Salinity Setup** option:

- Use **Δ** or **∇** to highlight the desired option.
- Press **Select** to access the selected option.

The following is a description of the **Salinity Setup** option screens.

Profile - see **Conductivity Setup** section.

Reading Mode - see **Resistivity Setup** section.

Temperature

To set one of the **Temperature** options:

- Press **SETUP** while in **Salinity** mode.
- Press **Salinity Setup**.
- Use **Δ** or **∇** to highlight the **Temperature** option.
- Press **Select** and then use **Δ** or **∇** to highlight the desired **Temperature** option you wish to modify.
- Press **Select** and then use **Δ** or **∇** to highlight the desired option (for Temperature Source & Unit options) or use **Δ** or **∇** to adjust the temperature value between the displayed limits (for Manual Temperature option).
- Press **Select** to confirm your selection (for Temperature Source & Unit options) or press **Accept** to save the current value (for Manual Temperature option). Otherwise, press **Escape** to cancel operation.

04:22:25 PM Dec 15, 2014		Measure	
Channel 1	Profile 1	Stable	
7.015		pH	
Last Cal.: Dec 15, 2014 11:58 AM		ATC2 21.1 °C	
Electrode Cond.: 100%			
Channel 2	Profile 2	Stable	
0.2		%	
Default Calibration		ATC2 21.1 °C	
Cell Constant [1]: 1.1144/cm			
Choose Setup Mode, Log Recall or Escape			
Escape	Log Recall	Salinity Setup	System Setup

Clear Calibration

This function only works for the Percent Scale.

To clear calibration:

- Press **SETUP** while in **Salinity** mode.
- Press **Salinity Setup**.
- Use **△** or **▽** to highlight the **Clear Calibration** option.
- Press **Select** to clear calibration. A pop-up menu will be displayed to ask for confirmation (if calibration is available).
- Press **Yes** to confirm or press **No** to cancel operation.

Salinity Scale

Note: See Salinity Measurement for a description of these scales.

The meter has three ocean salinity scales: Natural Sea Water 1966, Practical Scale 1978, Percent Scale [%].

To select the desired salinity measurement scale:

- Press **SETUP** while in **Salinity** measure mode.
- Press **Salinity Setup**.
- Use **△** or **▽** to highlight the **Salinity Scale** option.
- Press **Select** and use **△** or **▽** to highlight the desired option.
- Press **Select** to confirm your selection or press **Escape** to cancel operation.

04:22:48 PM Dec 15, 2014		Salinity Setup	
Channel 2			
Profile:	Profile 2		
Reading Mode:	Direct		
Temperature			
Clear Calibration			
Salinity Scale:	Percent Scale [%]		
Sample ID	Natural Sea Water 1966		
Log	Practical Scale 1978		
Alarm	Percent Scale [%]		
Press <Select> to change the salinity scale type.			
Escape	Select	△	▽

Sample ID - see **Conductivity Setup** section.

Log - see **Conductivity Setup** section.

Alarm - see **Conductivity Setup** section.

For optimum measurements:

- Insert probe in the center of the beaker away from container bottom or walls.
- Fix the probe so it does not move during measurements and add sufficient solution to cover top vent holes on probe.
- Gently stir solution and wait for probe to reach thermal equilibrium and verify no bubbles are entrapped within probe electrodes.

It is recommended to calibrate the instrument frequently, especially if high accuracy is required.

The conductivity range should be recalibrated:

- Whenever the conductivity probe is replaced.
- At least once a week.
- Before USP measurements.
- After testing aggressive chemicals.
- When calibration reminder is activated (“Conductivity Cal Expired”).
- If the readings are far from the calibration point.

Note: TDS, Resistivity, Natural Sea Water and Practical Sea Water Salinity readings are automatically derived from the conductivity readings so conductivity calibration is required.

OFFSET CALIBRATION

The meter allows the user to calibrate the probe for an offset.

- Select Channel 2 and press **MODE** and then press **Cond.**
- Select the automatic standard recognition (see Conductivity Setup → Calibration).
- Leave the dry probe in the air (infinite resistance).
- Enter in calibration mode by pressing **CAL**.
- Clear any previous calibrations by pressing **Clear Cal**.
- Wait to stabilize. The 0.000 $\mu\text{S}/\text{cm}$ calibration point will appear on the screen.
- Press **Accept** to finish the probe offset calibration.
- Press **Escape** to exit calibration mode or continue calibration in the other standard solutions.

Note: The offset calibration can be performed only if it is performed first (no other calibration points present). Clear the old calibration if it is present.

CELL CONSTANT CALIBRATION (in solution)

Single-Point Calibration

- Select the single point calibration (see Conductivity Setup → Calibration).

- Pour a small quantity of the standard solution into a clean beaker. If possible, use plastic beakers to minimize any EMC interferences.
- For accurate calibration and to minimize cross-contamination, use two beakers for each standard solution. One for rinsing the probe and one for calibration.
- Insert the probe in the rinse beaker.
- Swirl probe in this solution. Raise and lower 3 times to fill cell with solution.
- Insert the probe in the second beaker.
- Swirl and tap probe to remove air bubbles. Raise and lower 3 times to ensure representative sample.
- Enter calibration mode by pressing .
- Wait to stabilize.
- If automatic standard recognition was selected in Setup, a calibration point will be automatically displayed from the Hanna standard list (84 $\mu\text{S}/\text{cm}$, 1413 $\mu\text{S}/\text{cm}$, 5.0 mS/cm , 12.88 mS/cm , 80.0 mS/cm , 111.8 mS/cm). The user can also select another standard value by using and .
- If User Standard was selected in Setup, a pop-up will prompt for the custom standard value.
- Press to finish the calibration or to abort calibration.
- The probe should be rinsed in deionized water.
- Shake off excess water.

Note: The calculated cell constant will be used for the whole range.

Multi-Point Calibration

- Up to 4 calibration points can be performed in order to increase the measurement accuracy over a larger measurement range.
- Select the multi point calibration (see Conductivity Setup → Calibration).
- Repeat the steps from the single point calibration for each measurement range. The meter will calculate a cell constant corresponding to each calibration point.
- Press to exit calibration mode.

Note: For each range the corresponding cell constant will be displayed.

CELL CONSTANT CALIBRATION (edited by the user)

- A known value of the probe cell constant can be set by the user for the whole range (see Conductivity Setup → Cell Constant section). Using a known cell constant is another way to calibrate the meter/probe system.

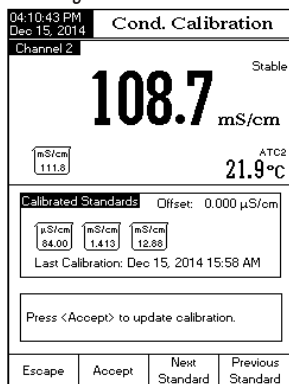

Note: When a cell constant value is used, the solution calibration will be cleared. A solution calibration can still be made after entering a cell constant value.

CALIBRATION MESSAGES

- **Wrong standard solution. Check the standard solution.** This message appears when the difference between the reading and the value of the selected standard is significant. If this message is displayed, check if you have selected the appropriate calibration standard.
- **Wrong standard temperature.** This message appears if the standard temperature is out of the allowable standard temperature range (0 - 60 °C).
- **The current range was already calibrated. Change the standard solution.** The calibration for this conductivity range was already done. Please change the standard.
- **Press <Clear Offset> to clear old calibration.** Clear the offset of the electrode calibration.
- **Press <Clear Cal> to clear old calibration.** Clear all old calibrated standards.

Make sure the instrument has been calibrated before taking conductivity measurements.

DIRECT MEASUREMENT



To measure the conductivity of a sample using the Direct reading mode:

- Highlight Channel 2 and press **MODE** and then **Cond.** to select conductivity measure mode.
- Select the Direct reading mode (see Conductivity Setup).
- The conductivity probe should be rinsed with deionized water.
- Shake off excess water.
- If possible rinse probe with a sample of solution to be tested. Swirl and raise and lower probe in this rinse solution.
- Insert probe in center of a beaker with the sample, away from the wall or bottom of beaker. The upper vent holes must be covered with solution.
- Gently stir solution and wait for probe to reach thermal equilibrium with the sample.
- Tap probe repeatedly to dislodge any air bubbles that may be trapped inside the sleeve. Allow time for the reading to stabilize.
- The measured conductivity value will be displayed on the Channel 2 screen.









DIRECT/AUTOHOLD MEASUREMENT

To measure conductivity of a sample using the Direct/AutoHold reading mode:

- Follow sample and probe directions found under Direct Measurement.
- Select the Direct/AutoHold reading mode (see Conductivity Setup).
- If pressing , the "AutoHold" indicator will start blinking on the display until the stability criterion is reached. The conductivity value will be frozen on the display, along with "AutoHold" indicator.
- To return to normal measure mode press .

The United States Pharmacopoeia Regulations establishes limits and calibration requirements for WFI (Water For Injection). The [HI5521](#) and [HI5522](#) meters contains both conductivity and pH measurements that are needed for off line measurements in a Stage 2 and 3 of the regulation. Stage 1 verification may be carried out in a container but the regulation requires an in-line measurement. The meter provides prompts and instructions to make the measurements easily. Calibrate a pH sensor on Channel 1 and EC probe on Channel 2 prior to storing USP analysis.

To access the **USP menu**:

- Highlight Channel 2 and select  from the basic display to select .
- Press  then .
- Select the Direct/USP reading mode (see Conductivity Setup).
- Return to measure mode by pressing .
- Verify conductivity probe has been calibrated in conductivity standards in the lowest measurement range.
- Press  and then select the desired USP stage.

In this measure mode the user can check for water quality using the United States Pharmacopoeia standard (USP <645>) guidelines for water for injection.

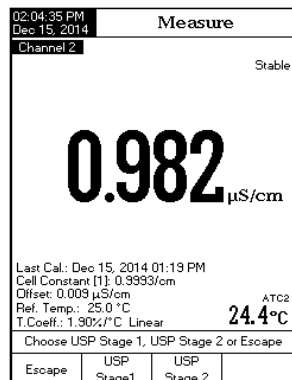
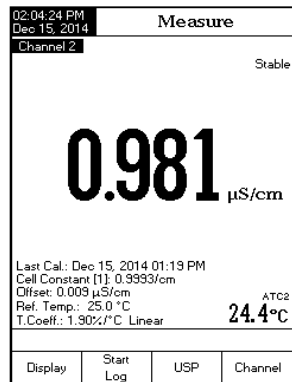
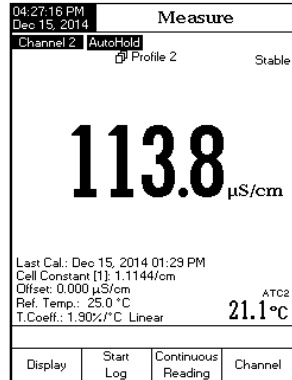

This USP standard consists of three stages (one in-line and two off-line tests) as followings:

Stage 1 - this is an in-line test.

The procedure follows:

- Measure the temperature of the water and the absolute conductivity readings. The measurement must be on in-line measurement. Results may be verified using a laboratory method.
- The temperature should be rounded down to the nearest 5 °C. Look up the corresponding conductivity value in the table below.
- If the measured conductivity is lower than the conductivity in the table, then the water meets the USP requirements.
- Otherwise, proceed to Stage 2 testing.



Temperature (°C)	Conductivity (μS/cm)	Temperature (°C)	Conductivity (μS/cm)	Temperature (°C)	Conductivity (μS/cm)
0	0.6	35	1.5	70	2.5
5	0.8	40	1.7	75	2.7
10	0.9	45	1.8	80	2.7
15	1.0	50	1.9	85	2.7
20	1.1	55	2.1	90	2.7
25	1.3	60	2.2	95	2.9
30	1.4	65	2.4	100	3.1

Stage 1 steps:

Press **USP Stage 1** from the keypad.

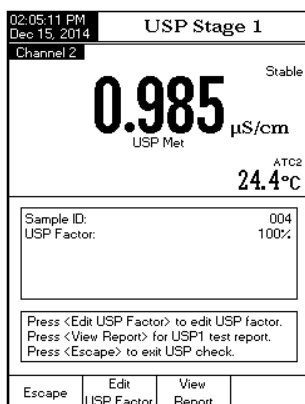
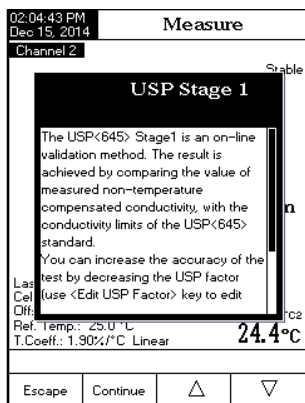
- An instruction prompt will pop up.
- Using measurement technique outlined in direct measurement, place probe into sample.
- Press **Continue**.
- The user may Edit the USP factor (to provide a margin of error) or compare measurement results directly to the standard (100%). "Please wait ..." will appear on display and the measurement is compared to the standard values.



- At the conclusion of the test period the results will be displayed.
- The user may View the results as a report. Press .
- A copy of the sample results may also be saved. Press . This may be printed using HI92000 software.

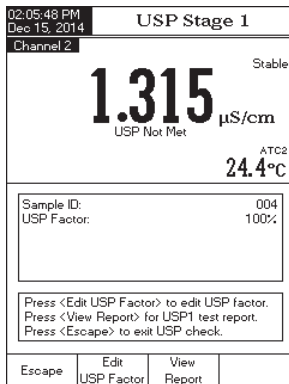



Stage 2 - this is an off-line test.

To perform this test:

- Store the water sample in an enclosed clean container that has been rinsed previously with water of the same quality.
- Adjust the sample's temperature to 25 °C and agitate the sample to ensure that it has equilibrated with ambient CO₂.
- If the measured conductivity is less than 2.1 µS/cm, then the sample has met the USP requirements.
- Otherwise, proceed to Stage 3 testing.

Stage 2 steps:

Note: A temperature bath at 25.0 ± 1.0 °C is required for this measurement.

- Press  from the keypad.
- An instruction prompt will pop up with instructions for sample preparation.
- Using measurement technique outlined in direct measurement, place probe into sample.
- Press .
- The meter will begin to evaluate stability of the conductivity measurement. At the conclusion of the test period the results will be displayed. If the sample has passed the evaluation the testing is finished and the water may be used.
- Press  to store a copy of the sample results. This may be printed using HI92000 software.

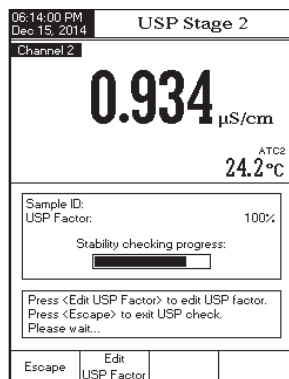
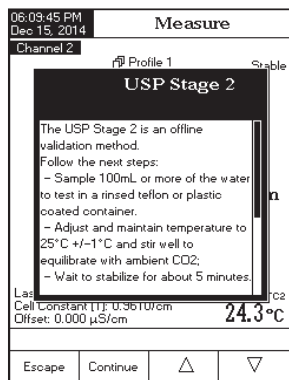

Stage 3 - this is an off-line test that studies the pH and CO₂. If the water sample has failed Stage 1 and Stage 2 tests, Stage 3 testing must be conducted.

To perform this test use Channel 1 in pH mode. Have a calibrated pH sensor installed.

Note: A temperature bath at 25.0 ± 1.0 °C is required for this measurement.

- Take the water sample from the stage 2 test and increase its ionic strength for a pH measurement at 25 °C.
- Use 100 mL of Stage 2 water and add 300 µL saturated KCl to the sample.
- Calibrate a pH sensor in pH 4.010 and pH 6.862 (or 7.01) buffers.
- Thermally equilibrate the sample to 25.0 ± 1.0 °C.
- Measure sample with the calibrated pH sensor.
- The pH of sample must be between 5.0 and 7.0 pH.
- Record the pH and round it to the nearest 0.1 pH.
- Find the measured pH and corresponding conductivity in the stage 3 table below.
- Compare the conductivity value determined in stage 2 to the conductivity value found in the stage 3 table.
- If the stage 2 conductivity is lower than the conductivity from the table below, the sample has meet the USP requirements. Otherwise, the water didn't meet the USP requirements.

Note: If the Stage 2 water fails, the meter automatically changes to pH and starts Stage 3 evaluation. Having 25 °C sample with added ionic salt is required. At the conclusion at Stage 3 evaluation, press Save to store a report of the results. The report may be printed using HI92000 software.

06:42:32 PM Dec 15, 2014	USP Results
USP<645> Not Met	
Sample ID:	
USP Stage 2	USP<645> Not Met
Conductivity:	2.118µS/cm
Temperature:	24.2 °C, A
USP Factor:	100%
Time:	Dec 15, 2014 06:40:40 PM
Press <Save> to save USP check report. Press <USP Stage 3> to start Stage 3 test. Press <Escape> to exit USP check report.	
Escape	Save
	USP Stage 3

pH	Conductivity (µS/cm)	pH	Conductivity (µS/cm)	pH	Conductivity (µS/cm)
5.0	4.7	5.7	2.5	6.4	2.3
5.1	4.1	5.8	2.4	6.5	2.3
5.2	3.6	5.9	2.4	6.6	2.1
5.3	3.3	6.0	2.4	6.7	2.6
5.4	3.0	6.1	2.4	6.8	3.1
5.5	2.8	6.2	2.5	6.9	3.8
5.6	2.6	6.3	2.4		

Make sure the instrument and probe has been calibrated in conductivity mode before taking resistivity measurements.

DIRECT MEASUREMENT

To measure the resistivity of a sample using the **Direct** reading mode:

- Press **MODE** and then **Resistiv.** to select resistivity measure mode.
- Select the **Direct** reading mode (see Resistivity Setup section).
- Proceed the same as for the conductivity measurement (see Conductivity Measurement section).

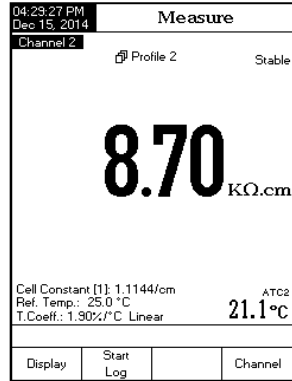

DIRECT/AUTOHOLD MEASUREMENT

To measure resistivity of a sample using the **Direct/AutoHold** reading mode:

- Select the **Direct/AutoHold** reading mode (see Resistivity Setup section).
- Proceed the same as for the conductivity measurement (see Conductivity Measurement section).

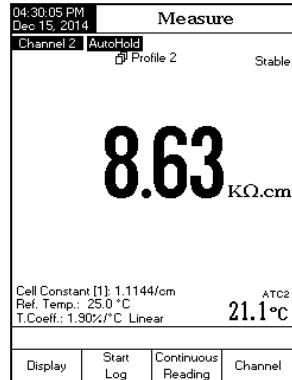

Make sure the TDS factor has been set before taking TDS measurements (see TDS Setup section). Also the TDS calibration is made in Conductivity mode.

DIRECT MEASUREMENT

To measure the TDS of a sample using the **Direct** reading mode:

- Press **MODE** and then **TDS** to select TDS measure mode.
- Select the **Direct** reading mode (see TDS Setup section).
- Proceed the same as for the conductivity measurement (see Conductivity Measurement section).

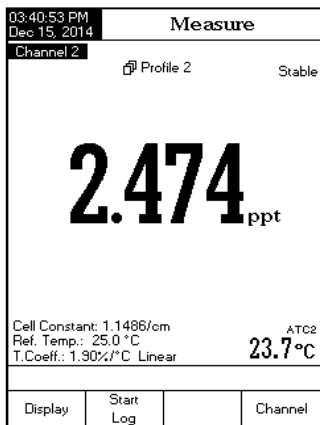

DIRECT/AUTOHOLD MEASUREMENT

To measure TDS of a sample using the **Direct/AutoHold** reading mode:

- Select the **Direct/AutoHold** reading mode (see TDS Setup section).
- Proceed the same as for the conductivity measurement. (see Conductivity Measurement section).



Note: Salinity calibration is made in conductivity mode when using Natural Sea Water or Practical Sea Water measurement. Direct salinity calibration is only possible when using the older percent scale.

Salinity calibration is a single-point calibration procedure at 100.0%. Use the [HI7037](#) calibration solution (salinity solution) as a 100% seawater solution.

To enter salinity calibration:

- Set the meter for salinity range.
- Select the Percent Scale (see Salinity Setup section).
- Rinse the probe with some of the calibration solution or deionized water.
- Immerse the probe in [HI7037](#) solution. The sleeve holes must be completely submerged. Tap the probe repeatedly to remove any air bubbles that may be trapped inside the sleeve. Position probe away from the wall or bottom of the container.
- Enter in calibration mode by pressing .
- Wait for measurement to stabilize.
- Press to finish salinity calibration or press to cancel calibration.

CALIBRATION MESSAGES

- **Wrong standard solution. Check the standard solution.** This message appears when the difference between the reading and the value of the selected standard is significant. If this message is displayed, check if you have selected the appropriate calibration standard.
- **Wrong standard temperature.** This message appears if the standard temperature is out of the allowable standard temperature range (0 - 60 °C).
- **Press <Clear Cal> to clear old calibration.:** Clear the old calibration.

Three methods for calculating seawater salinity are supported (Natural Sea Water Scale, Practical Salinity Scale and Percent Scale).

PERCENT SCALE (1902)

This salinity scale extends from 0.0 to 400.0%. The formula followed is:

$$S_{\%} = 1.805Cl + 0.03$$

where salinity is defined as the total amount of solid materials in grams dissolved in one kilogram of seawater. 100% Salinity has ~10% solids and is considered normal seawater.

NATURAL SEA WATER SCALE (UNESCO 1966)

The Natural Sea Water Scale extends from 0.00 - 80.00 ppt. It determines salinity based upon a conductivity ratio of sample to "standard seawater" at 15 °C.

$$R_{15} = \frac{C_T(\text{sample})}{C(35,15)} \cdot r_T \quad \text{where } R_{15} \text{ is the conductivity ratio, and Salinity is defined by the following equation.}$$

$$S = -0.08996 + 28.2929729R_{15} + 12.80832R_{15}^2 - 10.67869R_{15}^3 + 5.98624R_{15}^4 - 1.32311R_{15}^5$$

Note: The formula can be applied for temperatures between 10 °C and 31 °C.

PRACTICAL SALINITY SCALE (UNESCO 1978)

The PSU scale extends from 0.00-42.00. The Practical salinity (S) of seawater relates the ratio of electrical conductivity of a normal seawater sample at 15 °C and 1 atmosphere to a potassium chloride solution (KCl) with a mass of 32.4356 g/kg water at the same temperature and pressure. Under these conditions the ratio is equal to 1 and S=35. The Practical salinity scale may be applied to values 2 through 42 PSU at temperature between -2 °C to 35 °C.

S is defined in terms of the ratio K_{15} .

$$S = 0.0080 - 0.1692K_{15}^{1/2} + 25.3851K_{15} + 14.0941K_{15}^{3/2} - 7.0261K_{15}^2 + 2.7081K_{15}^{5/2}$$

$$K_{15} = \frac{C(S,15,0)}{C(KCl,15,0)}$$

Where C is Conductivity;

$$C(35,15,0) = 0.042933 \text{ S/cm}$$

The simplified equation above is derived from

$$S = a_0 + a_1 \cdot R_T^{1/2} + a_2 \cdot R_T + a_3 \cdot R_T^{3/2} + a_4 \cdot R_T^2 + a_5 \cdot R_T^{5/2} + \frac{(T-15)}{1+k(T-15)}$$

$$[b_0 + b_1 \cdot R_T^{1/2} + b_2 \cdot R_T + b_3 \cdot R_T^{3/2} + b_4 \cdot R_T^2 + b_5 \cdot R_T^{5/2}]$$

With the following coefficients and $k = 0.0162$ and

$$R = \frac{C_{(S,T,P)}}{C_{(35,15,10)}} = (R_p \cdot R_T \cdot r_T)$$

Seawater temperature coefficient $r_T = c_0 + c_1 \cdot T + c_2 \cdot T^2 + c_3 \cdot T^3 + c_4 \cdot T^4$

$$R_T = \frac{R}{R_p \cdot r_T} ; R_p = 1 + \frac{P \cdot (A_1 + A_2 \cdot P + A_3 \cdot P^2)}{1 + B_1 \cdot T + B_2 \cdot T^2 + B_3 \cdot R + B_4 \cdot R \cdot T}$$

$a_0 = 0.008$	$b_0 = 0.0005$	$A_1 = 2.070 \cdot 10^{-5}$	$c_0 = 6.766097 \cdot 10^{-1}$
$a_1 = -0.1692$	$b_1 = -0.0056$	$A_2 = -6.370 \cdot 10^{-10}$	$c_1 = 2.00564 \cdot 10^{-2}$
$a_2 = 25.3851$	$b_2 = -0.0066$	$A_3 = 3.989 \cdot 10^{-15}$	$c_2 = 1.104259 \cdot 10^{-4}$
$a_3 = 14.0941$	$b_3 = -0.0375$	$B_1 = 3.426 \cdot 10^{-2}$	$c_3 = -6.9698 \cdot 10^{-7}$
$a_4 = -7.0261$	$b_4 = 0.0636$	$B_2 = 4.464 \cdot 10^{-4}$	$c_4 = 1.0031 \cdot 10^{-9}$
$a_5 = 2.7081$	$b_5 = -0.0144$	$B_3 = 4.215 \cdot 10^{-1}$	
		$B_4 = -3.107 \cdot 10^{-3}$	

The user temperature calibration menu can be accessed during meter startup by simultaneously pressing three keys as shown in the drawing below. Press the keys after the short beep is heard at the meter power on. Keep all three keys pressed until Temp. Calibration menu appear.

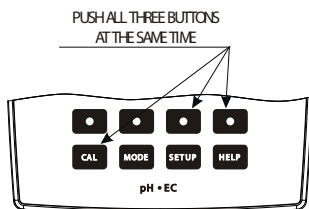

Note: The user temperature calibration is performed at three points: around 0 °C, 50 °C and 100 °C.

To perform the **user temperature calibration**:

- Select the desired temperature channel by pressing Channel (the temperature channel is switched between temperature EC channel and temperature pH channel).
- Press Start User Calib to start the temperature calibration. Adjust the temperature preset value using Δ or ▽ when necessary.
- Insert the EC probe into the beaker with water at 0 °C.
- Wait for measurement to stabilize and then press Accept to confirm the calibration point.
- Repeat the previous steps for 50 °C and 100 °C.
- Save the calibration.
- Press Escape to return to measure mode.

Note: Press Clear User Calib if you want to clear the temperature user calibration.

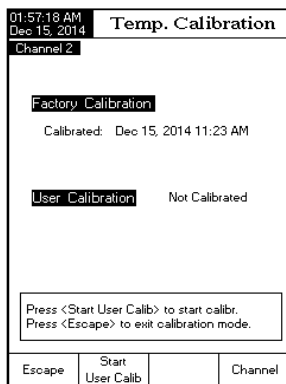

There are 5 ways the Reading Mode and Log may be configured together. The table below shows the combinations and indicates where the completed log will be stored.



Reading Mode	Log	log Recall
Direct	Automatic (1)	Automatic Log
	Manual (2)	Manual Log
	Auto Hold (NA)	Not Applicable
Direct/AutoHold	Automatic (3)	Automatic Log
	Manual (4)	Manual Log
	Auto Hold (5)	Manual Log

1) Direct Reading Mode and Automatic Log:

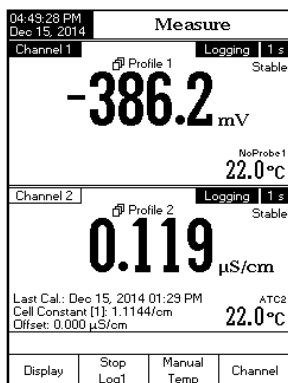
Real time continuous measurements are on display and continuous logs to meter memory. These are sometimes referred as interval logs. Press .



2) Direct Reading Mode and Manual Log:

Real time continuous measurements are on display and snapshots of measurement data are stored in the Manual log when the user presses . Subsequent snapshots will be added to the same Manual Lot every time the  is depressed unless **New Lot** is selected under Log options.

Note: When the  is pressed the lot ID along with the current record number will appear for short time on the selected channel window on the top/left corner (e.g. L033_MV 8 - this means lot ID L033_MV and record number 8).

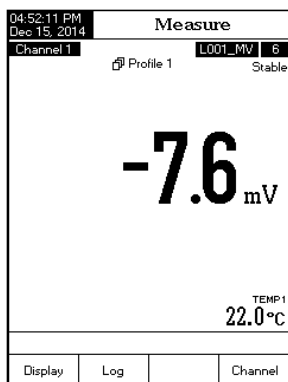

3) Direct/AutoHold Reading Mode and Automatic Log

Press Start Log and then Auto Hold keys must be pressed on front display to initiate this function. Real time continuous measurements are on display with “AutoHold” flashing and real time continuous logging into meter memory, until the meter reaches the stability criteria to go into AutoHold mode. The stored sample logs will be marked with an “H” to indicate the AutoHold mode. The virtual key Continuous Reading returns operation to real time continuous measurements and Stop Log stops the logging session.

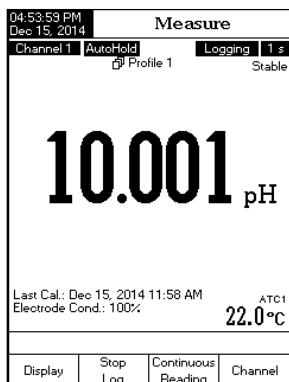

4) Direct/AutoHold Reading Mode and Manual Log

Press Log in order to add one new record in the log report. The manual log is working even if it is in Auto Hold or Continuous reading mode. Press Auto Hold to initiate the AutoHold event. “AutoHold” will flash until the stability criteria is reached and then the screen freezes in AutoHold mode, the data is marked with an “H”.

5) Direct/AutoHold Reading Mode and Auto Hold Log

Press Start Log and then Auto Hold keys to initiate and automate the capture of stable data which is stored in the Recall Manual Log file. During the process, “AutoHold” will flash until the stability criteria is reached and then the screen freezes in AutoHold mode, the data is logged and marked with an “H”. The virtual key Continuous Reading returns operation to Real time continuous measurement. Press Auto Hold again to log a second stable data point. The lot ID along with the record index will appear for short time on the top/left corner on the selected channel window, every time a record will be added to the lot.

LOG RECALL

This feature allows the user to view all stored data. If no data were logged, the “No records were found.” message will be displayed on the LCD in the Log Recall screen. Otherwise, the instrument will display all the memorized lots in accordance with the selected option: Automatic Log, Manual Log or ISE Method Report (HI5522 only) for Channel 1, or Automatic Log, Manual Log or USP Reports for Channel 2.

To view the **memorized data**:

- Press SETUP while in Measure mode.
- Press Log Recall. Choose channel and then select the log report type.

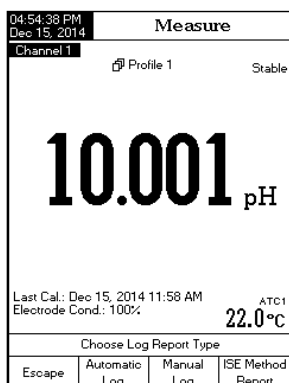

- Press **Automatic Log**, **Manual Log**, or **ISE Method Report** (HI5522 only) to select the desired Log Report type. All logged lots for the selected Log Report type will be displayed on the LCD.
- To filter the displayed lots, press **MODE** and then the desired parameter. Only the selected measurement parameter lots will be displayed on the LCD.
- Select the desired lot with **Δ** or **∇** and press **View** to display the logged data from the highlighted lot. The "Please wait..." message will be displayed on the LCD for one second. The selected Logging Data Configuration options will be displayed on the LCD, together with GLP information (last calibration date and calibrated buffers/standards) if a calibration has been performed on the selected mode and the logged values (measured value, mV value, temperature value, temperature compensation mode and the logging time).

Note: For automatic logging only, it is possible to view the plotted graph.

- Press **View Graph** to display the graph.
- By pressing **Shift Axes** it is possible to move the graph along the X or Y axis with the arrow keys.
- If pressing **SETUP** while the graph is displayed, the zoom menu for the X and Y axes will be accessed. Press **Zoom Time** or **Zoom pH** / **Zoom mV** / **Zoom Rel mV** / **Zoom ISE** / **Zoom Cond** / **Zoom Resistiv** / **Zoom TDS** / **Zoom Salinity** to switch between the active zooming axes and then zoom in or out on the selected axis by pressing the appropriate virtual key.
- Press **Escape** to return to the previous menu at any time.

05:04:11 PM
Dec 15, 2014 **Auto Log Recall**

L007_PH	<Dec 15, 2014 05:02:59 PM>
L006_PH	<Dec 15, 2014 04:59:39 PM>
L005_PH	<Dec 15, 2014 04:53:49 PM>
L004_MV	<Dec 15, 2014 04:49:11 PM>
L003_ISE	<Dec 15, 2014 03:18:00 PM>
L002_PH	<Dec 15, 2014 01:37:24 PM>
L001_ISE	<Dec 15, 2014 01:32:47 PM>

Press <View> to view selected lot.
Press <SETUP> to change options.
Press <MODE> to filter log lots.

Escape	View	Δ	∇
--------	------	---	---

05:04:25 PM
Dec 15, 2014 **Log Report**

Log Lot:	L007_PH / Channel 1		
Log Type:	Automatic		
Company Name:	HANNA		
Date & Time:	Dec 15, 2014	05:02:59 PM	
Instrument ID:	GC_CH-1		
Operator ID:	GIZELLA		
Sample ID:	003		
Additional Info 1:	Lot 3593		
Additional Info 2:			
Last Calibration:	Dec 15, 2014	04:59PM	
Calibrated Buffers			

Index	pH	mV	Slope[%]	Temp[°C]	Src
1.	4.010	171.8	59.3	22.0	A
					Hanna Dec 15, 2014 04:59:24PM
2.	7.010	-2.8	99.9	22.0	A
					Hanna Dec 15, 2014 04:59:09PM
3.	10.010	-173.5	99.9	22.0	A
					Hanna Dec 15, 2014 04:59:34PM

Index	pH	mV	Temp[°C]	Time
1	9.831	-167.3	22.0	A 05:02:59PM
2	9.831	-167.3	22.0	A 05:03:00PM
3	9.831	-167.3	22.0	A 05:03:01PM

Escape	View Graph	Δ	∇
--------	------------	---	---

05:04:39 PM
Dec 15, 2014 **Log Report**

Log Lot:	L007_PH / Channel 1		
Log Type:	Automatic		
Company Name:	HANNA		
Date & Time:	Dec 15, 2014	05:02:59 PM	
Instrument ID:	GC_CH-1		
Operator ID:	GIZELLA		
Sample ID:	003		
Additional Info 1:	Lot 3593		
Additional Info 2:			

Graph View

Press <SETUP> to select Zoom mode

2	9.831	-167.3	22.0	A 05:03:00PM
3	9.831	-167.3	22.0	A 05:03:01PM

Escape	Shift Axis	◀	▶
--------	------------	---	---

To delete lots:

- Press **SETUP** while in **Log Recall** mode.
- Press **Delete** or **Delete All** to access delete or delete all mode. Otherwise, press **View** to return to **Log Recall** view mode.
- After selecting one of the Delete keys, use **Δ** or **▽** to select one lot and then press **Delete** or **Delete All** to delete the selected lot or all lots. The “Please wait...” message will be displayed on the LCD until the selected lot or all lots are deleted.
- Press **SETUP** and then press **View** to exit deleting mode and return to Log Recall view mode.
- Press **Escape** to exit Log Recall mode and return to Measure mode.

05:04:15 PM Dec 15, 2014		Auto Log Recall
L007_PH	<Dec 15, 2014 05:02:59 PM>	
L006_PH	<Dec 15, 2014 04:53:33 PM>	
L005_PH	<Dec 15, 2014 04:53:43 PM>	
L004_MV	<Dec 15, 2014 04:49:11 PM>	
L003_ISE	<Dec 15, 2014 03:18:00 PM>	
L002_PH	<Dec 15, 2014 01:37:24 PM>	
L001_ISE	<Dec 15, 2014 01:32:47 PM>	
Press <View> to select view mode. Press <Delete> for delete mode. Press <Delete All> for delete all mode.		
	View	Delete Delete All

Note: Logged lots should also be deleted whenever “Limited Automatic Logging Space” or “Automatic Log Is Full” message appears on the LCD, in the Reminder messages area.

Data transmission from the instrument to the PC can be done with the **HI92000** Windows® compatible software (optional). **HI92000** also offers graphing and on-line help features.

Data logged on the **HI5521** and **HI5522** meters can be exported to the most popular spreadsheet applications for further analysis.

HI5521 and **HI5522** instruments have an USB interface.

Use a standard USB cable to connect your instrument to the PC.

Make sure that the instrument and the **HI92000** software have the same baud rate and the appropriate communication port.

The PC software may also be used for real time logging.

ISE THEORY

An Ion Selective Electrode (ISE) is an electrochemical sensor that changes voltage with the activity or concentration of ions in solutions. The change in voltage is a logarithmic relationship with concentration, and is expressed by the Nernst equation:

$$E = E^{\circ} + S \log(a)$$

where: E - the measured voltage;

E° - standard voltage and other standard system voltages;

a - the activity of the ion being measured;

$$S = \frac{2.303RT}{nF}$$

S - the Nernst slope factor and is derived from thermodynamic principles:

R - the universal gas constant (8.314 J/Kmol);

T - the temperature in degrees Kelvin;

F - the Faraday's constant (96,485 C/mol);

n - the Ion charge.

The slope may be positive or negative depending upon the Ion charge (n).

SPECIES	SLOPE (mV/decade)
Monovalent cation	+59.16
Monovalent anion	-59.16
Divalent cation	+29.58
Divalent anion	-29.58

Activity and concentration are related by an "activity coefficient", expressed as:

$$a = \gamma \cdot C$$

where: a - the activity of the Ion being measured;

γ - the activity coefficient;

C - the concentration of the Ion being measured.

In very dilute solutions γ approaches 1 so activity and concentration are the same.

Actual samples that are more concentrated have much smaller activity coefficients ($\gamma < 1$). The addition of an inert background salt to standards and samples stabilizes the activity coefficient so that concentration measurements may be made directly. Some of Hanna's Ionic Strength Adjuster formulations also may optimize pH and complex interferences, in addition to standardizing the ionic strength.

The Nernst equation can be rewritten:

$$E = E^{\circ} + S \log(C)$$

ION SELECTIVE ANALYSIS METHODS

Direct Analysis

This method is a simple procedure for measuring multiple samples. It should only be used in the linear working regions of the sensor. A direct reading instrument such as the [HI5522](#) determines concentration of the unknown by a direct reading after calibrating the instrument with the standards. The instrument is calibrated as described in "ISE CALIBRATION" section, with two or more freshly made standards that are in the measurement range of the unknowns. Ionic strength adjustment is made to samples and standards. Unknowns are measured directly by the instrument.

At lower concentrations, in non-linear regions of the electrode response, multiple calibration points will extend measurements to a practical detection limit. Calibrations must be performed more frequently in these cases.

Incremental Methods

Incremental methods are useful for the measurement of samples whose constituents are variable or concentrated. Incremental techniques can reduce errors from such variables as temperature, viscosity, or pH extremes and will provide indirect analysis of ions for which there is no ISE sensor for a direct measurement. There are four commonly used different incremental methods for sample measurement. They are Known Addition, Known Subtraction, Analyte Addition and Analyte Subtraction. [HI5522](#) allows the analyst to use these techniques as a simple routine procedure, thus eliminating calculations or tables. The method once set up can be used for repetitive measurements on multiple samples.

Known Addition and Known Subtraction

With Known addition, standard is added to a sample being measured. The standard and sample contain the same ion. mV are taken before and after the standard addition. From the change in mV, the sample concentration is determined.

$$C_{SAMP} = \frac{C_{STD} \cdot V_{STD} \cdot (V_{SAMP} + V_{ISA})}{(V_{SAMP} + V_{STD} + V_{ISA}) \cdot 10^{\frac{\Delta E}{S}} \cdot (V_{SAMP} + V_{ISA}) \cdot V_{SAMP}}$$

With Known subtraction, a known standard is added to an ionic sample being measured. The standard reacts with the measured ion in the sample in a known manner, thus removing measured ions from the solution. From the change in mV, the concentration of the sample is determined.

$$C_{SAMP} = \frac{C_{STD} \cdot V_{STD} \cdot f \cdot (V_{SAMP} + V_{ISA})}{(V_{SAMP} + V_{ISA}) - (V_{SAMP} + V_{STD} + V_{ISA}) \cdot 10^{\frac{\Delta E}{S}} \cdot V_{SAMP}}$$

where: C_{SAMP} - the sample concentration; ΔE - the difference of potential from the electrode;
 C_{STD} - the standard concentration; S - the electrode slope, determined in a previous calibration;
 V_{SAMP} - the sample volume; f - the stoichiometric ratio between sample and standard;
 V_{STD} - the standard volume;
 V_{ISA} - ISA volume

Example 1

You have sulfide samples and you are adding Ag^+ . The reaction is:

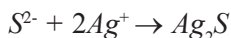

One mole sulfide sample reacts with 2 moles silver standard ($f = 1/2$).

Example

You have sulfide samples and you are adding Pb^{2+} . The reaction is:

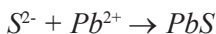

One mole sulfide sample reacts with 1 mole lead standard ($f = 1$).

Analyte Addition and Analyte Subtraction

Analyte Addition and Subtraction are variations of the previous two methods.

With Analyte Addition, sample (analyte) is added to an Ion standard being measured. The standard and sample contain the same ion. mV are taken before and after the sample addition. From the mV the analyte concentration is determined.

$$C_{SAMP} = \frac{C_{STD} \cdot V_{STD}}{(V_{STD} + V_{ISA})} \cdot \frac{(V_{STD} + V_{SAMP} + V_{ISA}) \cdot 10^{\frac{\Delta E}{S}} - (V_{STD} + V_{ISA})}{V_{SAMP}}$$

With Analyte Subtraction, sample (analyte) is added to an ion standard being measured. The analyte reacts with the measured ion in a known manner thus removing measured ions from the solution. From the change in mV the concentration of the analyte is determined.

$$C_{SAMP} = f \cdot \left\{ \frac{(V_{STD} + V_{ISA})}{V_{SAMP}} - \left[1 + \frac{(V_{STD} + V_{ISA})}{V_{SAMP}} \right] \cdot 10^{\frac{\Delta E}{S}} \right\} \cdot \left(\frac{C_{STD} \cdot V_{STD}}{V_{STD} + V_{ISA}} \right)$$

where: C_{SAMP} - the sample concentration; ΔE - the difference of potential from the electrode;
 C_{STD} - the standard concentration; S - the electrode slope, determined in a previous calibration;
 V_{SAMP} - the sample volume;
 V_{STD} - the standard volume; f - the stoichiometric ratio between sample and standard;
 V_{ISA} - ISA volume;

Temperature has an effect on pH. The calibration buffer solutions are affected by temperature changes to a lower degree than normal solutions. During calibration, the instrument will automatically calibrate to the pH value corresponding to the measured or set temperature.

TEMP			pH BUFFERS							
°C	K	°F	1.679	3.000	4.010	6.862	7.010	9.177	10.010	12.454
0	273	32	1.670	3.072	4.007	6.982	7.130	9.459	10.316	13.379
5	278	41	1.670	3.051	4.002	6.949	7.098	9.391	10.245	13.178
10	283	50	1.671	3.033	4.000	6.921	7.070	9.328	10.180	12.985
15	288	59	1.673	3.019	4.001	6.897	7.046	9.273	10.118	12.799
20	293	68	1.675	3.008	4.004	6.878	7.027	9.222	10.062	12.621
25	298	77	1.679	3.000	4.010	6.862	7.010	9.177	10.010	12.450
30	303	86	1.683	2.995	4.017	6.851	6.998	9.137	9.962	12.286
35	308	95	1.688	2.991	4.026	6.842	6.989	9.108	9.919	12.128
40	313	104	1.693	2.990	4.037	6.837	6.983	9.069	9.881	11.978
45	318	113	1.700	2.990	4.049	6.834	6.979	9.040	9.847	11.834
50	323	122	1.707	2.991	4.062	6.834	6.978	9.014	9.817	11.697
55	328	131	1.715	2.993	4.076	6.836	6.979	8.990	9.793	11.566
60	333	140	1.724	2.995	4.091	6.839	6.982	8.969	9.773	11.442
65	338	149	1.734	2.998	4.107	6.844	6.987	8.948	9.757	11.323
70	343	158	1.744	3.000	4.123	6.850	6.993	8.929	9.746	11.211
75	348	167	1.755	3.002	4.139	6.857	7.001	8.910	9.740	11.104
80	353	176	1.767	3.003	4.156	6.865	7.010	8.891	9.738	11.003
85	358	185	1.780	3.002	4.172	6.873	7.019	8.871	9.740	10.908
90	363	194	1.793	3.000	4.187	6.880	7.029	8.851	9.748	10.819
95	368	203	1.807	2.996	4.202	6.888	7.040	8.829	9.759	10.734

During calibration, the instrument will display the pH buffer value at 25 °C.

MEASURE

- Rinse conductivity probe with deionized water and shake off excess water.
- To avoid cross-contamination, rinse probe with a sample of solution to be tested. The measurement solution is that contained within the sleeve.
- Insert probe into the center of the beaker with sample. Position it so it is away from the walls or bottom of the beaker. The vent holes must be covered with solution.
- Tap the probe repeatedly to dislodge any air bubbles that may be trapped inside the sleeve. Allow time for the reading to stabilize and reach thermal equilibrium.
- If you are adjusting the conductivity of the solution, stir the solution, then raise and lower the probe to ensure representative sample is measured within the sleeve of the probe.
- If required, wait for the probe to reach thermal equilibrium with the sample.

PERIODIC MAINTENANCE

Inspect the probe and the cable. The cable used for connection to the instrument must be intact and there must be no points of broken insulation on the cable. Connectors must be perfectly clean and dry. Rinse off any salt deposits with water.

If more cleaning is required, remove the probe sleeve and clean the probe with a cloth or a nonabrasive detergent. Make sure to reinsert the sleeve onto the probe properly and in the right direction. After cleaning the probe, recalibrate the instrument.

The 4 platinum rings are precisely spaced along a glass insulator. Take great care while handling the probe.

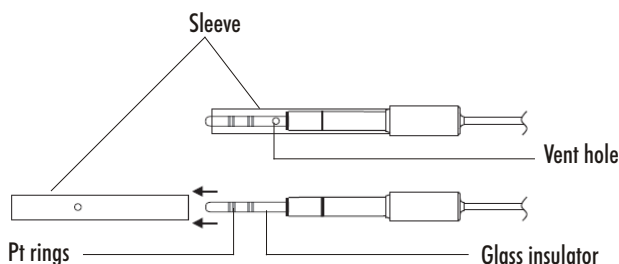

IMPORTANT: After performing any of the cleaning procedures, rinse the electrode thoroughly with distilled water.

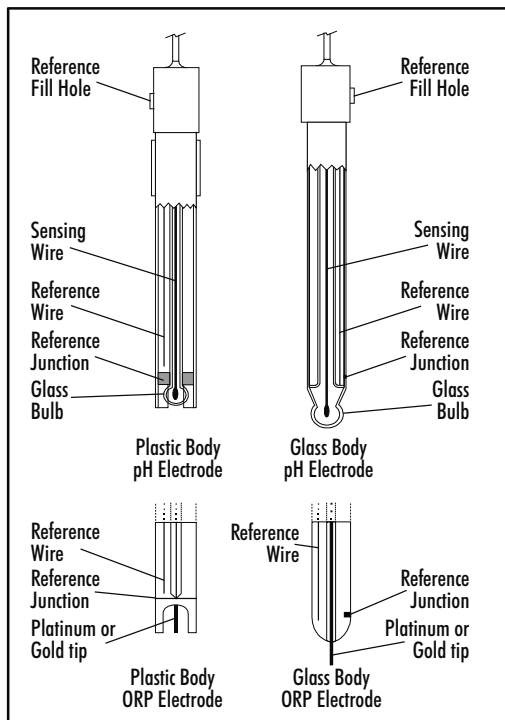

PREPARATION PROCEDURE

Remove the protective cap off the pH electrode.

SALT DEPOSITS MAY BE PRESENT. They will disappear when rinsed with water.

During transport, tiny bubbles of air may form inside the glass bulb, affecting proper functioning of the electrode. These bubbles can be removed by “shaking down” the electrode as you would do with a glass thermometer.

If the bulb and/or junction is dry, soak the electrode in [HI70300](#) or [HI80300](#) Storage Solution for at least one hour.

For refillable electrodes:

If the filling solution (electrolyte) is more than 2.5 cm (1”) below the fill hole, add [HI7082](#) or [HI8082](#) 3.5M KCl Electrolyte Solution for double junction or [HI7071](#) or [HI8071](#) 3.5M KCl + AgCl Electrolyte Solution for single junction electrodes.

Unscrew the fill hole screw during measurements. This will allow electrolyte to flow out of the junction. For Amphenol electrodes if the electrode does not respond to pH changes, the battery may require replacement (if replaceable).

MEASURE

Rinse the pH electrode tip with distilled water. Immerse the sensor tip bottom 4 cm (1½") in the sample and stir gently for a few seconds. For a faster response and to avoid cross-contamination of the samples, rinse the electrode tip with a few drops of the solution to be tested, before taking measurements.

STORAGE PROCEDURE

To minimize clogging and ensure a quick response time, the glass bulb and the junction of the pH electrode should be kept moist and not allowed to dry out.

Replace the solution in the protective cap with a few drops of [HI70300](#) or [HI80300](#) Storage Solution or, in its absence, Filling Solution ([HI7071](#) or [HI8071](#) for single junction and [HI7082](#) or [HI8082](#) for double junction electrodes). Follow the Preparation Procedure before taking measurements.

Note: NEVER STORE THE ELECTRODE IN DISTILLED OR DEIONIZED WATER.

PERIODIC MAINTENANCE

Inspect the electrode and the cable. The cable used for connection to the instrument must be intact and there must be no points of broken insulation on the cable or cracks on the electrode stem or bulb. Connectors must be perfectly clean and dry. If any scratches or cracks are present, replace the electrode. Rinse off any salt deposits with water.

pH PROBE MAINTENANCE

For refillable electrodes:

Refill the reference chamber with fresh electrolyte ([HI7071](#) or [HI8071](#) for single junction or [HI7082](#) or [HI8082](#) for double junction electrodes). Allow the electrode to stand upright for 1 hour. Follow the Storage Procedure above.

pH CLEANING PROCEDURE

- General Soak in Hanna [HI7061](#) or [HI8061](#) General Cleaning Solution for approximately one hour.
- Protein Soak in Hanna [HI7073](#) or [HI8073](#) Protein Cleaning Solution for 15 minutes.
- Inorganic Soak in Hanna [HI7074](#) Inorganic Cleaning Solution for 15 minutes. this solution is good at cleaning a black ceramic junction.
- Oil/grease Rinse with Hanna [HI7077](#) or [HI8077](#) Oil and Fat Cleaning Solution.

IMPORTANT: After performing any of the cleaning procedures, rinse the electrode thoroughly with distilled water, refill the reference chamber with fresh electrolyte (not necessary for gel-filled electrodes) and soak the electrode in [HI70300](#) or [HI80300](#) Storage Solution for at least 1 hour before taking measurements.

SYMPTOMS	PROBLEM	SOLUTION
Slow response/excessive drift.	Dirty pH electrode. Dirty reference junction.	Soak the electrode tip in HI7061 solution for 30 minutes and then rinse the electrode. Soak in HI7074.
Reading fluctuate up and down (noise).	Clogged/dirty junction. Low electrolyte level (refillable electrodes only).	Clean the electrode. Refill with fresh solution (refillable electrodes only).
The LCD displays “----” during measurements (pH, mV, mV Rel or ISE).	Out of range in the appropriate scale.	Verify sensor in solution. Check the electrolyte level and the general state of the pH/ORP or ISE electrode. Recalibrate.
Out of range in the mV scale.	Dry junction.	Soak in HI70300 storage solution for at least one hour. Inspect sensor for damage.
The instrument does not work with the temperature probe.	Out of order temperature probe.	Replace the probe.
The meter fails to calibrate or gives faulty readings.	Broken electrode.	Replace the electrode.
Explicit warnings are displayed during calibration.	Dirty/broken electrode, contaminated buffers.	Follow displayed instructions.
The electrode condition is not displayed after calibration.	Only one-point calibration has been performed.	Perform at least a two-point calibration.

CONDUCTIVITY / RESISTIVITY / TDS / SALINITY CHANNEL

SYMPTOMS	PROBLEM	SOLUTION
The instrument does not override the loading process.	Internal or software error.	Restart the instrument using the power button. If the error persists, contact your vendor.
Reading fluctuates up and down (noise).	Conductivity probe not properly connected.	Check connection. Remove bubbles. Move away from beaker walls and verify top holes are covered by solution.
Display shows "----" during measurements.	Reading out of range.	Recalibrate the meter; Check the sample if is within the measurable range. Verify probe in solution.
The instrument does not measure the temperature from the probe.	The probe temperature sensor is broken. / The temperature source is set as manual.	Replace the probe. / Set the temperature source as automatic and Channel 2.
Meter fails to calibrate or gives faulty readings.	Broken Conductivity probe.	Replace the probe.
Explicit warnings are displayed during calibration.	Dirty / damaged probe, contaminated standards.	Follow displayed instructions.
"Error Detected" pop-up at start up.	Initialization error.	Visualize the error (by pressing Yes key). Contact your vendor if critical error occurs.

The resistance of glass electrodes partially depends on the temperature. The lower the temperature, the higher the resistance. It takes more time for the reading to stabilize if the resistance is higher.

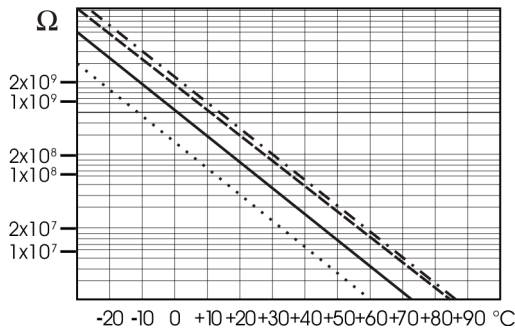

Since the resistance of the pH electrode is in the range of 50 – 200 MΩ, the current across the membrane is in the pico Ampere range. Large currents can disturb the calibration of the electrode for many hours.

The pH electrode's life also depends on the temperature. If constantly used at high temperatures, the electrode life is drastically reduced.

Typical Electrode Life

Ambient Temperature	1 - 3 years
90 °C (194 °F)	Less than 4 months
120 °C (248 °F)	Less than 1 month

Alkaline Error

High concentrations of sodium ions interfere with readings in alkaline solutions. The pH at which the interference starts to be significant depends upon the composition of the glass. This interference is called alkaline error and causes the pH to be underestimated.

pH BUFFER SOLUTIONS

HI6016	pH 1.679 Buffer Solution, 500 mL bottle
HI6003	pH 3.000 Buffer Solution, 500 mL bottle
HI8004L	pH 4.01 Buffer Solution in FDA approved bottle, 500 mL
HI6004	pH 4.010 Buffer Solution, 500 mL bottle
HI8006L	pH 6.86 Buffer Solution in FDA approved bottle, 500 mL
HI6068	pH 6.862 Buffer Solution, 500 mL bottle
HI8007L	pH 7.01 Buffer Solution in FDA approved bottle, 500 mL
HI6007	pH 7.010 Buffer Solution, 500 mL bottle
HI6091	pH 9.177 Buffer Solution, 500 mL bottle
HI8009L	pH 9.18 Buffer Solution in FDA approved bottle, 500 mL
HI8010L	pH 10.01 Buffer Solution in FDA approved bottle, 500 mL
HI6010	pH 10.010 Buffer Solution, 500 mL bottle
HI6124	pH 12.450 Buffer Solution, 500 mL bottle

CONDUCTIVITY STANDARD SOLUTIONS

HI7033M	84 $\mu\text{S}/\text{cm}$, 230 mL bottle
HI7033L	84 $\mu\text{S}/\text{cm}$, 500 mL bottle
HI8033L	84 $\mu\text{S}/\text{cm}$, 500 mL FDA approved bottle
HI70031P	1413 $\mu\text{S}/\text{cm}$, 20 mL sachets (25 pcs.)
HI7031M	1413 $\mu\text{S}/\text{cm}$, 230 mL bottle
HI7031L	1413 $\mu\text{S}/\text{cm}$, 500 mL bottle
HI8031L	1413 $\mu\text{S}/\text{cm}$, 500 mL FDA approved bottle
HI70039P	5000 $\mu\text{S}/\text{cm}$, 20 mL sachets (25 pcs.)
HI7039M	5000 $\mu\text{S}/\text{cm}$, 230 mL bottle
HI7039L	5000 $\mu\text{S}/\text{cm}$, 500 mL bottle
HI8039L	5000 $\mu\text{S}/\text{cm}$, 500 mL FDA approved bottle
HI70030P	12880 $\mu\text{S}/\text{cm}$, 20 mL sachets (25 pcs.)
HI7030M	12880 $\mu\text{S}/\text{cm}$, 230 mL bottle
HI7030L	12880 $\mu\text{S}/\text{cm}$, 500 mL FDA approved bottle
HI7034M	80000 $\mu\text{S}/\text{cm}$, 230 mL bottle
HI7034L	80000 $\mu\text{S}/\text{cm}$, 500 mL bottle
HI8034L	80000 $\mu\text{S}/\text{cm}$, 500 mL FDA approved bottle

HI7035M	111800 $\mu\text{S}/\text{cm}$, 230 mL bottle
HI7035L	111800 $\mu\text{S}/\text{cm}$, 500 mL bottle
HI8035L	111800 $\mu\text{S}/\text{cm}$, 500 mL FDA approved bottle
HI7037L	100% NaCl sea water standard solution, 500 mL

ELECTRODE STORAGE SOLUTIONS (pH/ORP)

HI70300L	Storage Solution, 500 mL bottle
HI80300L	Storage Solution in FDA approved bottle, 500 mL

ELECTRODE AND PROBE CLEANING SOLUTIONS

HI70000P	Electrode Rinse Sachets, 20 mL, 25 pcs
HI7061	General Purpose Solution, 500 mL bottle
HI7073L	Protein Cleaning Solution, 500 mL bottle
HI7074L	Inorganic Cleaning Solution, 500 mL bottle
HI7077L	Oil & Fat Cleaning Solution, 500 mL bottle
HI8061L	General Purpose Solution in FDA approved bottle, 500 mL
HI8073L	Protein Cleaning Solution in FDA approved bottle, 500 mL
HI8077L	Oil & Fat Cleaning Solution in FDA approved bottle, 500 mL

ELECTRODE REFILL ELECTROLYTE SOLUTIONS

HI7071	3.5M KCl + AgCl Electrolyte, 4x30 mL, for single junction electrodes
HI7072	1M KNO_3 Electrolyte, 4x30 mL
HI7082	3.5M KCl Electrolyte, 4x30 mL, for double junction electrodes
HI8071	3.5M KCl + AgCl Electrolyte in FDA approved bottle, 4x30 mL, for single junction electrodes
HI8072	1M KNO_3 Electrolyte in FDA approved bottle, 4x30 mL
HI8082	3.5M KCl Electrolyte in FDA approved bottle, 4x30 mL, for double junction electrodes
HI8093	1M KCl + AgCl Electrolyte in FDA approved bottle, 4x30 mL

ORP PRETREATMENT SOLUTIONS

HI7020L	Test Solution 200-275 mV, 500 mL bottle
HI7021	Test Solution 240 mV, 500 mL bottle
HI7022L	Test Solution 470 mV, 500 mL bottle
HI7091L	Reducing Pretreatment Solution, 500 mL
HI7092L	Oxidizing Pretreatment Solution, 500 mL

pH ELECTRODES

All electrodes part numbers ending in B are supplied with a BNC connector and 1 m (3.3') cable, as shown below:

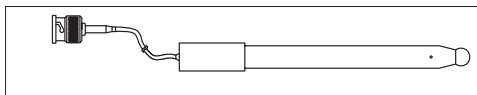

HI1043B

Glass body, double junction, refillable, combination pH electrode.

Use: strong acid/alkali.

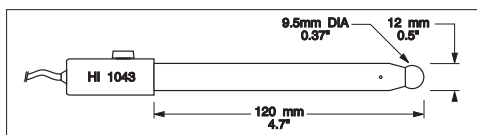

HI1053B

Glass body, double junction, triple ceramic, conic shape, refillable, combination pH electrode.

Use: emulsions.

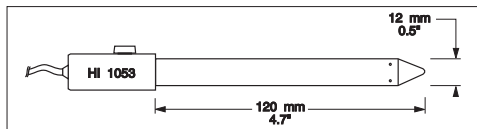

HI1083B

Glass body, single junction, micro, Viscolene, non refillable, combination pH electrode.

Use: biotechnology, micro titration.

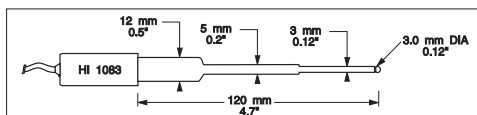

HI1131B

Glass body, double junction, refillable, combination pH electrode.

Use: general purpose.

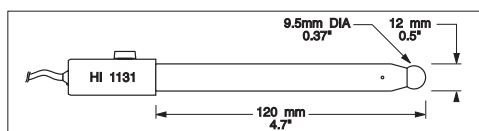

HI1330B

Glass body, semi-micro, single junction, refillable, combination pH electrode.

Use: laboratory, vials.

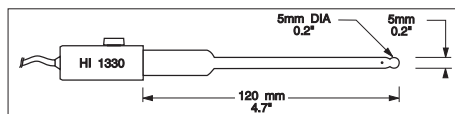
**HI1331B**

Glass body, semi-micro, single junction, refillable, combination pH electrode.

Use: flasks.

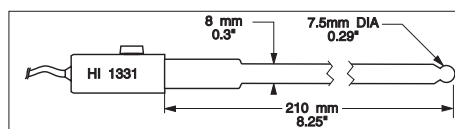
**HI1230B**

Plastic body, double junction, gel filled, combination pH electrode.

Use: general, field.

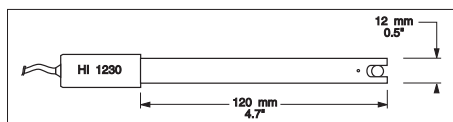
**HI2031B**

Glass body, semi-micro, single junction, conical, refillable, combination pH electrode.

Use: semi-solid products.

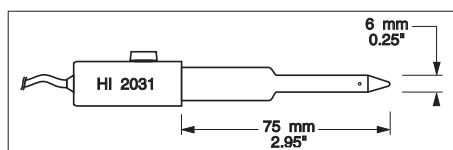
**HI1332B**

Plastic body, double junction, refillable, combination pH electrode.

Use: general purpose.

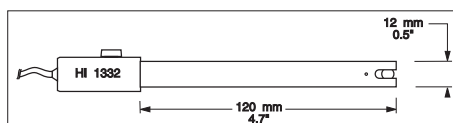

HI1413B

Glass body, single junction, flat tip, Viscolene, non-refillable, combination pH electrode.

Use: surface measurement.

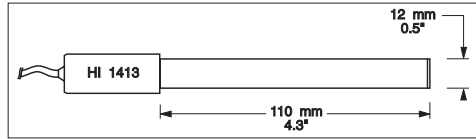
**FC100B**

Plastic body, double junction, refillable, combination pH electrode.

Use: general purpose for food industry.

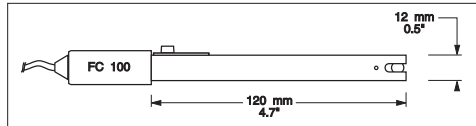
**FC200B**

Plastic body, open junction, conical, Viscolene, non refillable, combination pH electrode.

Use: meat & cheese.

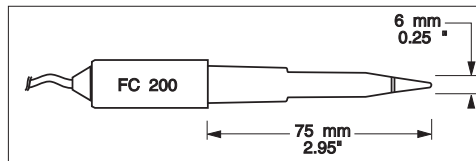
**FC210B**

Glass body, double junction, conical, Viscolene, non refillable, combination pH electrode.

Use: milk, yogurt.

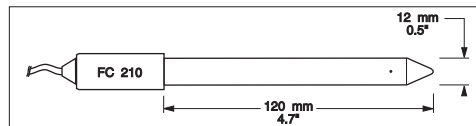

FC220B

Glass body, triple ceramic, single junction, refillable, combination pH electrode.

Use: food processing.

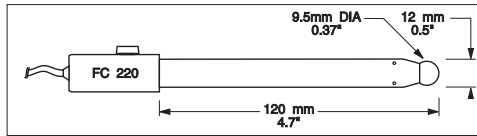
**FC911B**

Plastic body, double junction, refillable with built-in amplifier, combination pH electrode.

Use: very high humidity.

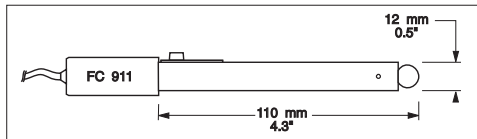
**ORP ELECTRODES****HI3131B**

Glass body, refillable, combination platinum ORP electrode.

Use: titration.

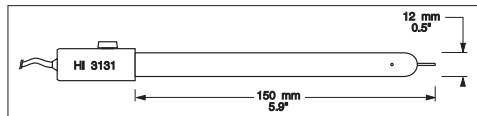
**HI3230B**

Plastic body, gel filled, combination platinum ORP electrode.

Use: general purpose.

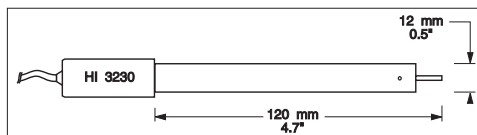

HI4430B

Plastic body, gel filled, combination gold **ORP** electrode.

Use: general purpose.

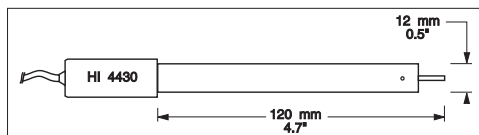

Consult the Hanna General Catalog for more electrodes with screw-type or BNC connectors.

EXTENSION CABLE FOR SCREW-TYPE ELECTRODES (SCREW TO BNC ADAPTER)

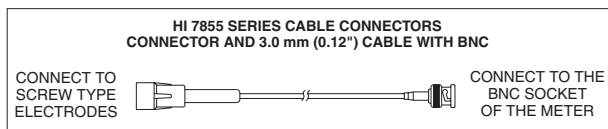

HI7855/1 Extension cable 1 m (3.3') long

HI7855/3 Extension cable 3 m (9.9') long

OTHER ACCESSORIES

HI710005/8	Voltage adapter from 120 Vac / 12 Vdc 800 mA (USA plug)
HI710006/8	Voltage adapter from 230 Vac / 12 Vdc 800 mA (European plug)
HI76404W	Electrode holder
HI8427	pH and ORP electrode simulator with 1 m (3.3') coaxial cable ending in female BNC connectors
HI931001	pH and ORP electrode simulator with LCD and 1 m (3.3') coaxial cable ending in female BNC connectors
HI76312	Platinum 4-ring conductivity/TDS probe with temperature sensor and 1 m (3.3') cable
HI7662-W	Temperature probe with 1 m (3.3') cable
HI92000	Windows® compatible software
HI920013	USB cable

Recommendations for Users

Before using Hanna products, make sure that they are entirely suitable for your specific application and for the environment in which they are used. Operation of these instruments may cause unacceptable interferences to other electronic equipment. Take all necessary steps to correct such interferences.

During operation, ESD wrist straps should be worn to avoid possible damage to the electrode by electrostatic discharges.

Any variation introduced by the user to the supplied equipment may degrade the instruments' EMC performance.

To avoid electrical shock, do not use these instruments when voltages at the measurement surface exceed 24 Vac or 60 Vdc.

To avoid damage or burns, do not perform any measurement in microwave ovens.

Warranty

The [HI5521](#) & [HI5522](#) are warranted for two years against defects in workmanship and materials when used for their intended purpose and maintained according to instructions. Electrodes and probes are warranted for six months. This warranty is limited to repair or replacement free of charge.

Damage due to accidents, misuse, tampering or lack of prescribed maintenance is not covered.

If service is required, contact the dealer from whom you purchased the instrument. If under warranty, report the model number, date of purchase, serial number and the nature of the problem. If the repair is not covered by the warranty, you will be notified of the charges incurred. If the instrument is to be returned to Hanna Instruments, first obtain a Returned Goods Authorization (RGA) number from the Technical Service department and then send it with shipping costs prepaid. When shipping any instrument, make sure it is properly packed for complete protection.

Hanna Instruments reserves the right to modify the design, construction or appearance of its products without advance notice.

World Headquarters

Hanna Instruments Inc.
Highland Industrial Park
584 Park East Drive
Woonsocket, RI 02895 USA
www.hannainst.com

Local Office

Hanna Instruments USA
270 George Washington Highway
Smithfield, RI 02917
Phone: 800.426.6287
Fax: 401.765.7575
e-mail: tech@hannainst.com

Local Sales and Customer Service Office



MAN5522 05/16

Printed in ROMANIA