



**KERN & Sohn GmbH**

Ziegelei 1  
D-72336 Balingen  
E-Mail: [info@kern-sohn.com](mailto:info@kern-sohn.com)

Phone: +49-[0]7433-9933-0  
Fax: +49-[0]7433-9933-149  
Internet: [www.kern-sohn.com](http://www.kern-sohn.com)

# Operating and Installation Instructions - Display Unit

## KERN KXS-TM / KXG-TM

Type KXS-TNM / KXG-TNM

Version 3.1  
2018-11  
GB

Importør:  
Impex Produkter AS  
Gamle Drammensvei 107  
1363 Høvik  
[www.impex.no](http://www.impex.no)  
[info@impex.no](mailto:info@impex.no)  
Tel.: 22 32 77 20



KXS / KXG-TM-BA\_IA-e-1831



# KERN KXS-TM / KXG-TM

Version 3.1 2018-11

## Operating and installation instructions Display unit

### Contents

<b>1</b>	<b>Technical data</b> .....	<b>4</b>
1.1	Dimensions .....	5
1.2	Connections.....	6
<b>2</b>	<b>Declaration of conformity</b> .....	<b>7</b>
<b>3</b>	<b>Appliance overview</b> .....	<b>7</b>
3.1	Keyboard overview .....	8
3.2	Overview of display .....	10
3.3	Overview display icons .....	11
<b>4</b>	<b>Basic Information (General)</b> .....	<b>12</b>
4.1	Proper use .....	12
4.2	Improper Use .....	12
4.3	Warranty .....	12
4.4	Monitoring of Test Resources .....	13
<b>5</b>	<b>Basic Safety Precautions</b> .....	<b>13</b>
5.1	Pay attention to the instructions in the Operation Manual.....	13
5.2	Personnel training.....	13
<b>6</b>	<b>Transport and storage</b> .....	<b>13</b>
6.1	Testing upon acceptance .....	13
6.2	Packaging / return transport .....	13
<b>7</b>	<b>Unpacking and placing</b> .....	<b>14</b>
7.1	Installation Site, Location of Use .....	14
7.2	Unpacking.....	14
7.3	Scope of delivery / serial accessories .....	14
7.4	Transport Securing .....	15
7.5	Placing.....	16
7.6	Rechargeable battery operation (Factory option).....	16
7.7	Adjustment.....	16
7.7.1	Verified weighing systems:.....	16
7.7.2	Not verifiable weighing systems .....	18
7.8	Linearisation .....	19
7.9	Verification.....	21

<b>8</b>	<b>Basic Operation .....</b>	<b>23</b>
8.1	Start-up .....	23
8.2	Switching Off .....	23
8.3	Zeroing .....	23
8.4	Simple weighing .....	23
8.5	Switch-over weighing unit (only not verifiable weighing systems) .....	24
8.6	Weighing with tare .....	25
8.6.1	Taring.....	25
8.6.2	Numerical input of tare (PRE-TARE).....	25
8.7	Display gross / net.....	26
<b>9</b>	<b>General functions .....</b>	<b>27</b>
9.1	Automatic shutdown function .....	27
9.2	Display background illumination.....	28
<b>10</b>	<b>Operation Modes.....</b>	<b>29</b>
10.1	Parts counting.....	29
10.2	Manual totalizing.....	31
10.3	Automatic adding-up.....	34
10.4	Data-Hold functions .....	35
10.4.1	Animal weighing function .....	36
10.5	Weighing with tolerance range .....	38
10.5.1	Tolerance check for target weight.....	39
10.5.2	Tolerance check for target quantity.....	42
<b>11</b>	<b>Menu .....</b>	<b>45</b>
11.1	Overview non-verified weighing systems (Adjustment switch in position <Adj>, see chap. 7.9) 46	
11.2	Overview verified weighing systems (Adjustment switch in position <Lock>, see chap. 7.9)..	50
<b>12</b>	<b>RS 485 – pin allocation.....</b>	<b>51</b>
<b>13</b>	<b>RS 232C .....</b>	<b>52</b>
13.1	Pin allocation .....	52
13.2	Printer operation / sample logs.....	53
13.3	Output log (continuous output) .....	54
13.4	Remote control instructions .....	54
13.5	Command Mode .....	55
13.5.1	Command Format A.....	55
13.5.2	Command Format B.....	55
13.5.3	Command Format C.....	56
13.5.4	Command Format D.....	57
<b>14</b>	<b>Bluetooth (Factory option).....</b>	<b>58</b>
<b>15</b>	<b>Installing display unit / weighing bridge.....</b>	<b>62</b>
15.1	Technical data .....	62
15.2	Weighing system design.....	62
15.3	How to connect the platform.....	63
15.4	Configure display unit.....	64
15.4.1	Configuration example single range scale.....	65
15.4.2	Configuration example dual range scale.....	66

## 1 Technical data

KERN	KXS-TM	KXG-TM
Product No / Type	KXS-TNM	KXG-TNM
Display	6-digit	
Resolution verifiable	Single (Max.) 10,000 e	
	Dual (Max.) 5,000 e	
Resolution non-verifiable	30,000 d	
Verification class	III	
Weighing ranges	2	
Weighing units	g, kg	
Divisions	1,2,5,...10, n	
Display	LCD 55 mm digits with back lighting	
DMS weighing cells	Max. 8 x 350 $\Omega$	
Electric Supply	Input voltage 110 - 230 V AC	
	Built-in power supply unit	
Rechargeable battery optional Factory option	6 V, 4.5 Ah	
	Operating time (backlight on) 40 h Operating time (backlight off) 80 h	
	Loading time 12 h	
Admissible ambient temperature	-10°C – 40°C	
Humidity of air	< 85 % relative (not condensing)	
Net weight	2,500 g	2,000 g
Housing material	Stainless steel	Synthetic material
Dimensions Width x Depth x Height, (mm)	232 x 170 x 80	
Interfaces Factory option	RS232: KXS-A04	
	RS485: KXS-A01	
	Bluetooth: KXS-A02	

1.1 Dimensions

➤ KXS-TNM

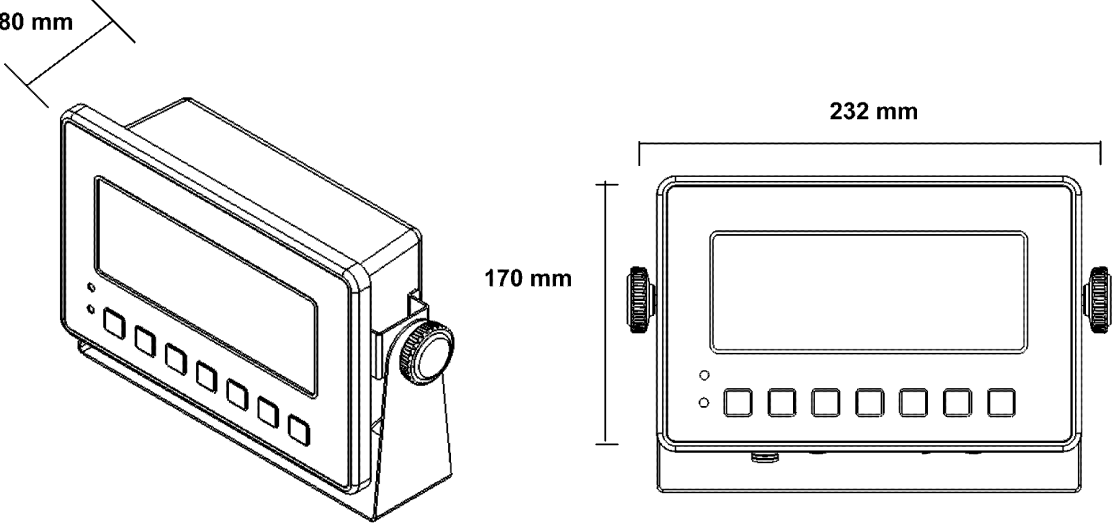

➤ KXG-TNM

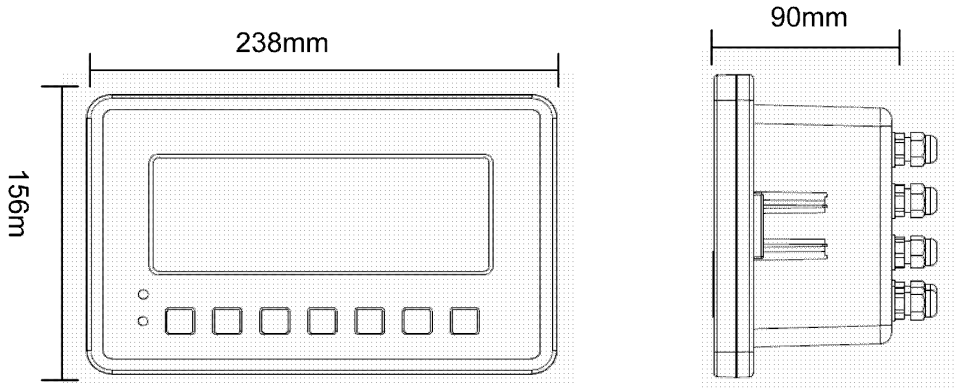

## 1.2 Connections

### ➤ KXS-TNM

#### Standard

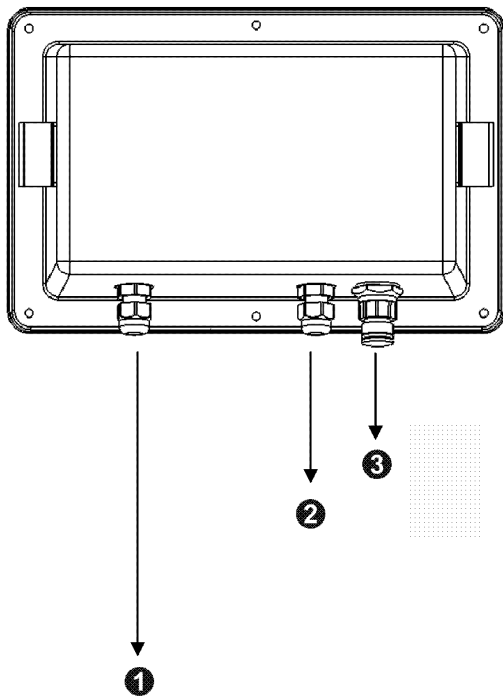

1	Electric Supply
2	Load cell
3	RS232

#### Factory option

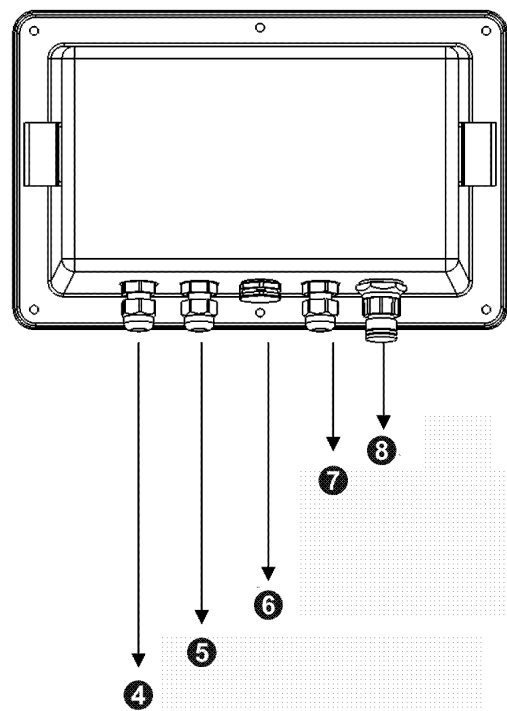

4	Electric Supply
5	Foot switch or RS 485
6	Pressure compensation membrane
7	RS232
8	Load cell

### ➤ KXG-TNM

#### Standard

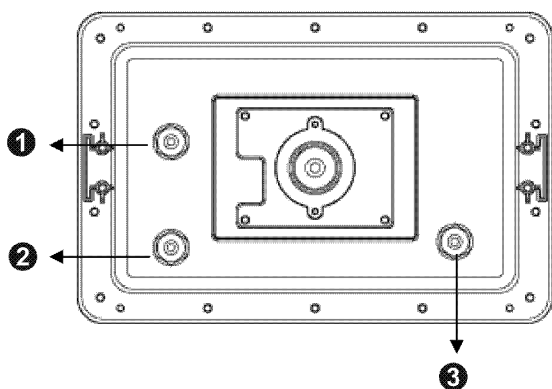

1	RS232
2	Load cell
3	Electric Supply

#### Factory option

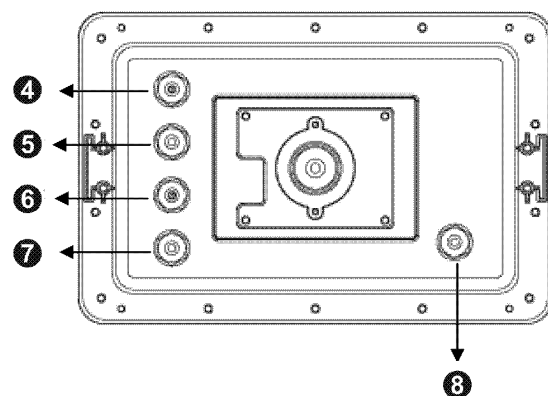

4	Foot switch
5	RS232
6	RS485
7	Load cell
8	Electric Supply

## 2 Declaration of conformity

The current EC/EU Conformity declaration can be found online in:

[www.kern-sohn.com/ce](http://www.kern-sohn.com/ce)

**i** For verified weighing scales (= weighing scales assessed for conformity) a declaration of conformity is included in the scope of delivery.

## 3 Appliance overview



Exemplified in image KXS-TNM



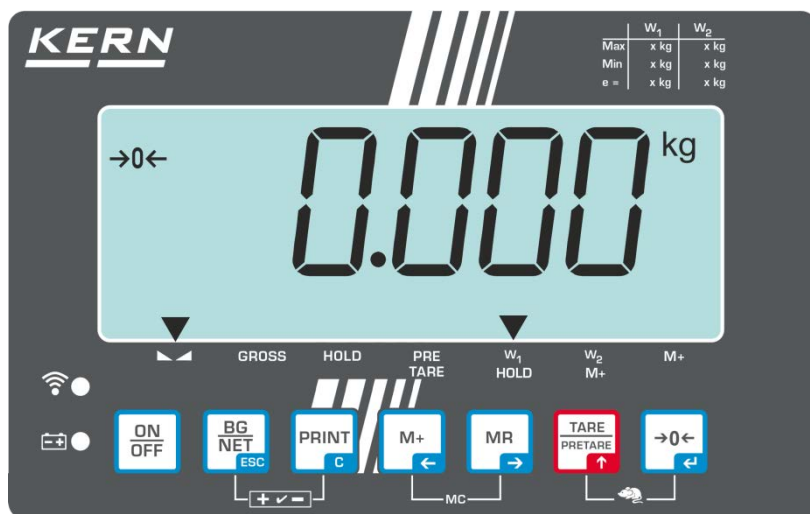

1. Weight display
2. Wireless
3. Status of rechargeable battery
4. Locking screw
5. Keyboard
6. Support base/Wall fixture

### 3.1 Keyboard overview



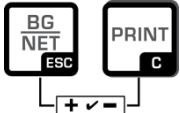
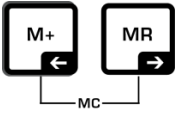

Button	Function	Designation
	<ul style="list-style-type: none"> <li>Turn on/off</li> </ul>	<b>ON/OFF button</b>
 Navigation button ←	<ul style="list-style-type: none"> <li>Zeroing</li> <li>Confirm entry</li> </ul>	<b>ZERO key</b>
 Navigation button ↑	<ul style="list-style-type: none"> <li>Taring</li> <li>At numeric input increase flashing digit</li> <li>Scroll forward in menu</li> </ul>	<b>TARE button</b>
 Navigation button →	<ul style="list-style-type: none"> <li>Display sum total</li> <li>Digit selection to the right</li> </ul>	<b>MR key</b>
 Navigation button ←	<ul style="list-style-type: none"> <li>Weight value in summation memory Add</li> <li>Digit selection to the left</li> </ul>	<b>M+ button</b>
 C	<ul style="list-style-type: none"> <li>Calculate weighing data via interface</li> <li>Delete</li> </ul>	<b>PRINT button</b>

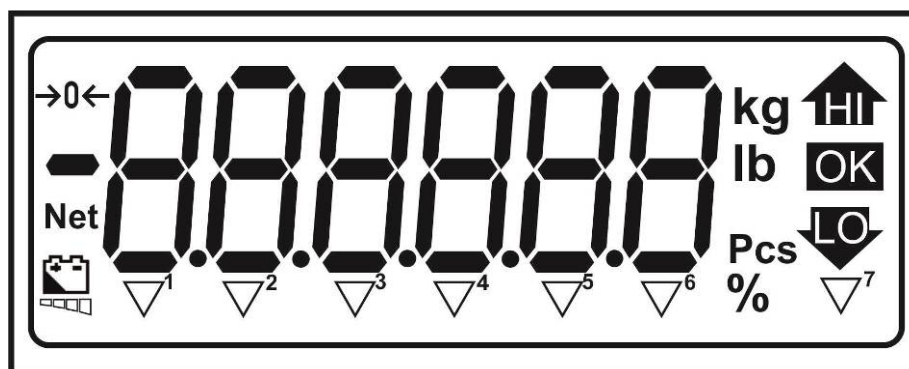

 <p>ESC</p>	<ul style="list-style-type: none"> <li>• Switch over gross weight ↔ net weight</li> <li>• Switch-over weighing unit</li> <li>• Back to menu/weighing mode</li> </ul>	<p><b>BG/ NET key</b></p>
	<ul style="list-style-type: none"> <li>• Call up mean value function</li> </ul>	
	<ul style="list-style-type: none"> <li>• Call up weighing with tolerance range</li> </ul>	
	<ul style="list-style-type: none"> <li>• Delete total added memory</li> </ul>	
	<ul style="list-style-type: none"> <li>• To show an additional decimal place, press and hold the <b>M+ key</b> for approx. three seconds. This decimal place will return to hidden when the key is released.</li> </ul>	

### 3.2 Overview of display



















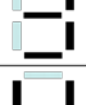
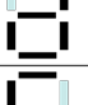



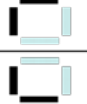



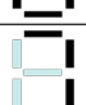
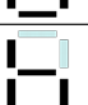
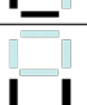



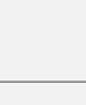

<b>HI / OK / LO</b>	Indicators for weighing with tolerance range
<b>Kg</b>	Current selected unit of weight „kilograms“
<b>Lb</b>	Current selected unit of weight „pound“
<b>Pcs</b>	Parts counting
<b>%</b>	Percent weighing
<b>→0←</b>	Zero indicator
<b>Net</b>	The displayed weighing value is a net weighing value
	Status of rechargeable battery

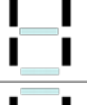
#### Indicator [▼] next to symbol displays:

	▼ <sup>1</sup>	that the weight value is stable
<b>GROSS</b>	▼ <sup>2</sup>	that the displayed weighing value is a gross weight value
<b>HOLD</b>	▼ <sup>3</sup>	that the indicated weight value is held in the display, until it is deleted.
<b>PRE-TARE</b>	▼ <sup>4</sup>	that a PRE-TARE value is stored
<b>W1</b>	▼ <sup>5</sup>	that weighing range 1 is enabled
<b>W2</b>	▼ <sup>6</sup>	that weighing range 2 is enabled
<b>M+</b>	▼ <sup>7</sup>	that data are stored in a summation memory

### 3.3 Overview display icons

0		A		N	
1		B		O	
2		C		P	
3		D		Q	
4		E		R	
5		F		S	
6		G		T	
7		H		U	
8		I		V	
9		J		W	
		K		X	
		L		Y	
		M		Z	

## 4 Basic Information (General)

### 4.1 Proper use

The display unit acquired by you is used in combination with a weighing plate and serves to determine the weighing value of material to be weighed. It is intended to be used as a “non-automatic weighing system”, i.e. the material to be weighed is manually and carefully placed in the center of the weighing plate. As soon as a stable weighing value is reached the weighing value can be read.

### 4.2 Improper Use

Do not use display unit for dynamic weighing. In the event that small quantities are removed or added to the material to be weighed, incorrect weighing results can be displayed due to the “stability compensation“ in the display unit. (Example: Slowly draining fluids from a container on the balance.)

Do not leave permanent load on the weighing pan. This may damage the measuring system.

Impacts and overloading exceeding the stated maximum load (max) of the weighing plate, minus a possibly existing tare load, must be strictly avoided. Both, the weighing plate and the display unit may be damaged during this process.

Never operate display unit in explosive environment. The serial version is not explosion protected.

Changes to the display unit's design are not permitted. This may lead to incorrect weighing results, safety-related faults and destruction of the display unit.

The display unit may only be operated in accordance with the described default settings. Other areas of use must be released by KERN in writing.

### 4.3 Warranty

Warranty claims shall be voided in case

- Our conditions in the operation manual are ignored
- The appliance is used outside the described uses
- The appliance is modified or opened
- Mechanical damage or damage by media, liquids, natural wear and tear
- The appliance is improperly set up or incorrectly electrically connected
- The measuring system is overloaded

#### 4.4 Monitoring of Test Resources

In the framework of quality assurance the measuring-related properties of the display unit and, if applicable, the testing weight, must be checked regularly. The responsible user must define a suitable interval as well as type and scope of this test. Information is available on KERN's home page ([www.kern-sohn.com](http://www.kern-sohn.com)) with regard to the monitoring of display units' test substances and the test weights required for this. In KERN's accredited DKD calibration laboratory test weights and display units may be calibrated (return to the national standard) fast and at moderate cost.

### 5 Basic Safety Precautions

#### 5.1 Pay attention to the instructions in the Operation Manual



- ⇒ Carefully read this operation manual before setup and commissioning, even if you are already familiar with KERN balances.
- ⇒ All language versions contain a non-binding translation. The original German is binding.

#### 5.2 Personnel training

The appliance may only be operated and maintained by trained personnel.

### 6 Transport and storage

#### 6.1 Testing upon acceptance

When receiving the appliance, please check packaging immediately, and the appliance itself when unpacking for possible visible damage.

#### 6.2 Packaging / return transport



- ⇒ Keep all parts of the original packaging for a possibly required return.
- ⇒ Only use original packaging for returning.
- ⇒ Prior to dispatch disconnect all cables and remove loose/mobile parts.
- ⇒ Reattach possibly supplied transport securing devices.
- ⇒ Secure all parts such as the glass wind screen, the weighing platform, power unit etc. against shifting and damage.

## 7 Unpacking and placing

### 7.1 Installation Site, Location of Use

The display units are designed in a way that reliable weighing results are achieved in common conditions of use.

Precise and fast work is achieved by selecting the right place for your display unit and your weighing plate.

**On the installation site observe the following:**

- Place the weighing platform on a firm, level surface;
- Avoid extreme heat as well as temperature fluctuation caused by installing next to a radiator or in the direct sunlight;
- Protect the display unit and the weighing plate against direct draft from open windows or doors.
- Avoid jarring during weighing;
- Protect the display unit and the weighing plate against high humidity, vapours and dust.
- Do not expose the display unit to extreme dampness for longer periods of time. Non-permitted condensation (condensation of air humidity on the appliance) may occur if a cold appliance is taken to a considerably warmer environment. In this case, acclimatize the disconnected appliance for ca. 2 hours at room temperature.
- Avoid static charge of goods to be weighed or weighing container.

Major display deviations (incorrect weighing results) may be experienced should electromagnetic fields (e.g. due to mobile phones or radio equipment), static electricity accumulations or instable power supply occur. Change location or remove source of interference.

### 7.2 Unpacking

Carefully remove the display unit from packaging, remove plastic cover and place it in the designated work area.

and place it in the designated work area.

### 7.3 Scope of delivery / serial accessories

- Display Unit
- Support base incl. wall bracket
- Operating manual

## 7.4 Transport Securing

Please note: if the display unit is used together with platform with transportation lock, this transportation lock must be released prior to use.

Remove the transportation safety device at the four marked positions:

**Version 1:**



Transport Securing



**Version 2:**



## 7.5 Placing

Mount the display unit in a way that facilitates operation and where it is easy to see.

- i** In order to raise the display, the display unit can be mounted on an optional stand.

## 7.6 Rechargeable battery operation (Factory option)

Charge the internal rechargeable battery for at least 12 hours before initial use. The battery symbol indicates the current charge level of the batteries.

A flashing icon  indicates that the rechargeable battery is getting weak. The weighing scale will remain ready for operation for a few more hours before switching off in order to save battery. Recharge the battery completely before your next restart.

## 7.7 Adjustment

As the acceleration value due to gravity is not the same at every location on earth, each display unit with connected weighing plate must be coordinated - in compliance with the underlying physical weighing principle - to the existing acceleration due to gravity at its place of location (only if the weighing system has not already been adjusted to the location in the factory). This adjustment process must be carried out for the first commissioning, after each change of location as well as in case of fluctuating environment temperature. To receive accurate measuring values it is also recommended to adjust the display unit periodically in weighing operation.

- |          |  |
|----------|--|
| <b>i</b> | <ul style="list-style-type: none"><li>• Prepare the required adjustment weight. The adjustment weight to be used depends on the capacity of the weighing system. Carry out adjustment as near as possible to the weighing system's maximum weight. Info about test weights can be found on the Internet at: <a href="http://www.kern-sohn.com">http://www.kern-sohn.com</a>.</li><li>• Observe stable environmental conditions. Stabilisation requires a certain warm-up time.</li></ul> |
|----------|--|

### 7.7.1 Verified weighing systems:

- |          |  |
|----------|--|
| <b>i</b> | <ul style="list-style-type: none"><li>• In verified weighing systems menu item &lt;P3CAL&gt; will be locked. To undo the lock, you have to break the seal and open the casing. Turn adjustment switch <b>SWA1</b> on the printed circuit board to position "<b>ADJ</b>" (See chap. 7.9).</li></ul> |
|----------|--|



⇒ Invoke menu item <P3CAL → CAL> (see chap. 11.1)





- ⇒ To confirm, press  and the current setting will be shown.  
 noLin = Adjustment  
 LineAr = Linearisation



- ⇒ For adjustment press  to select setting < noLin> and confirm by .



- ⇒ Ensure that there are no objects on the weighing pan.  
 Wait for stability display, then press .  
 The currently set adjustment weight will be displayed.



- ⇒ Either apply the displayed adjustment weight or make changes with the help of the navigation keys (see chap. 3.1). Confirm by , „LoAd“ will be shown.

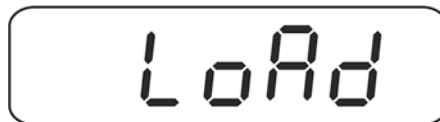

- ⇒ Carefully place adjustment weight in the centre of the weighing plate.  
 Wait for stability display, then press .



- ⇒ After the adjustment the balance will carry out a self-test. Remove adjustment weight **during** selftest, balance will return into weighing mode automatically.



### 7.7.2 Not verifiable weighing systems

⇒ For invoking menu item <P6ZCL> see chap. 11.1.

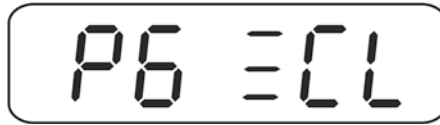

⇒ Ensure that there are no objects on the weighing pan before pressing



⇒ Wait for stability display, then press .  
The currently set adjustment weight will be displayed.



⇒ Either apply the displayed adjustment weight or make changes with the help of the navigation keys (See chap.3.1). Confirm by „LoAd“ will be shown.



⇒ Carefully place adjustment weight in the centre of the weighing plate.

Wait for stability display, then press



⇒ After the adjustment the balance will carry out a self-test. Remove adjustment weight **during** selftest, balance will return into weighing mode automatically.



## 7.8 Linearisation

Linearity shows the greatest deviation of a weight display on the scale to the value of the respective test weight according to plus and minus over the entire weighing range. If linearity deviation is discovered during a monitoring of test resources, you can improve this by means of linearization.

**i**



- In balances with a resolution of > 15 000 dividing steps carrying out a linearisation is recommended.
- Carrying out linearization is restricted to specialist staff possessing well acquainted with the workings of weighing scales.
- The test weights to be used must be adapted to the weighing scale's specifications; see chapter "Monitoring of test equipment".
- Observe stable environmental conditions. Stabilisation requires a certain warm-up time.
- After successful linearisation you will have to carry out calibration; see chapter "Monitoring of test equipment".
- In verified weighing systems menu item <P3CAL> will be locked. To undo the lock, you have to break the seal and open the casing. Turn adjustment switch **SWA1** on the printed circuit board to position "**ADJ**" (See chap. 7.9).

⇒ Invoke menu item <P3CAL → CAL> (see chap. 11.1)

A rectangular digital display with rounded corners showing the text "CAL" in a large, black, monospace font.

⇒ To confirm, press  and the current setting will be shown.  
noLin = Adjustment  
LineAr = Linearisation

A rectangular digital display with rounded corners showing the text "LineAr" in a large, black, monospace font.

⇒ For linearization press  to select setting < LinEr>, to confirm, press .





⇒ Ensure that there are no objects on the weighing pan.

Wait for stability display, then press .



⇒ When “Ld 1” is displayed, put the first adjustment weight (1/3 max) carefully in the centre of the weighing platform. Wait for stability display, then press .



⇒ When “Ld 2” is displayed, put the second adjustment weight (2/3 max) carefully in the centre of the weighing platform. Wait for stability display, then press  .



⇒ When “Ld 3” is displayed, put the third adjustment weight (max) carefully in the centre of the weighing platform. Wait for stability display, then press . After the adjustment the balance will carry out a self-test.



⇒ Remove adjustment weight **during** selftest, balance will return into weighing mode automatically.



## 7.9 Verification

General introduction:

According to EU directive 2009/23/EC balances must be officially verified if they are used as follows (legally controlled area):

- a) For commercial transactions if the price of goods is determined by weighing.
- b) For the production of medicines in pharmacies as well as for analyses in the medical and pharmaceutical laboratory.
- c) For official purpose.
- d) For manufacturing final packages.

In cases of doubt, please contact your local trade in standard.

### Verification notes:

An EU type approval exists for the appliance described in its technical data as verifiable. If the appliance is used where obligation to verify exists as described above, it must be verified and re-verified at regular intervals.

Re-verification of an appliance is carried out according to the respective national regulations. Normally the validity for verification in Germany is e.g. 2 years.

The legal regulation of the country where the balance is used must be observed!



### Verification of the device is invalid without the seals.

The seal marks / verification wire attached on verified appliances point out that the appliance may only be opened and serviced by trained and authorised specialist staff. If the sealing (paper seal/ verification wire) is damaged, the verification validity expires. Please observe all national laws and legal regulations. In Germany a re-verification will be necessary.

### Sealing:

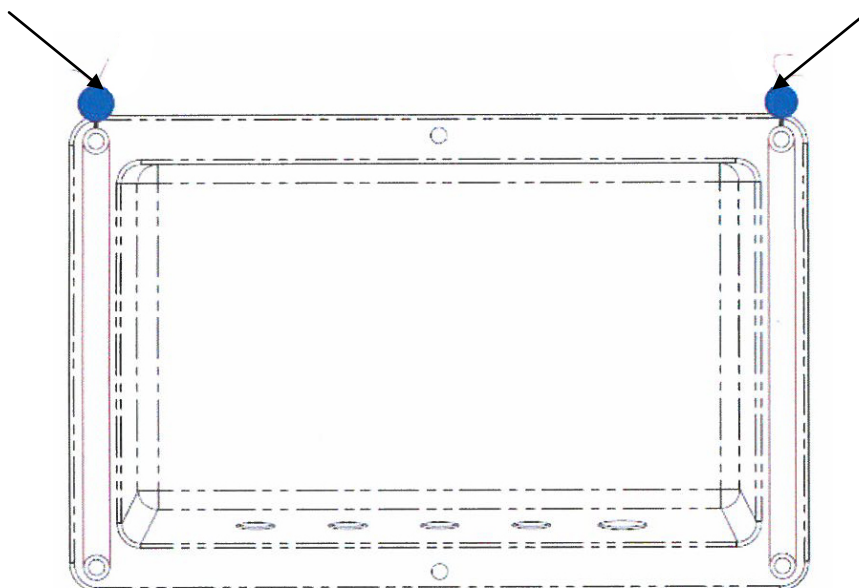

## Notes on verified weighing systems

- In verified weighing systems the menu items <P1rEF>, <P3CAL>, <P5unt>, <P6ZCL> and <P7rSt> will be locked.  
To undo the lock, you have to break the seal and open the casing. On the board move the adjusting switch **SWA1** to position „**ADJ**”.

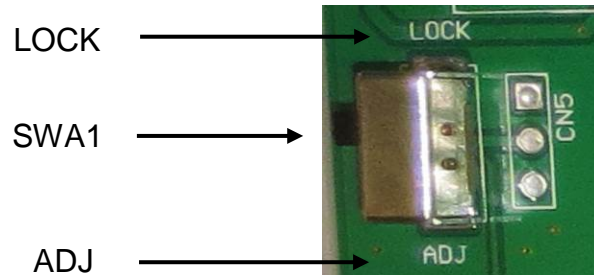

### Attention:

After destruction of the sealing the weighing system must be re-verified by an authorised agency and a new sealing fitted before it can be reused for applications subject to verification.

## 8 Basic Operation

### 8.1 Start-up

- ⇒ Press on/ off key, the equipment completes a self check. As soon as the weight display appears, the instrument will be ready to weigh.



### 8.2 Switching Off

- ⇒ Press the on/ off key approx. 3 seconds, the display will turn off.

### 8.3 Zeroing

Resetting to zero corrects the influence of light soiling on the weighing plate.

#### Manual

- ⇒ To unload the weighing system
- ⇒ Press the ZERO button, the zero display and the indicator '→0←' will appear.



#### Automatic

- ⇒ You can enable or disable the automatic zero tracking mechanism, function „AZn0“, see chap. 11.  
When the balance is cleared the zero point is corrected automatically.

### 8.4 Simple weighing

- ⇒ Place goods to be weighed on balance.
- ⇒ Wait until the indicator ▼ over the stability display appears.
- ⇒ Read weighing result.

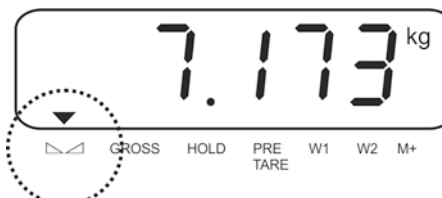

## 8.5 Switch-over weighing unit (only not verifiable weighing systems)

### How to enable weighing units:

⇒ Call-up menu item **P5 Unt**, see chap. 11

P5Unt

⇒ Press , the first weighing unit will be shown.

G

⇒ Press , the current setting will be displayed.

on

⇒ To enable [on] / disable [off] the weighing unit, press 

⇕  
off

⇒ Acknowledge with . The next unit will be shown.

Lb

⇒ To enable [off] / disable [on] the displayed weighing unit, press .

⇒ Acknowledge with .

⇒ Repeat sequence for each weighing unit.

⇒ Return to weighing mode using 

### Switch-over weighing unit:

Keep  pressed, the display changes over to the weighing units activated before (e.g. kg ⇌ lb)



## 8.6 Weighing with tare

### 8.6.1 Taring

- ⇒ Deposit weighing container. After successful stability check press the TARE button. Zero display and indicator NET appear.



The weight of the container is now internally saved.

- ⇒ Weigh the material, the net weight will be indicated.
- ⇒ The weight of the weighing container will be displayed as a minus number after removing the weighing container.
- ⇒ The tare procedure can be repeated as many times as necessary, for example with initial weighing of several components for a mix (add-on weighing). The limit is reached when the taring range capacity (see type plate) is full.
- ⇒ Press the BG/NET-key to switch between gross and net weight.
- ⇒ To delete the tare value, remove load from weighing pan and press the **TARE**-key.  
The NET indicator turns off, the zero display shows.

### 8.6.2 Numerical input of tare (PRE-TARE)

The known dead weight of a weighing container can be tared off by entering its weight as pre-tare deduction in order to ensure the net weight of the goods to be weighed in subsequent weighings is always displayed.

- ⇒ Press TARE-key on unloaded weighing scale / zero display and the enabled place will start flashing.

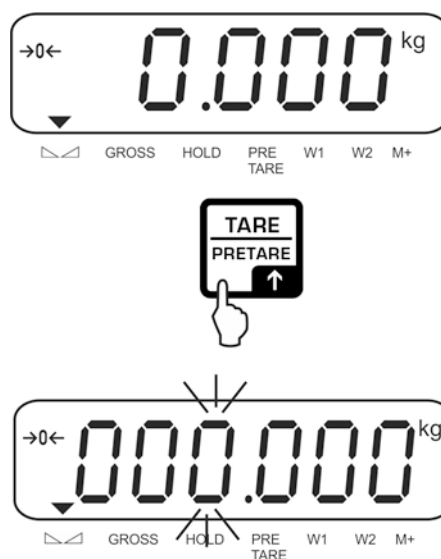

- ⇒ Enter known tare weight (e.g. 2 kg) by operating the navigation keys and confirm by pressing the zero key. Numerical input, see chap. 3.1.

The entered weight will be stored as tare weight and displayed with negative sign. The indicator ▼ over PRE-TARE will appear.



- ⇒ Put the filled weighing container on the balance, the net weight will be displayed.
- ⇒ The tare value remains stored until it is deleted with the TARE key.

### 8.7 Display gross / net

By repeated pressing of the BG/ NET key you can change between the gross and net indicator values.

At the indicator „gross weight“ the indicator appears ▼ above **GROSS**.

In the „Net weight“ display the indicator appears next to **NET**.



## 9 General functions

### 9.1 Automatic shutdown function

The unit is automatically switched off within the preset time when the display unit or the weighing bridge are not operated.

⇒ Keep  pressed in weighing mode for approx. 3 seconds until "setbl" is displayed.

SEtbl



⇒ Press  to invoke auto switch-off function

SEtoF

⇒ Press , the current setting will be displayed.

⇒ Press  to select the desired setting.

- of 0** Function disabled
- of 3** Weighing system will be turned off after 3 min.
- of 5** Weighing system will be turned off after 5 min.
- of 15** Weighing system will be turned off after 15 min.
- of 30** Weighing system will be turned off after 30 min.

⇒ Either save by  or cancel by pressing .

Back to Weighing mode by .

## 9.2 Display background illumination



⇒ Keep  pressed in weighing mode for approx. 3 seconds until “setbl” is displayed.



⇒ Press  again, the current setting will be displayed.

⇒ Press  to select the desired setting.

<b>bl off</b>	Display background illumination off
<b>bl on</b>	Starting from a weight > 10 d the back lighting of the display is switched on automatically. If there is no activity at the appliance for 10 seconds or at the zero indicator the back lighting is switched off automatically.

⇒ Either save by  or cancel input by pressing .

Back to Weighing mode by .

## 10 Operation Modes

### 10.1 Parts counting

Before the balance can count parts, it must know the average part weight (i.e. reference). Proceed by putting on a certain number of the parts to be counted. The balance determines the total weight and divides it by the number of parts, the so-called reference quantity. Counting is then carried out on the basis of the calculated average piece weight.

As a rule:

The higher the reference quantity the higher the counting exactness.

- ⇒ In weighing mode , press and hold until the message „P 10“ appears that is used to set the reference quantity.

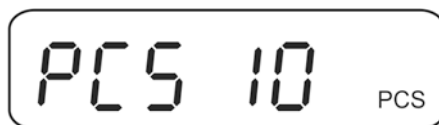

- ⇒ Use  to set the desired reference quantity (e.g. 100), selectable 10, 20, 50, 100 or 200

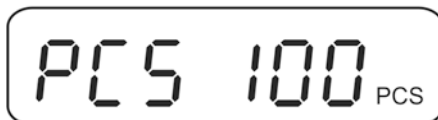

- ⇒ Place as many parts to be counted (e.g. 100 items) as required by the reference number of parts.

Acknowledge with . The weighing scales calculate the reference weight. The current quantity (such as 100 items) will be displayed.

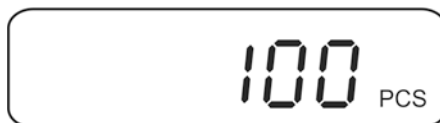

- ⇒ Remove reference weight. The balance is from now in parts counting mode counting all units on the weighing plate.



- ⇒ Back to Weighing mode by .

## Automatic reference optimization

- Menu setting:  
**i** „P4 OTH“ ⇒ „AVeRg“ ⇒ „on“, see chap. 11

In order to improve the counting exactness, the reference can be optimised by adding more pieces. At every reference optimisation, the reference weight is calculated anew. As the additional pieces increase the base for the calculation, the reference also becomes more exact.

If the number of placed parts are 5 pieces more than the reference, then the automatic reference optimisation starts. The reference weight is calculated anew.

## 10.2 Manual totalizing

With this function the individual weighing values are added into the summation memory by pressing  and edited, when an optional printer is connected.

- i** • Menu setting:  
„P2 COM“ ⇒ „MODE“ ⇒ „PR2““, see chap. 11
- The totalizing function is not active when the weight is under 20d.

### Add up:

⇒ Place weighing good A, e.g. 5 kg.

Wait for stability, then press . The weight value is added to the summation memory and printed if an optional printer is connected. The number of weighings, followed by the total weight will be indicated.

The indicator ▼ above M+ shows.

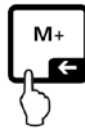

⇒ Remove the weighed good. More weighed goods can only be added when the display  $\leq$  zero.



⇒ Place goods to be weighed, e.g. 3 kg.

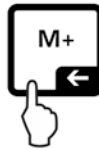

Wait for stability, then press  added. The weight value is added to the summation memory and edited on a connected optional printer. Number of weighings, followed by the total weight will be displayed for 2 sec. Then the current weight value appears, the indicator ▼ above M + appears.



⇒ Add more weighed goods as described before.



This process may be repeated 99 times or till such time as the capacity of the weighing system has been exhausted.

#### Display and edit sum „Total“:

⇒ Press , the number of weighings, followed by the total weight will be displayed for 2 sec. Press  to print out this display.







**Delete weighing data:**





⇒ Press  and  at the same time The data in the summation memory are deleted.

**Sample logs:**

Menu setting  
 “P2 COM“ ⇒ “Lab 2“ / “Prt 1“

*****		
No.:	1	First weighing
G	5,000kg	
C	5,000kg	
*****		
*****		
No.:	2	Second weighing
G	3,000kg	
C	8,000kg	
*****		
*****		
No.:	3	Third weighing
G	2,000kg	
C	10,000kg	
*****		
*****		
Total		Number of weightings/ Total sum
No.:	3	
C	10,000kg	 + 
*****		

Menu setting  
 „P2 COM“ ⇒ „Lab 0“ / “Prt 0“

*****		
G	5,000kg	First weighing
*****		
*****		
*****		
G	3,000kg	Second weighing
*****		
*****		
*****		
G	2,000kg	Third weighing
*****		
*****		
*****		
Total		Number of weightings/ Total
No.:	3	
C	10,000kg	 + 
*****		

**i** For additional output formats see chap. 13.2

### 10.3 Automatic adding-up

With this function the individual weighing values are automatically added into the summation memory without pressing a key when the balance is unloaded and edited, when an optional printer is connected.

- i** • Menu setting:  
„P2 COM“ ⇒ „MODE“ ⇒ „AUTO“, see chap. 11



#### Add up:

- ⇒ Place load A.  
After completion of the stability control, the weight value will be printed and added to the summation memory.
- ⇒ Remove the weighed good. More weighed goods can only be added when the display  $\leq$  zero.
- ⇒ Place good to be weighed B.  
After completion of the stability control, the weight value will be printed and added to the summation memory. Number of weighings, followed by the total weight will be displayed for 2 sec.
- ⇒ Add more weighed goods as described before.  
Please note that the weighing system must be unloaded between the individual weighing procedures.
- ⇒ This process may be repeated 99 times or till such time as the capacity of the weighing system has been exhausted.

- i** For how to display and delete weighing data as well as sample logs see chap. 10.2

## 10.4 Data-Hold functions

- i** • Menu setting:  
„P4 OTH“ ⇒ „ANM“ ⇒ „ON““, see chap. 11

⇒ Press  +  simultaneously when the function is enabled. The current setting will be displayed.

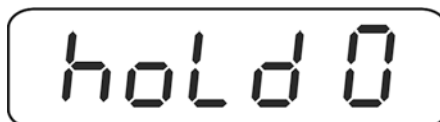

⇒ Press  to select the desired setting.

<b>hold 0</b>	Function switched off (factory setting)
<b>hold 1</b>	<b>Peak value function</b> This function indicates the highest load factor (peak value) of a continuously rising load. The peak value remains in the display until it is deleted with any key.
<b>hold 2</b>	<b>„Stable hold 1“ mode</b> The weight value is held automatically after reaching a stable value up to the manipulation of any key in the display.
<b>hold 3</b>	<b>„Stable hold 2“ mode</b> The weight value is held in the display after reaching a stable value until the load falls under 10d.
<b>hold 4</b>	<b>Animal weighing</b> This function is suitable for jerky weighing procedures, see following chapter 10.4.1

⇒ Confirm input by  .

## 10.4.1 Animal weighing function

With this function jerky balancing goods can be weighed, e.g. living animals. The scale calculates an average value by the number of adjusted weighings and displays this until the scale is cleared (display < 10d).

### Settings:

⇒ Call up setting "hold 4", see chap. 10.4

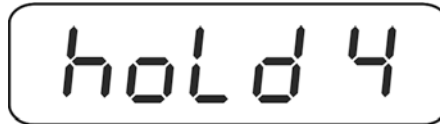

⇒ Press , the current setting will be displayed.

⇒ With the navigation keys (see chapter 3.1) select the desired setting.

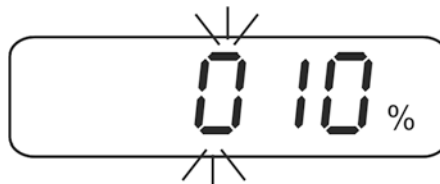

1%	Range of display fluctuation, you can select 1 -100%. Factory setting „10“
↓	
100%	

⇒ Press  to confirm entry and the current setting "number of weighings" will be displayed.



⇒ Press  to select the desired setting.

1	Number of weighings, which are consulted for the average value calculation, you can select 1, 2, 4, 8, 16, 32, 64. Factory setting "8"
↓	
64	

⇒ Acknowledge with . From now on the scale is in animal weighing mode.

### Animal weighing:

When the animal weighing function is activated horizontal segments appear at the zero display.



⇒ Place goods to be weighed on the balance. The scale calculates the average value by the number of adjusted weight readings. The indicator ▼ appears above HOLD.



⇒ For further measurements unload the scale.



## 10.5 Weighing with tolerance range

You can set an upper or lower limit when weighing with tolerance range and thus ensure that the weighed load remains exactly within the set limits.

During tolerance tests such as dosing, portioning and sorting the unit will indicate exceeded or undershot limits by emitting an optical or acoustic signal.



### Audio signal:

The acoustic signal depends on the settings in menu block <BEEP>.

Options:

- no Acoustic signal turned off
- ok An acoustic signal sounds when load is within tolerance limits
- ng An acoustic signal sounds when load is beyond tolerance limits

### Optical signal:

The indicators    show whether the load is within the two set tolerance limits.



Target quantity / target weight below minimum tolerance limit



Target quantity / target weight within tolerance range



Target quantity / target weight exceeds maximum tolerance limit

The settings for tolerance check may be called up either via menu block „**PO CHK**“ (see chap. 11) or faster via the key combination

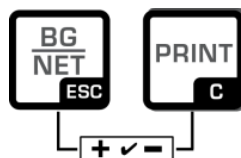

### 10.5.1 Tolerance check for target weight

#### Settings:

⇒ In weighing mode, press the BG- and the PRINT-key simultaneously.

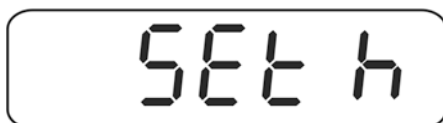

⇒ The screen <SET h> used to enter the upper limit will be displayed. Press the ZERO key, the current setting appears.



⇒ Press the navigation keys (See chap. 3.1) to enter the upper limit, e.g. 1100 kg; the currently enabled digit will be flashing.



⇒ Confirm entry by ZERO button.

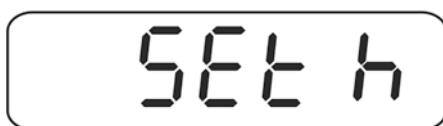

⇒ Press the TARE key, the screen used to enter the lower limit will appear.

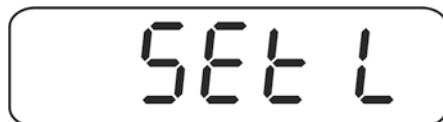

⇒ Press the ZERO key, the current setting appears.



- ⇒ To enter the lower limit, e. g. 1000 Kg, press the navigation keys (See chap. 3.1); the currently enabled digit will be flashing.



- ⇒ Confirm entry by ZERO button.

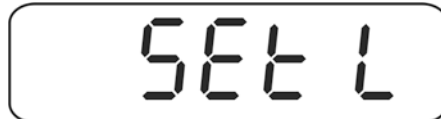

- ⇒ Press the TARE-key repeatedly until bEEP is displayed.

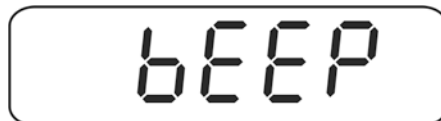

- ⇒ Press the ZERO key, the current setting for the acoustic signal will be shown.



- ⇒ Press the TARE key to select the desired setting (no, ok, ng). To confirm, press the ZERO key.



- ⇒ To exit the menu, press the BG-key. The weighing system is in tolerance weighing mode. From here evaluation takes place whether the goods to be weighed are within the two tolerance limits.











## Weighing with tolerance range

⇒ Tare when using a weighing container.

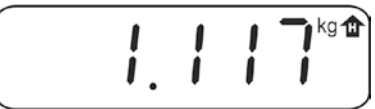
⇒ Put on goods to be weighed, tolerance control is started. The indicators show whether the load is within the two set tolerance limits.

Load below specified tolerance	Load within specified tolerance	Load exceeds specified tolerance
 <p>Indicator  will be displayed</p>	 <p>Indicator  will be displayed</p>	 <p>Indicator  will be displayed</p>



- The tolerance control is not active when the weight is under 20d.
- To delete limits, enter value "000.000 kg" every time.

## 10.5.2 Tolerance check for target quantity

### Settings:

⇒ In weighing mode, press the BG and the PRINT key simultaneously.

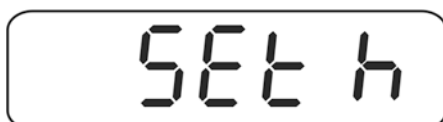

⇒ Press the TARE key repeatedly until the screen to enter the upper limit value *PCS H* is displayed.

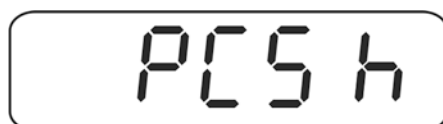

⇒ Press the ZERO key, current setting appears.



⇒ To enter the upper limit, e. g. 100 items, press the navigation buttons (see chap. 3.1); the currently enabled digit will be flashing.



⇒ Confirm entry by ZERO button.

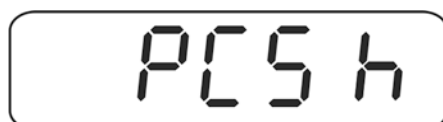

⇒ Press the TARE key and the screen used to enter the lower limit will appear.

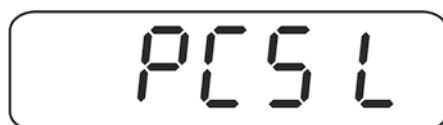

⇒ Press the ZERO key, the current setting appears.



⇒ To enter the lower limit, e. g. 75 items, press the navigation buttons (see chap. 3.1); the currently enabled digit will be flashing.



⇒ Confirm entry by ZERO button.



⇒ Press the TARE-key repeatedly until bEEP is displayed.

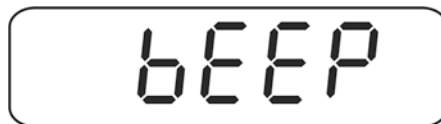

⇒ Press the ZERO key, the current setting for the acoustic signal will be shown.



⇒ Press the TARE key to select the desired setting (no, ok, ng). To confirm the entry, press the ZERO key.

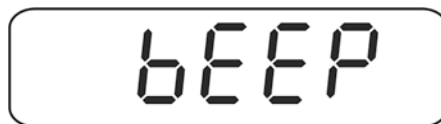

⇒ To exit the menu, press the BG-key. The weighing system is in tolerance weighing mode. From here evaluation takes place whether the goods to be weighed are within the two tolerance limits.



## Counting to target quantity

- ⇒ Determine the item weight, see chap. 10.1
- ⇒ Tare when using a weighing container.
- ⇒ Put on goods to be weighed, tolerance control is started. The indicators show whether the load is within the two set tolerance limits.











Weighed load below specified tolerance	Weighed load within specified tolerance	Weighed load exceeds specified tolerance
		
Indicator  will be displayed	Indicator  will be displayed	Indicator  will be displayed



- The tolerance control is not active when the weight is under 20d.
- To delete limits, enter „000000 PCS“.

## 11 Menu

### Navigation in the menu:

<p><b>Call up menu</b></p>	<p>⇒ Switch-on balance and during the selftest press  . &lt;Pn&gt; will be shown.</p> <div style="text-align: center; border: 1px solid black; padding: 5px; width: fit-content; margin: 10px auto;">Pn</div> <p>⇒ Press , ,  subsequently, the first menu block „PO CHK“ will be displayed.</p> <div style="text-align: center; border: 1px solid black; padding: 5px; width: fit-content; margin: 10px auto;">POCHK</div>
<p><b>Select menu block</b></p>	<p>⇒ With help of , the individual menu block can be selected one after the other.</p>
<p><b>Select setting</b></p>	<p>⇒ Confirm selected menu item by pressing . The current setting will be displayed.</p>
<p><b>Change settings</b></p>	<p>⇒ To change to the available settings, press .</p>
<p><b>Acknowledge setting / exit the menu</b></p>	<p>⇒ Either save by  or cancel by pressing .</p>
<p><b>Return to weighing mode</b></p>	<p>⇒ Press  repeatedly to exit menu.</p>



## 11.1 Overview non-verified weighing systems (Adjustment switch in position <Adj>, see chap. 7.9)

Menu block Main menu	Menu item Submenu	Available settings / explanation		
P0 ChK <b>Weighing with tolerance range</b>	SEt h	Upper limit value „Tolerance check weighing“, input see chap. 10.5.1		
	SEt L	Lower limit value „Tolerance check weighing“, input see chap. 10.5.1		
	PCS h	Upper limit value „Tolerance check counting“, input see chap. 10.5.2		
	PCS L	Lower limit value „Tolerance check counting“, input see chap. 10.5.2		
	bEEP	no	Acoustic signal for weighing with tolerance range switched off	
		oK*	Acoustic signal when weighed load is within tolerance limits	
		nG	Acoustic signal when weighed load is beyond tolerance limits	
P1 rEF <b>Zero point settings</b>	A2n0	Automatic zero setting range, digits selectable (0* – 9 d)		
	0Auto	Switch-on zero setting range Load range where the display after switching-on the balance is set to zero. Selectable 0, 2, 5, 10*, 20, 30, 50, 100 %		
	0rAGE	Manual zero setting range Load range by setting the display to zero after pressing the ZERO-key. Selectable 0, 2*, 4, 10 , 20* , 50, 100%.		
	0rECr	While the function is enabled the last zero point will be saved. After switching the appliance off and on or after a power failure the equipment with the stored zero point continues to work. Selectable on / off*		
	0tACE	Auto Zero function, selectable <on* / off> While the scale is unloaded minor weight fluctuations will be corrected automatically. In the event that small quantities are removed or added to the material to be weighed, incorrect weighing results can be displayed due to the “stability compensation”. (Example: Slowly draining fluids from a container on the balance). When apportioning involves small variations of weight, it is advisable to switch off this function.		
	FiL	Filter settings, selectable 0* - 9 < 0 >: Calm and stable environment		
		 < 9 >: Busy environment		

	SPEEd	Reaction speed, selectable 0, 1, 2, 3, 4, 5*, 6, 7, 8, 9	
		< 0 >: Sensitive/fast	
		↑ ↓	
		< 9 >: Insensitive / slow	
P2 CoM Interface parameter	ModE	St1*	One output for stable weighing value. Return to zero needed between values.
		St2	One output for stable weighing value. No return to zero needed between values.
		StC	Continuous data output of stable weighing values
		Pr1	An issue takes place after pressing the PRINT key.
		Pr2	Manual totalizing, see chap. 10.2 The weight value will be added into the summation memory and issued after the M+-key was pressed.
		Auto	For automatic totalizing see chap. 10.3 This function is used to issue and add individual weighing values automatically to the summation memory on unloading of weighing scale.
		CoMAnd	For remote control commands, see chap. 13.4
		Cont	Continuous data output
	bAud	Available baud rate: 600, 1200, 2400, 4800, 9600*, 19200	
	Pr	E71	7 bits, even parity
		o71	7 bits, odd parity
		n81*	8 bits, no parity
	rPS	Continuous data transfer Select interval 1, 2, 4, 8 16 or MAX*	
	PTyPE	PtUP*	Standard printer setting
	LAb	LAb x	For data output format see chap. 13.2 selectable 0*, 1, 2, 3
	Prt	Prt x	
	LAnG	ENG*	Standard settings English
	rtC		Set RTC (date/time)
	rtCFO		Set format for date, selectable <year_month_day> or <day_month_year>
	rS485		Enter ID for RS485 interface
	bLAnK	off*	Print a blank line on output format
on			

P3 CAL <b>Configuration data</b>	dECi	Position of the decimal dot		
	MuLt	Setting balance type, capacity (Max) and readability (d)		
		SinGLE	Single-range balance	
			div 1	Readability
			CAP 1	Capacity
			End	Exit menu <b>Either</b> import weighing scale type settings by pressing the Zero-key <b>or</b> cancel by pressing the ESC-key
		duAL	Dual range balance	
			div 1	Readability 1st weighing range
			CAP 1	Capacity 1st weighing range
			div 2	Readability 2nd weighing range
			CAP 2	Capacity 2nd weighing range
	tyPE		rAnGE   Multi-range balance intEr   Multi-interval balance	
	End	Exit menu <b>Either</b> import weighing scale type settings by pressing the Zero-key <b>or</b> cancel by pressing the ESC-key		
CAL	noLin	Adjustment, see chap. 7.7.1		
	LinEr	Linearisation, see chap. 7.8		
GrA	Gravitation constant at place of installation			
GrL	Gravitation constant applied during verification			
V tESt	Not documented			
P4 oth <b>General parameters</b>	AnM	Animal weighing (See chap.10.4), selectable on / off*		
	AVErG	Automatic reference optimisation (See chap.10.1), selectable on / off* When this function is enabled the device will automatically redefine the single weight if the number of parts has increased.		
	rtAr	Tare range		
	St	Multi-tare selectable on / off*		
	FtFnC	Functions of foot switch, selectable Zero*, tArE, Print		



P5 Unt <b>Switch-over weighing unit,</b> see chap. 8.5	g	on	Enable units accessible via the BG-key	
		off*		
	lb	on		
		off*		
	oz	on		
		off*		
	tJ	on		Not documented
		off		
HJ	on			
	off			
viSS	on			
	off			
P6 ZCL	For external adjustment, see chap. 7.7.2			
P7 rst			Use  to reset balance settings to factory default.	

**Factory settings are marked by \*.**

## 11.2 Overview verified weighing systems (Adjustment switch in position <Lock>, see chap. 7.9)

Menu block Main menu	Menu item Submenu	Available settings / explanation		
P0 ChK  Weighing with tolerance range	SEt h	Upper limit value „Tolerance check weighing“, input see chap. 10.5.1		
	sEt L	Lower limit value „Tolerance check weighing“, input see chap. 10.5.1		
	PCS h	Upper limit value „Tolerance check counting“, input see chap. 10.5.2		
	PCS L	Lower limit value „Tolerance check counting“, input see chap. 10.5.2		
	bEEP	no	Acoustic signal for weighing with tolerance range switched off	
	oK*	Acoustic signal when weighed load is within tolerance limits		
	nG	Acoustic signal when weighed load is beyond tolerance limits		
P2 CoM  Interface parameter	ModE	St1*	One output for stable weighing value. Return to zero needed between values.	
		St2	One output for stable weighing value. No return to zero needed between values.	
		StC	Continuous data output of stable weighing values	
		Pr1	An issue takes place after pressing the PRINT key.	
		Pr2	Manual totalizing, see chap. 10.2 The weight value will be added into the summation memory and issued after the M+-key was pressed.	
		Auto	For automatic totalizing see chap. 10.3 This function is used to issue and add individual weighing values automatically to the summation memory on unloading of weighing scale.	
		CoMAnd	For remote control commands, see chap. 13.4	
		Cont	Continuous data output	
	bAud	Available baud rate: 600, 1200, 2400, 4800, 9600*, 19200		
	Pr	E71	7 bits, even parity	
		o71	7 bits, odd parity	
		n81*	8 bits, no parity	
	rPS	Continuous data transfer Select interval 1, 2, 4, 8 16 or MAX*		
	PTYPE	PtUP*	Standard printer setting	
	LAb	LAb x	Data output format, selectable 0*, 1, 2, 3	
	Prt	Prt x	For sample logs see chap. 13.2	
	LAnG	ENG*	Standard settings English	
	rtC		How to set date/time	
	rtCFO		Set format for date, selectable <year_month_day> or <day_month_year>	
	rS485		Enter ID for RS485 interface	
bLAnK	off*	Print a blank line on output format		
	on			

<b>P4 oth</b> <b>General parameters</b>	AnM	Animal weighing (see chap.10.4), selectable on / off*	
	AVErG	Automatic reference optimisation (see chap.10.1), selectable on / off* When this function is enabled the device will automatically redefine the single weight if the number of parts has increased.	
	rtAr	Tare range	
	St	Multi-tare selectable on / off*	
	FtFnC	Functions of foot switch, selectable Zero*, tArE, Print	
<b>P5 Unt</b> <b>Switch-over weighing unit,</b> see chap. 8.5	g	on	Enable units accessible via the BG-key     Not documented
		off*	
	lb	on	
		off*	
	oz	on	
		off*	
	tJ	on	
		off	
HJ	on		
	off		
viSS	on		
	off		

Factory settings are marked by \*.

## 12 RS 485 – pin allocation

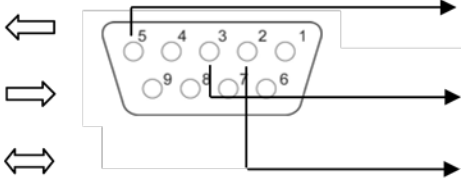
PC	PIN	Function	Female 9 PINS	Function
	2	Transmit Data		SG
	3	Receive Data		DA
	5	Signal Ground		DB

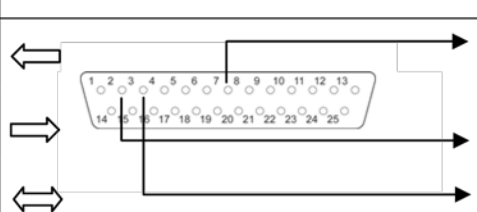
Printer	PIN	Function	Male 25 PINS	Function
	2	Receive Data		SG
	3	Transmit Data		DA
	7	Signal Ground		DB

## 13 RS 232C

You can print weighing data automatically via the RS 232C interface or manually pressing the **PRINT** button via the interface according to the setting in the menu.

This data exchange is asynchronous using ASCII Code.

The following conditions must be met to provide successful communication between the weighing system and the printer.

- Use a suitable cable to connect the display unit to the interface of the printer. Faultless operation requires an adequate KERN interface cable.
- Communication parameters (baud rate, bits and parity) of display unit and printer must match. For a detailed description of interface parameters, please refer to chapter 11, Menu block "P2 COM"

### 13.1 Pin allocation

PC	PIN	Function	Female 9 PINS	
	2	Transmit Data	←	→
	3	Receive Data	→	→
	5	Signal Ground	↔	↔
				Function
				SG
				RxD
				TxD

Printer	PIN	Function	Male 25 PINS	
	2	Receive Data	←	→
	3	Transmit Data	→	→
	7	Signal Ground	↔	↔
				Function
				SG
				RxD
				TxD

### 13.2 Printer operation / sample logs

- Counting

```

*****
PCS                100
*****
    
```

- Totalization

Menu setting P2 Com ➔ Mode ➔ Pr2 or Auto

Lab Prt	0	1	2	3
0	***** G: 5.000kg *****	***** N: 5.000kg T: 5.000kg G: 10.000kg *****	***** G: 5.000kg C: 10.000kg *****	***** N: 5.000kg T: 5.000kg G: 10.000kg C: 10.000kg *****
1	***** No.: 1 G: 5.000kg *****	***** No.: 1 N: 5.000kg T: 5.000kg G: 10.000kg *****	***** No.: 1 G: 5.000kg C: 10.000kg *****	***** No.: 1 N: 5.000kg T: 5.000kg G: 10.000kg C: 10.000kg *****
2	***** 2014-03-14 G: 5.000kg *****	***** 2014-03-14 N: 5.000kg T: 5.000kg G: 10.000kg *****	***** 2014-03-14 G: 5.000kg C: 10.000kg *****	***** 2014-03-14 N: 5.000kg T: 5.000kg G: 10.000kg C: 10.000kg *****
3	***** 2014-03-14 No.: 1 G: 5.000kg *****	***** 2014-03-14 No.: 1 N: 5.000kg T: 5.000kg G: 10.000kg *****	***** 2014-03-14 No.: 1 G: 5.000kg C: 10.000kg *****	***** 2014-03-14 No.: 1 N: 5.000kg T: 5.000kg G: 10.000kg C: 10.000kg *****

### 13.3 Output log (continuous output)

- Weighing

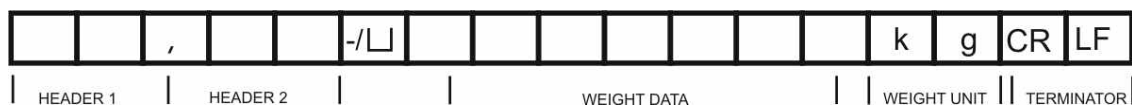

#### Symbols:

ST	Stable value
US	Instable value
G	Gross weight
N	Net weight
T	Tare weight
No	Number weighing processes
C	Total of all individual weighings
<lf>	Space line
PCS	Quantity

### 13.4 Remote control instructions

Com mand	Function	Sample logs
S	Stable weighing value for the weight is sent via the RS232 interface	ST,G,+ 1.000KG
W	Weighing value for the weight (stable or unstable) is sent via the RS232 interface	US,G,+ 1.342KG
R		ST,G,+ 1.000KG
T	No data are sent, the balance carries out the tare function.	-
Z	No data are sent, the zero-display appears.	-
P	Quantity will be sent via the RS232-interface	10pcs

## 13.5 Command Mode

### RS 485:

- ⇒ During input „Id 00“(function RS1 12, see chapter 12.12) the instruction format is the same as with RS232.
- ⇒ During input "ID 01-99" "@ID „must be placed in front of the remote control command, so that the respective scale reacts to the instruction; e. g. to set the scale to zero with ID 99 the instruction must be sent to "@99MZ“ followed by the control characters <CR><LF>.
- ⇒ If there is an error on entered command, letter “E” will show up + “Unidentified Command”.  
e.g. @99MZZ  
The response message is ➔ @99E1MZ.
- ⇒ RS 485 responses only to machines of identified ID-Code.

### 13.5.1 Command Format A

Host	Command		
Slave		Command	
<b>MZ</b>	Zeroing	<b>SO</b>	Command mode
<b>MT</b>	Taring	<b>UA*</b>	Switch to the first unit*
<b>MG</b>	Display gross weight	<b>UB*</b>	Switch to the second unit*
<b>MN</b>	Indicate net weight	<b>UC*</b>	Switch to the third unit *
<b>CT</b>	Delete tare	<b>UD*</b>	Switch to the forth unit *
<b>SC</b>	Continuous data output	<b>UE*</b>	Switch to the fifth unit *
<b>SA</b>	Automatic data output	<b>UF*</b>	Switch to the sixth unit *
<b>%</b>	Stop continuous data output and start instruction mode.		

\* depending on model

### 13.5.2 Command Format B

Host	Command		
Slave		Data	
<b>RW</b>	Send current weight value	<b>RH</b>	Send gross weight without status
<b>RG</b>	Send gross weight	<b>RI</b>	Send net weight without status
<b>RN</b>	Send net weight	<b>RJ</b>	Hi /Lo/ OK status + display value without status
<b>RT</b>	Send tare weight	<b>RK</b>	Hi/Lo/ OK status + gross weight without status
<b>RB</b>	Send the display value without status	<b>RL</b>	Rear one/ Lo/ OK status + net weight without status



Should it be sent continuously, the command must be preceded by %.  
If stable weight values are to be sent, the command must be preceded by #.

### Command Description (RJ, RK, RL, RS)

RJ RK RL	Hi/ Lo/ OK status	Sample display
	Lo (001)	001+ 2.000
	OK (010)	010+ 3.000
	Hi (100)	100+ 4.000
<b>RS</b>	Show tolerance limit RS□□□□ □□: Class (00 ~ 99) * □□ : LO or HI	
	HI	Display of the adjusted upper limit value
	LO	Display adjusted lower limit value
Example: Command RS02LO<CR><LF> Response RS02LOXXXXXX<CR><LF>		

\* depending on model

### 13.5.3 Command Format C

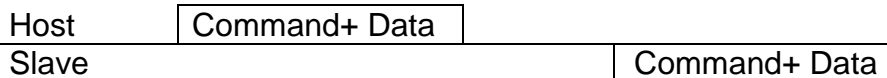

<b>WS</b>	Set tolerance limit WS□□□□ XXXXXX □□: Class (00 ~ 99) * □□ : LO or HI XXXXXX: Enter the limit value	
	HI	Enter the value for the upper limit
	LO	Enter the value for the lower limit
Example: Command WS00HI001000<CR><LF> Response WS00HI001000<CR><LF>		

\* depending on model



### 13.5.4 Command Format D

Host \_\_\_\_\_ Data \_\_\_\_\_  
Slave \_\_\_\_\_

**Answer:**

Value						Position decimal point	CR	LF
1	2	3	4	5	6	1		



12345.6

Display

**Error messages:**

E1: Wrong command

E2: Command format error

E3: Command not recognised

## 14 Bluetooth (Factory option)

**i** For menu settings, see chapter 11:  
„P2 COM“ ⇨ „BAUD“ ⇨ „9600“  
„P2 COM“ ⇨ „Pr“ ⇨ „8n1“

⇒ Click in the task border  with activated Bluetooth.



⇒ Click on „Add device“.

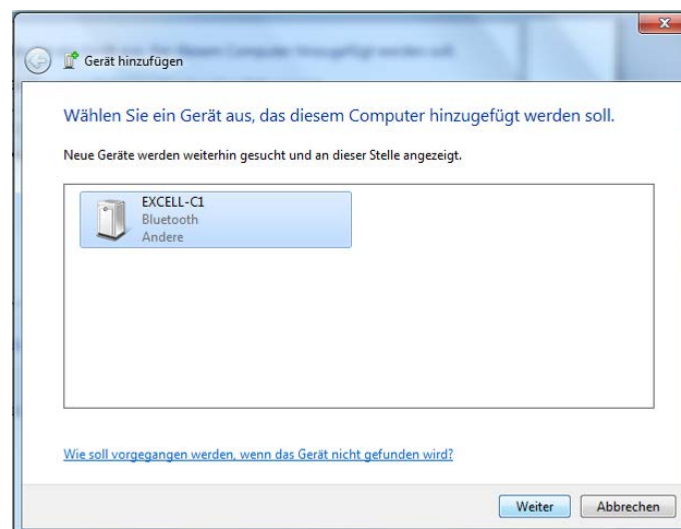
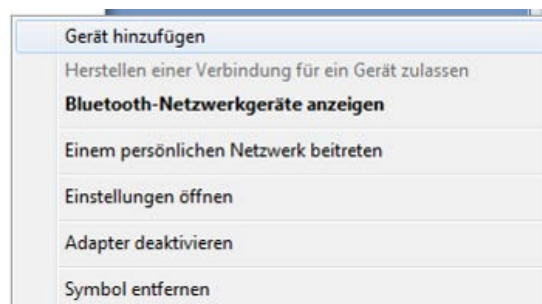

⇒ Click on "Enter pairing code of the device"

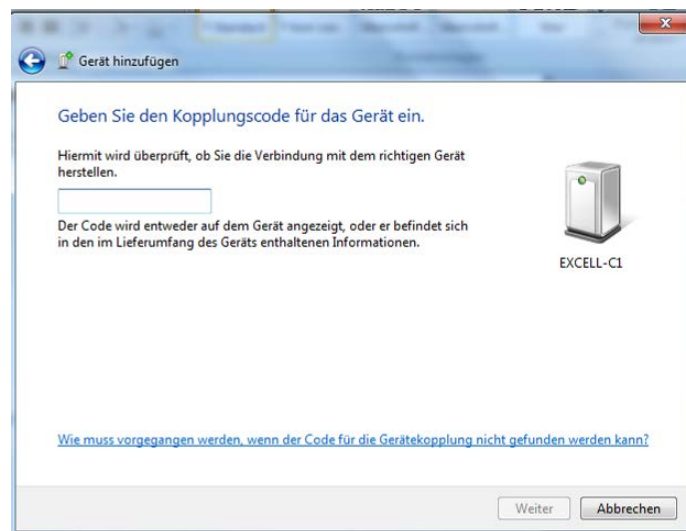
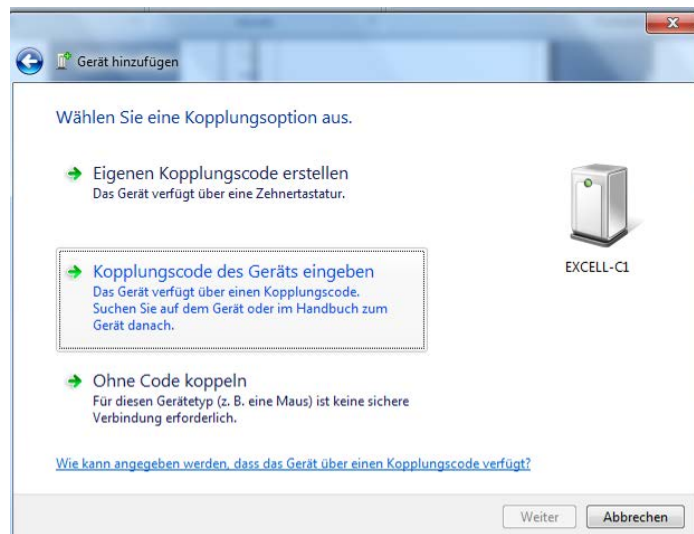

⇒ Enter code 111111

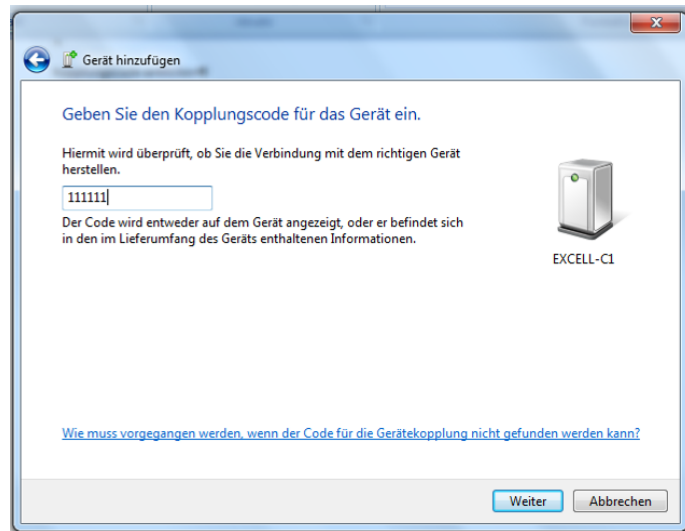

⇒ Click on „Next“

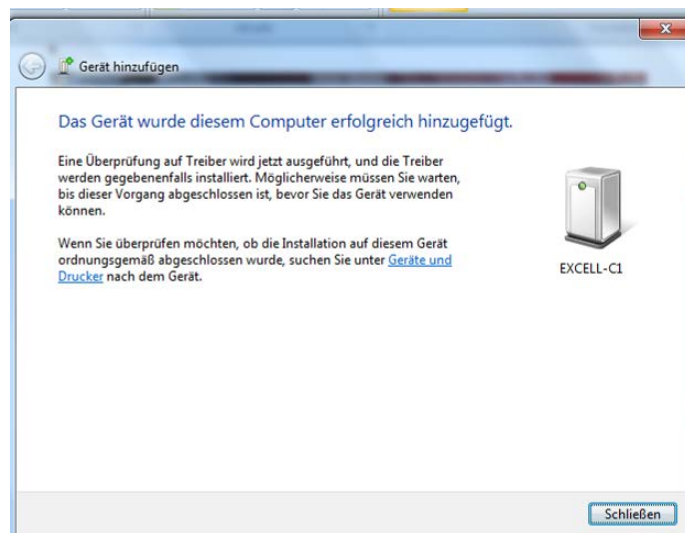

⇒ Click on „Close“

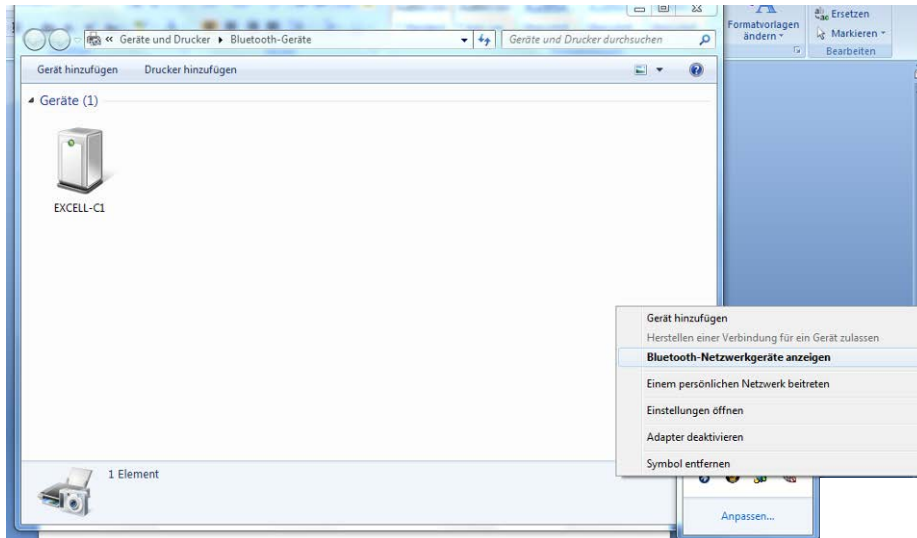

⇒ Display Bluetooth network appliance

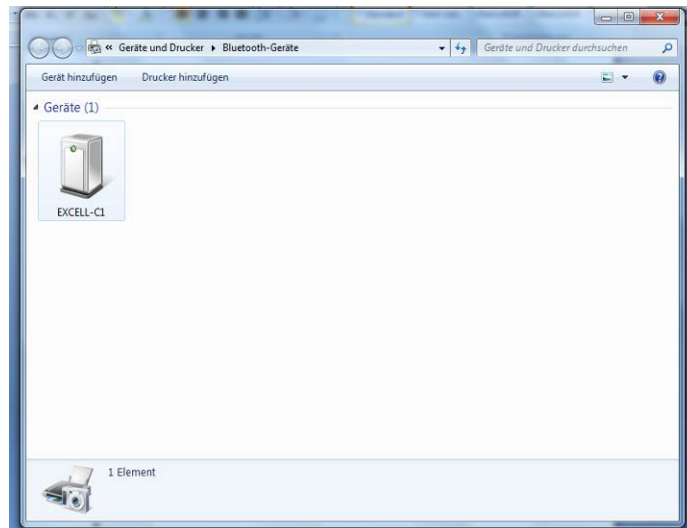

⇒ Double click

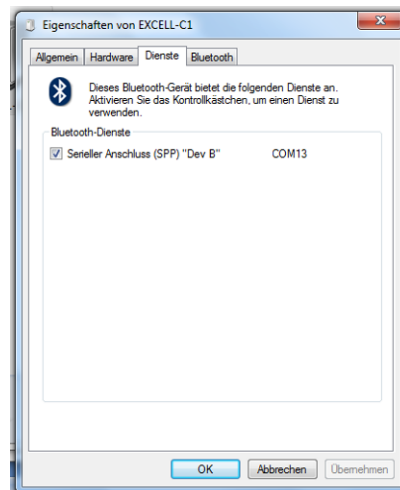

## 15 Installing display unit / weighing bridge

- i** Installation / configuration of a weighing system must be carried out by a well acquainted specialist with the workings of weighing balances.

### 15.1 Technical data

Supply voltage	5 V/150mA
Max. signal voltage	0-10 mV
Zeroing range	0-2 mV
Sensitivity	2-3 mV/V
Resistance parameter	80 - 100 $\Omega$ , max 4 items per 350 $\Omega$ load cell

### 15.2 Weighing system design

The display unit is suitable for connection to any analogue load cell in compliance with the required specifications.

The following data must be established before selecting a load cell:

- **Weighing balance capacity**  
This usually corresponds to the heaviest load to be weighed.
- **Preload**  
This corresponds to the total weight of all parts that are to be placed on the weighing cell such as upper part of platform, weighing pan etc.
- **Total zero setting range**  
This is composed of the start-up zero setting range ( $\pm 2\%$ ) and the zero setting range available to the user via the ZERO-key (2%). The total zero setting range equals therefore 4 % of the scale's capacity.

The addition of weighing scales capacity, preload and the total zero setting range give the required capacity for the weighing cell.

To avoid overloading of the weighing cell, include an additional safety margin.

- **Smallest desired display division**
- **Verifiable, if required**

### 15.3 How to connect the platform

- ⇒ Disconnect the display unit from the power supply.
- ⇒ Solder the individual leads of the load cell cable onto the circuit board, see diagrams below.

#### 4-PIN

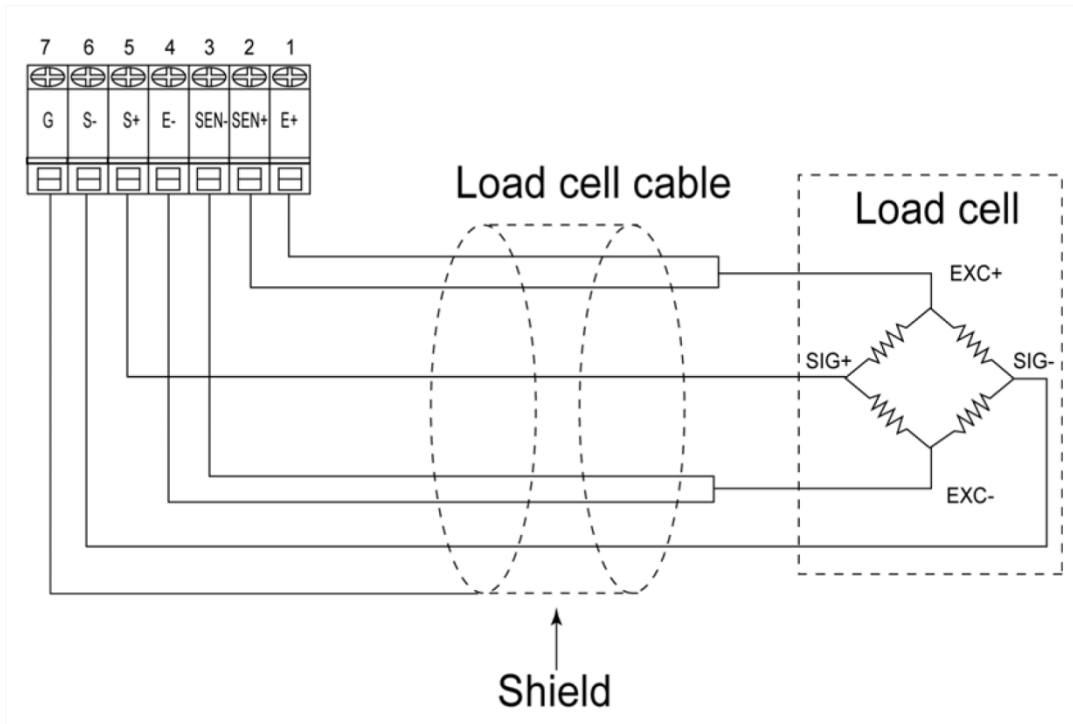

#### 6-PIN

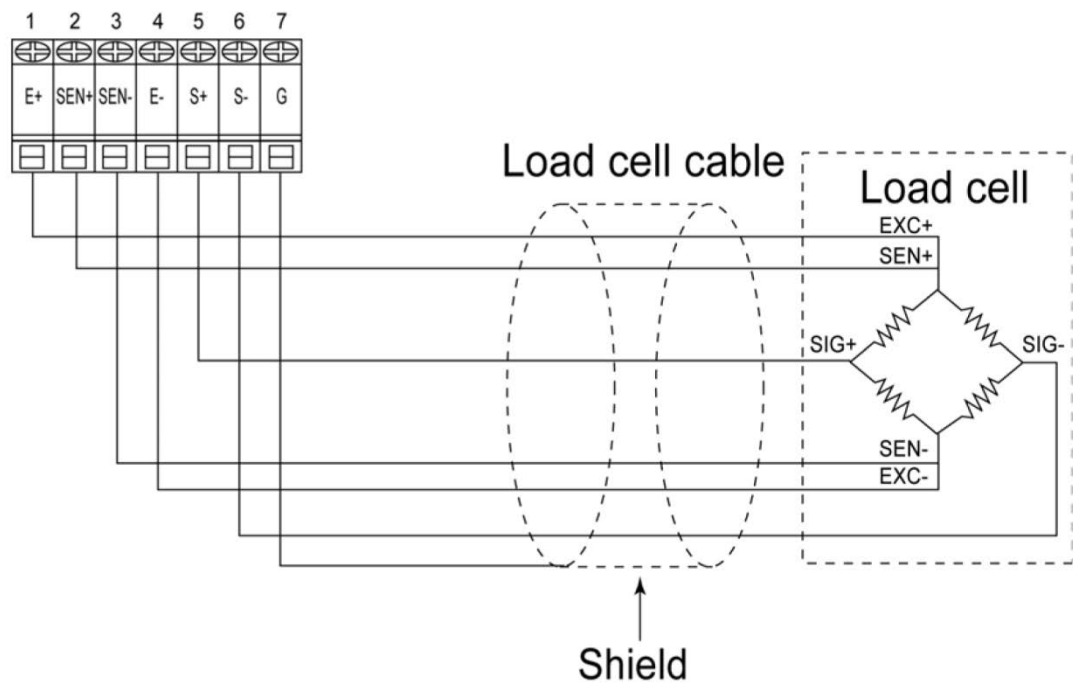

## 15.4 Configure display unit

### Notes on verified weighing systems





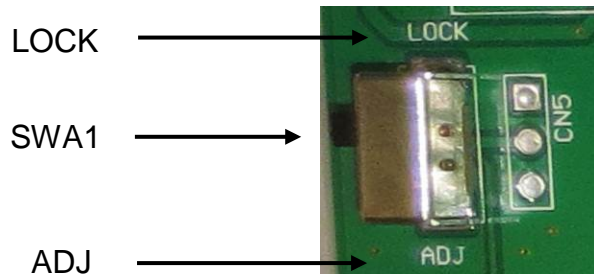



In verified weighing systems menu item <P3CAL> will be locked.

To undo the lock, you have to break the seal and open the casing. On the circuit board move the adjusting switch **SWA1** to position „ADJ”.

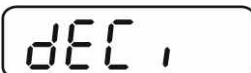
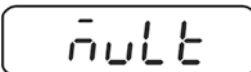

Attention:

After destruction of the sealing the weighing system must be re-verified by an authorised agency and a new sealing fitted before it can be reused for applications subject to verification.

<p>⇒ For invoking menu item &lt;P3CAL&gt; see chap. 11.</p>	
<p>⇒ Press  to display the first menu item for setting decimal place.</p> <p>For configuration press  to select all menu items one by one.</p> <p>Confirm selected menu item with  and the current setting will be shown.</p> <p>Select desired setting with  and acknowledge by .</p>	
<p>1. Decimal place, selectable 0, 0.0, 0.00, 0.000, 0.0000.</p>	
<p>2. Scale type, selectable as single range scale, dual range scale and multi-interval scale (See menu overview in chap. 11.2))</p>	
<p>3. Adjustment / linearization Adjustment or linearization is required after entering configuration data. For how to carry out adjustment see chap. 7.7 or linearization see chap. 7.8</p>	











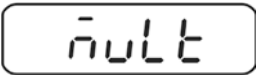

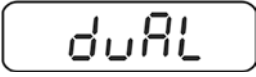



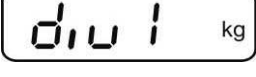









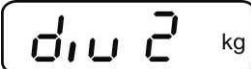

4. Gravitation constant at place of installation	
5. Gravitation constant applied during verification	
⇒ Press  repeatedly to exit menu.	

### 15.4.1 Configuration example single range scale

⇒ Invoke menu item<mult> (see chap. 15.4) and press  to confirm. The currently set balance type is displayed.	
⇒ Press  to select desired type SinGLE = single range scale	
⇒ Press , the screen used to enter readability/verification value will be shown.  ⇒ Press , the current setting will be displayed.  ⇒ Select desired setting with  and acknowledge by .	
⇒ Press  to select next menu item for entering capacity.  ⇒ Press , the current setting will be displayed.  ⇒ Press  to select the desired setting.	
⇒ Confirm by , „End“ will be shown.  ⇒ To import the configuration data, press  again.  ⇒ The entering of configuration data requires subsequent adjustment or linearization. For how to carry out adjustment see chap. 7.7 or linearization see chap. 7.8	  

## 15.4.2 Configuration example dual range scale

<p>⇒ Invoke menu item&lt;mult&gt; (see chap. 15.4) and press  to confirm. The currently set balance type is displayed.</p>	
<p>⇒ Press  to select desired type duAL = dual range scale</p>	
<p>⇒ Press , the display used to enter readability/verification value for first weighing range will appear.</p> <p>⇒ Press , the current setting will be displayed.</p> <p>⇒ Select desired setting with  and acknowledge by .</p>	
<p>⇒ Press  to select the next menu item used to enter the capacity for the first weighing range.</p> <p>⇒ Press , the current setting will be displayed.</p> <p>⇒ Press  to select the desired setting.</p>	

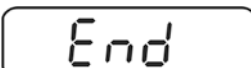
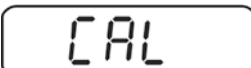
<p>⇒ Press  to enter the next menu item for readability/verification value for second weighing range.</p> <p>⇒ Press , the current setting will be displayed.</p> <p>⇒ Select desired setting with  and acknowledge by .</p>	
<p>⇒ Press  to select the next menu item used to enter the capacity for the second weighing range.</p> <p>⇒ Press , the current setting will be displayed.</p> <p>⇒ Select desired setting with  and acknowledge by .</p>	
<p>⇒ Press  to select next menu item for setting multi-range / multi-interval scale</p> <p>⇒ Press , the current setting will be displayed.</p> <p>⇒ Press  to select desired type rnGE = multi-range scale intEr = multi-interval scale</p>	
<p>⇒ Confirm by , „End“ will be shown.</p> <p>⇒ To import configuration data, press  again.</p>	
<p>⇒ The entering of configuration data requires subsequent adjustment or linearization. For how to carry out adjustment see chap. 7.7 or linearization see chap. 7.8</p>	

## 16 Servicing, maintenance, disposal



Before any maintenance, cleaning and repair work disconnect the appliance from the operating voltage.

### 16.1 Cleaning

- ⇒ Keep IP protection.
- ⇒ Clean the stainless-steel parts with a soft cloth soaked with a cleaning agent suitable for stainless steel.
- ⇒ For stainless steel parts do not use any cleaning agents which contain sodium hydroxide solution, acetic, hydrochloric, sulphuric or citric acid.
- ⇒ Do not use metal brushes or cleaning sponges of steel wool, as this causes superficial corrosion.

### 16.2 Servicing, maintenance

- ⇒ The appliance may only be opened by trained service technicians who are authorized by KERN.
- ⇒ Ensure that the balance is regularly calibrated, see chap. Monitoring of test resources.

### 16.3 Disposal

- ⇒ Disposal of packaging and appliance must be carried out by operator according to valid national or regional law of the location where the appliance is used.

### 16.4 Error messages

Error message	Description
E 0	EEPROM error value outside of A/ D transducer range
E 1	Zero points above the zero adjusting range
E 2	Zero points below zero adjusting range
E 4	A/D converter
oL	Overload
-oL	Underload
oF	Internal value < zero range

Should other error messages occur, switch balance off and then on again. If the error message remains inform manufacturer.

## 17 Instant help

In case of an error in the program process, briefly turn off the display unit and disconnect from power supply. The weighing process must then be restarted from the beginning.

Help:

### Fault

### Possible cause

The displayed weight does not glow.

- The display unit is not switched on.
- Mains power supply interrupted (mains cable defective).
- Power supply interrupted.
- (Rechargeable) batteries are inserted incorrectly or empty
- No (rechargeable) batteries inserted.

The displayed weight is permanently changing

- Draught / air movement
- Table / floor vibrations
- Weighing pan has contact with other objects.
- Electromagnetic fields / static charging (choose different location/switch off interfering device if possible)

The weighing result is obviously incorrect

- The display of the balance is not at zero
- Adjustment is no longer correct.
- Great fluctuations in temperature.
- Warm-up time was ignored.
- Electromagnetic fields / static charging (choose different location/switch off interfering device if possible)

**Importør:**  
**Impex Produkter AS**  
**Gamle Drammensvei 107**  
**1363 Høvik**  
**www.impex.no**  
**info@impex.no**  
**Tel.: 22 32 77 20**