

KERN

KERN & Sohn GmbH

Ziegelei 1
D-72336 Balingen
email: info@kern-sohn.com

Phone: +49-[0]7433- 9933-0
Fax: +49-[0]7433-9933-149
Internet: www.kern-sohn.com

Operating instructions

Bench scales

KERN GAB-N

Version 1.7
2018-01
GB

Importør:
Impex Produkter AS
Gamle Drammensvei 107
1363 Høvik
www.impex.no
info@impex.no
Tel.: 22 32 77 20



GAB-N-BA-e-1817



KERN GAB-N

Version 1.7 2018-01

Operating Instructions Bench Scales

Table of Contents

| | | |
|-----------|--|-----------|
| 1 | Technical Data | 4 |
| 2 | Basic Information (General)..... | 6 |
| 2.1 | Proper use | 6 |
| 2.2 | Improper Use | 6 |
| 2.3 | Warranty | 7 |
| 2.4 | Monitoring of Test Resources..... | 7 |
| 3 | Basic Safety Precautions | 7 |
| 3.1 | Pay attention to the instructions in the Operation Manual..... | 7 |
| 3.2 | Personnel training..... | 7 |
| 4 | Transportation & Storage..... | 8 |
| 4.1 | Testing upon acceptance | 8 |
| 4.2 | Packaging / return transport | 8 |
| 5 | Unpacking, Setup and Commissioning | 8 |
| 5.1 | Installation Site, Location of Use | 8 |
| 5.2 | Unpacking/installation..... | 10 |
| 5.2.1 | Scope of delivery / serial accessories | 11 |
| 5.3 | Mains connection..... | 11 |
| 5.4 | Rechargeable battery operation (option)..... | 12 |
| 5.5 | Connection of peripheral devices | 12 |
| 5.6 | Initial Commissioning..... | 12 |
| 6 | Appliance overview | 13 |
| 7 | Overview of displays | 14 |
| 8 | Keyboard overview..... | 15 |
| 9 | Adjustment | 16 |
| 9.1 | Verified models | 17 |
| 9.2 | Non-verifiable models: | 18 |
| 9.3 | Verification | 19 |
| 9.4 | Linearization (non-verified models only)..... | 21 |
| 10 | Operation..... | 23 |
| 10.1 | Weighing..... | 23 |
| 10.2 | Weighing with tare | 23 |
| 10.3 | Percent weighing | 24 |
| 10.4 | Parts counting..... | 25 |
| 10.5 | Weighing with tolerance range | 26 |
| 10.5.1 | Traffic light function | 26 |
| 10.6 | Manual totalizing..... | 28 |
| 10.7 | Automatic adding-up..... | 30 |
| 11 | The menu..... | 32 |
| 11.1 | Navigation in the menu:..... | 32 |

- 11.1.1 Non verifiable models 32
- 11.1.2 Verifiable models 32
- 11.2 Overview: 33
- 11.2.1 Non verifiable models 33
- 11.2.2 Verifiable models 35
- 12 Data output..... 36**
- 12.1 RS232 interface 36
- 12.1.1 Technical data 36
- 12.1.2 Pin allocation of balance output bushing: 36
- 12.1.3 Explanation of the data transfer..... 37
- 12.2 Remote control instructions 37
- 13 Service, maintenance, disposal..... 38**
- 13.1 Cleaning..... 38
- 13.2 Service, maintenance 38
- 13.3 Disposal 38
- 13.4 Error messages 39
- 14 Instant help..... 40**
- 15 Declaration of -Conformity..... 41**

1 Technical Data

| KERN | GAB 6K1DNM | GAB 15K2DNM | GAB 30K5DNM |
|---|---|--------------|--------------|
| Readability (d) | 1 g /2 g | 2 g /5 g | 5 g /10 g |
| Weighing range (max) | 3 kg /6 kg | 6 kg /15 kg | 15 kg /30 kg |
| Reproducibility | 1 g /2 g | 2 g /5 g | 5 g /10 g |
| Linearity | ± 1 g / 2 g | ± 4 g / 10 g | ± 5 g / 10 g |
| Stabilization time | 2 s | 2 s | 2 s |
| Verification value (e) | 1 g /2 g | 2 g /5 g | 5 g /10 g |
| Verification class | III | III | III |
| Minimum weight (min) | 20 g | 40 g | 100 g |
| Weighing Units | kg | kg | kg |
| Recommended adjusting weight (not supplied) | 6 kg (M1) | 15 kg (F2) | 30 kg (M1) |
| Warm-up time | 10 min. | 10 min. | 10 min. |
| Minimum unit weight at piece count | 0.2 g | 0.5 g | 1 g |
| Admissible ambient conditions | -10° C to +40° C | | |
| Humidity of air | max. 80 % relative (not condensing) | | |
| Weighing surface (mm) | 294 x 225 | | |
| Dimensions of the housing (B x D x H) (mm) | 320 x 330 x 125 | | |
| Electric Supply | Supply voltage: 220V-240V AC 50 Hz Mains adapter: 12 V, 500 mA | | |
| Rechargeable battery, not included | Working life approx. 40 h (with background light) Working life approx. 90 h (without background light) Loading time approx. 12 hrs. | | |
| Net weight (kg) | 4.4 kg | | |
| interface | RS 232C | | |

| KERN | GAB 6K0.05N | GAB 12K0.1N | GAB 30K0.2N |
|---|---|--------------------|--------------------------|
| Readability (d) | 0.05 g | 0.1 g | 0.2 g |
| Weighing range (max) | 6 kg | 12 kg | 30 kg |
| Reproducibility | 0.05 g | 0.1 g | 0.2 g |
| Linearity | ± 0.15 g | ± 0.3 g | ± 0.6 g |
| Stabilization time | 2 s | 2 s | 2 s |
| Weighing Units | kg, g | kg, g | kg, g |
| Recommended adjusting weight (not supplied) | 6 kg (F2) | 12 kg (F2) | 20 kg (F1) 10 kg (F1) |
| Warm-up time | 2 h | 2 h | 2 h |
| Minimum unit weight at piece count | 0.05 g | 0.1 g | 0.2 g |
| Admissible ambient conditions | 0° C to 40° C | | |
| Humidity of air | max. 80 % relative (not condensing) | | |
| Weighing surface (mm) | 294 x 225 | | |
| Dimensions of the housing (B x D x H) (mm) | 320 x 330 x 125 | | |
| Electric Supply | Supply voltage: 220V-240V AC 50 Hz Mains adapter: 12 V, 500 mA | | |
| Rechargeable battery, not included | Working life approx. 40 h (with background light) Working life approx. 90 h (without background light) Loading time approx. 12 hrs. | | |
| Net weight (kg) | 3.06 kg | | |
| interface | RS 232C | | |

Dimensions:

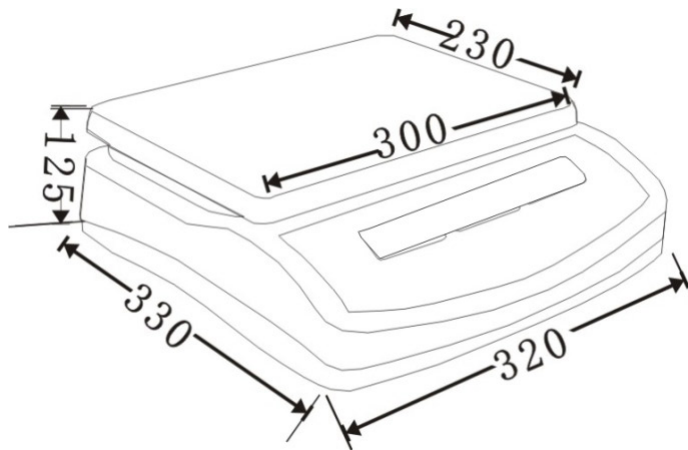

2 Basic Information (General)

2.1 Proper use

The balance you purchased is intended to determine the weighing value of material to be weighed. It is intended to be used as a “non-automatic” balance, i.e. the material to be weighed is manually and carefully placed in the centre of the weighing plate. As soon as a stable weighing value is reached the weighing value can be read.

2.2 Improper Use

Do not use balance for dynamic weighing. In the event that small quantities are removed or added to the material to be weighed, incorrect weighing results can be displayed due to the “stability compensation” in the balance.

(Example: Slowly draining fluids from a container on the balance.)

Do not leave permanent load on the weighing plate. This may damage the measuring system.

Impacts and overloading exceeding the stated maximum load (max) of the balance, minus a possibly existing tare load, must be strictly avoided. Balance may be damaged by this.

Never operate balance in explosive environment. The serial version is not explosion protected.

The structure of the balance may not be modified. This may lead to incorrect weighing results, safety-related faults and destruction of the balance.

The balance may only be used according to the described conditions. Other areas of use must be released by KERN in writing.

2.3 Warranty

Warranty claims shall be voided in case

- Our conditions in the operation manual are ignored
- The appliance is used outside the described uses
- The appliance is modified or opened
- Mechanical damage or damage by media, liquids, natural wear and tear
- The appliance is improperly set up or incorrectly electrically connected
- The measuring system is overloaded

2.4 Monitoring of Test Resources

In the framework of quality assurance the measuring-related properties of the balance and, if applicable, the testing weight, must be checked regularly. The responsible user must define a suitable interval as well as type and scope of this test. Information is available on KERN's home page (www.kern-sohn.com) with regard to the monitoring of balance test substances and the test weights required for this. In KERN's accredited DKD calibration laboratory test weights and balances may be calibrated (return to the national standard) fast and at moderate cost.

3 Basic Safety Precautions

3.1 Pay attention to the instructions in the Operation Manual



Carefully read this operation manual before setup and commissioning, even if you are already familiar with KERN balances.

3.2 Personnel training

The appliance may only be operated and maintained by trained personnel.

4 Transportation & Storage

4.1 Testing upon acceptance

When receiving the appliance, please check packaging immediately, and the appliance itself when unpacking for possible visible damage.

4.2 Packaging / return transport



- ⇒ Keep all parts of the original packaging for a possibly required return.
- ⇒ Only use original packaging for returning.
- ⇒ Prior to dispatch disconnect all cables and remove loose/mobile parts.
- ⇒ Reattach transport securing devices. (see chapter 5.2)
- ⇒ Secure all parts such as the glass wind screen, the weighing platform, power unit etc. against shifting and damage.

5 Unpacking, Setup and Commissioning

5.1 Installation Site, Location of Use

The balances are designed in a way that reliable weighing results are achieved in common conditions of use.

You will work accurately and fast, if you select the right location for your balance.

Therefore, observe the following for the installation site:

- Place scales on a stable, even surface
- Avoid extreme heat as well as temperature fluctuation caused by installing next to a radiator or in the direct sunlight;
- Protect the balance against direct draughts due to open windows and doors;
- Avoid jarring during weighing;
- Protect the balance against high humidity, vapors and dust;
- Do not expose the device to extreme dampness for longer periods of time. Non-permitted condensation (condensation of air humidity on the appliance) may occur if a cold appliance is taken to a considerably warmer environment. In this case, acclimatize the disconnected appliance for ca. 2 hours at room temperature.
- Avoid static charge of goods to be weighed or weighing container.

Major display deviations (incorrect weighing results) may be experienced should electromagnetic fields (e.g. due to mobile phones or radio equipment), static electricity accumulations or instable power supply occur. Change location or remove source of interference.

5.2 Unpacking/installation

Carefully remove the balance from the packaging, remove plastic cover and setup balance at the intended workstation.



Ensure that transport guard has been removed (only existing in 6 kg models)

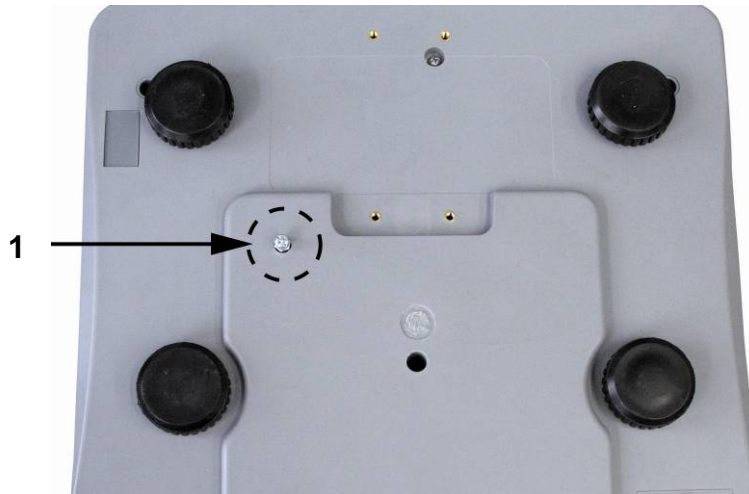

To loosen the transport guard screw out transport screw [1] anticlockwise.

For transportation screw down the transport screw till to the stop in clockwise direction.

⇒ Levelling

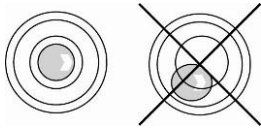

Level balance with foot screws until the air bubble of the water balance is in the prescribed circle.

5.2.1 Scope of delivery / serial accessories

- Balance
- Mains power supply
- Operating instructions

5.3 Mains connection

Power is supplied via the external mains adapter. The stated voltage value must be the same as the local voltage.

Only use original KERN mains adapters. Using other makes requires consent by KERN.

5.4 Rechargeable battery operation (option)

The internal battery is charged with the supplied mains cable.

Before the first use, the rechargeable battery should be charged by connecting it to the mains power cable for at least 15 hours. The operating time of the battery is about 70h. Charging time until complete recharging ca. 12h.

To save battery life, the background light can be switched off in the menu (See chap.. 11 menu).

An arrow [▲] appearing on the weight display below the battery icon  indicates that the capacity of the rechargeable battery is low. The balance will be ready to operate for about another 10 hrs., then it will switch off automatically. Connect the power cable as soon as possible to load the rechargeable battery.

5.5 Connection of peripheral devices

Before connecting or disconnecting of additional devices (printer, PC) to the data interface, always disconnect the balance from the power supply.

With your balance, only use accessories and peripheral devices by KERN, as they are ideally tuned to your balance.

5.6 Initial Commissioning

In order to obtain exact results with the electronic balances, your balance must have reached the operating temperature (see warming up time chap. 1).

During this warming up time the balance must be connected to the power supply (mains, accumulator or battery).

The accuracy of the balance depends on the local acceleration of gravity.

Strictly observe hints in chapter Adjustment.



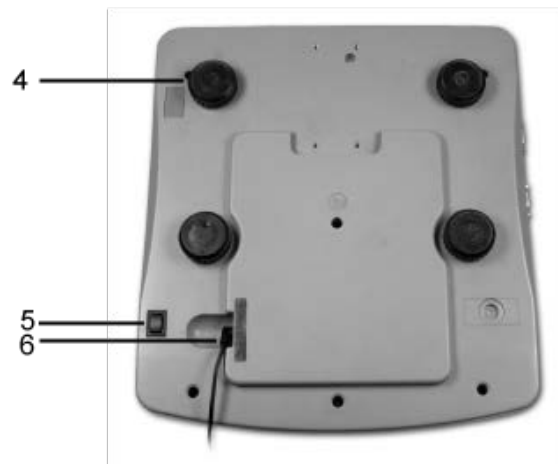

6 Appliance overview

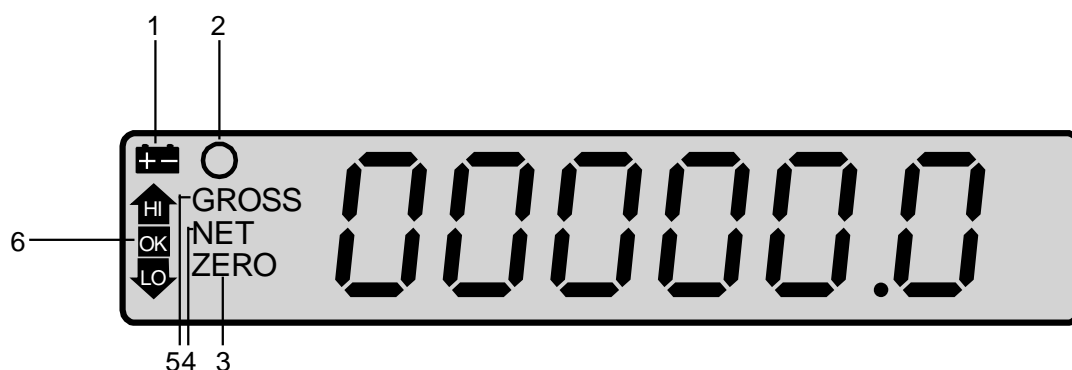

1. Weighing plate / rechargeable battery compartment (under weighing plate)
2. Bubble level
3. RS 232 interface
4. Footscrews
5. ON/OFF switch
6. Mains adapter connection







7 Overview of displays

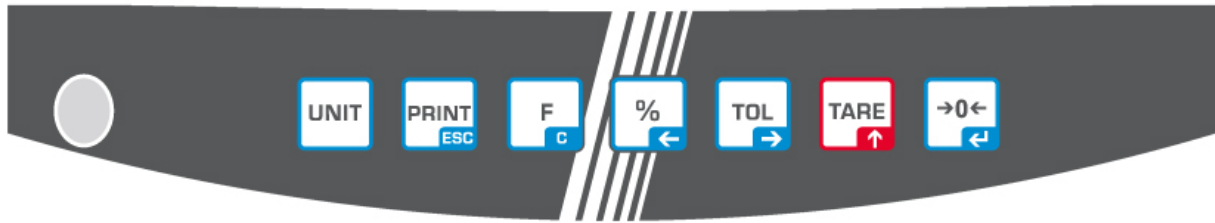

| Display | Designation | Description |
|---------|--|--|
| 1 |  The battery capacity display | Appears when the capacity of the battery is getting low |
| 2 |  Stability display | Scales are in a steady state |
| 3 | ZERO Zeroing display | Should the balance not display exactly zero despite empty scale pan, press the  button. The balance will be set to zero after a short standby time. |
| 4 | NET Net weight display | Displays the net weight |
| 5 | GROSS Gross weight display | Showing gross weight |
| 6 |  Tolerance check Checkweighing | Load above (HI), below (LO) or within (OK) tolerance range |
| |  Power supply connected | Icon is glowing for power supply via power pack |

8 Keyboard overview



| Button | Designation | Function |
|---|---------------------------------|---|
|  | UNIT-key | Weighing units switch-over |
|  | PRINT button | PRINT <ul style="list-style-type: none"> Data transfer via interface Save value to memory if memory function "automatic", is disabled |
| | | ESC <ul style="list-style-type: none"> Return to weighing mode |
|  | Function key | F <ul style="list-style-type: none"> Changes between weighing mode and quantity counting mode |
| | | C <ul style="list-style-type: none"> Delete displayed value |
|  | Percentage key | % <ul style="list-style-type: none"> Weight value displayed in % |
| | | ← <ul style="list-style-type: none"> Move to the left by one decimal point |
|  | Tolerance key Check-weighing | TOL <ul style="list-style-type: none"> Enter upper, lower or both limits |
| | | → <ul style="list-style-type: none"> Move to the right by one decimal point |
|  | Tare key | TARE <ul style="list-style-type: none"> Tare balance |
| | | ↑ <ul style="list-style-type: none"> Increase displayed value |
|  | Zeroing key | 0 <ul style="list-style-type: none"> Reset scales to zero |
| | | ↵ <ul style="list-style-type: none"> Confirm entered value or select function |

9 Adjustment

As the acceleration value due to gravity is not the same at every location on earth, each balance must be coordinated - in compliance with the underlying physical weighing principle - to the existing acceleration due to gravity at its place of location (only if the balance has not already been adjusted to the location in the factory). This adjustment process must be carried out for the first commissioning, after each change of location as well as in case of fluctuating environment temperature. To receive accurate measuring values it is also recommended to adjust the balance periodically in weighing operation.



- For verified balances the adjustment is locked. In order to access the menu you will have to short-circuit the two contacts of the circuit board with a jumper (See chap. 9.3).





Attention:

After destruction of the seal the balance must be re-verified by an authorised agency and a new verification wire/seal mark fitted before it can be reused for applications subject to verification.

Observe the verification notes (see chapter 9.3).

- The weight to be used depends on the capacity of the balance. Carry out adjustment as near as possible to the balance's maximum weight. Info about test weights can be found on the Internet at: <http://www.kern-sohn.com>
- Observe stable environmental conditions. Stabilisation requires a certain warm-up time.

9.1 Verified models

- ⇒ Switch on device via ON-OFF and press the adjustment switch at the same time.
- ⇒ After that, during the balance's selftest, press  and  at the same time. „UnLoAd“ appears.
- ⇒ Acknowledge by . Ensure that there are no objects on the weighing plate.
- ⇒ The currently set adjustment weight will be displayed.
- ⇒ To change by using the navigation buttons (see operating instructions chap. 8) select the desired setting, the active digit is flashing.
- ⇒ Acknowledge by . „LoAd“ is displayed.
- ⇒ Carefully place adjusting weight in the centre of the weighing plate. Wait for stability display, then press . „PASS“ appears
- ⇒ After the adjustment the balance will carry out a self-test. Remove adjusting weight **during** selftest, the appliance will return into weighing mode automatically. An adjusting error or incorrect adjusting weight will be indicated by the error message; repeat adjustment procedure.











9.2 Non-verifiable models:

- ⇒ Switch on balance Whilst balance is carrying out self-test (counts down from 99... to 00...)  and  press at the same time. "UnLoad" will be displayed, followed by flashing numeric value.

(Example)

- ⇒ Change by pressing the navigation keys (See manual chap. 8); select desired setting; currently enabled digit will be flashing.

(Example)

- ⇒ Confirm value by , "Load" will be displayed.

- ⇒ Place adjustment weight, stability display  appears

- ⇒ After the adjustment the balance will carry out a self-test. Remove adjusting weight **during** self test, balance will return into weighing mode automatically. In case of an adjustment error or incorrect adjusting weight the display will show an error message, repeat adjustment process.

9.3 Verification

General introduction:

According to EU directive 90/384/EEC balances must be verified if they are used as follows (legally controlled area):

- a) For commercial transactions if the price of goods is determined by weighing.
- b) For the production of medicines in pharmacies as well as for analyses in the medical and pharmaceutical laboratory.
- c) For official purposes.
- d) For manufacturing final packages.

In cases of doubt, please contact your local trade in standard.

Verification notes:

An EU Qualification Approval is in existence for verified weighing systems. If a balance is used where obligation to verify exists as described above, it must be verified and re-verified in regular intervals.

Reverification is carried out according to relevant national statutory regulations. The validity for verification of balances in Germany is e.g. 2 years.

The legal regulation of the country where the balance is used must be observed!



- Verification of the weighing system is invalid without the "seal".

Notes on verified balances

Possible seals: B urgent, and A or C

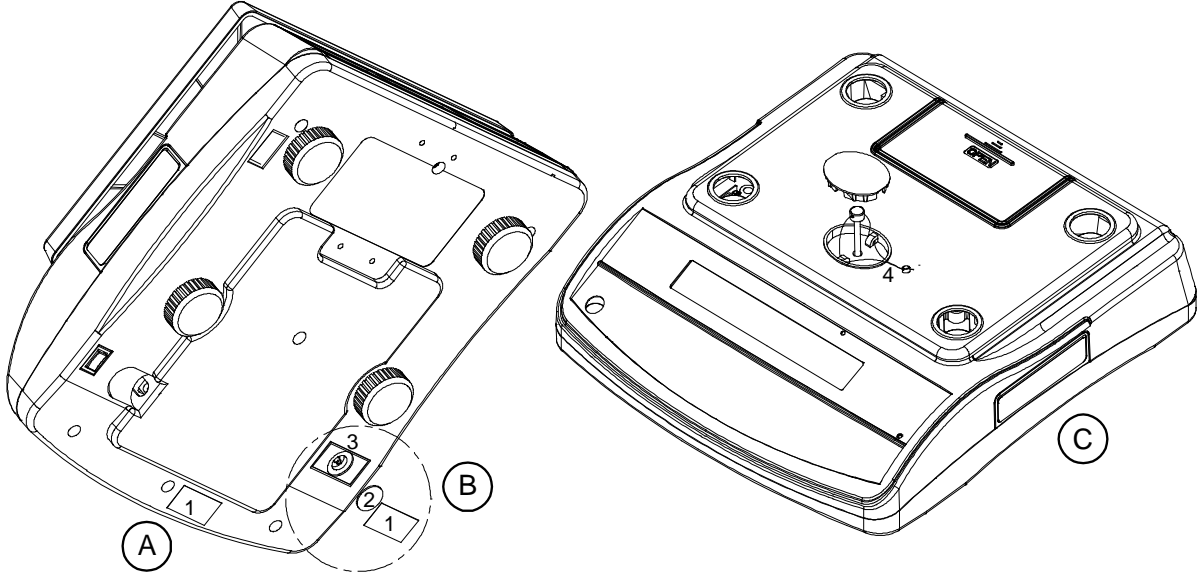

- 1. Seal of approval
- 2. Cover
- 3. Verification switch
- 4. Verification wire

English

9.4 Linearization (non-verified models only)

Linearity shows the greatest deviation of a weight display on the scale to the value of the respective test weight according to plus and minus over the entire weighing range.









If linearity deviation is discovered during a testing instrument control, you can improve this by means of linearization.

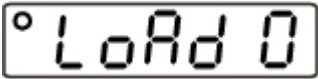

- Carrying out linearization is restricted to specialist staff possessing well acquainted with the workings of weighing scales.
- The test weights to be used must be adapted to the weighing scale's specifications; see chapter 2.4 "Testing instruments control".
- Observe stable environmental conditions. Stabilisation requires a certain warm-up time.
- After successful linearization you will have to carry out calibration; see chapter 2.4 "Testing instruments control"

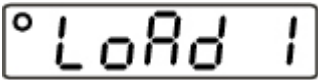
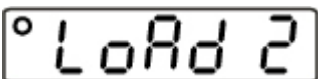
Tab. 1: Adjustment points

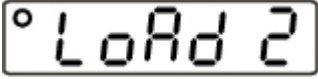
| Adjustment weight | GAB 6K0.05N | GAB 12K0.1N | GAB 30K0.2N |
|-------------------|-------------|-------------|-------------|
| 1. | 0 kg | 0 kg | 0 kg |
| 2. | 2 kg | 4 kg | 10 kg |
| 3. | 4 kg | 8 kg | 20 kg |
| 4. | 6 kg | 12 kg | 30 kg |

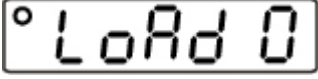
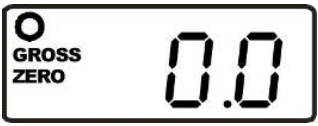
| Operation | Display |
|---|---|
| <p>How to carry out linearization:</p> <p>⇒ Switch on the balance and during the selftest press the  and the  button at the same time. „LoAd 0“ followed by LoAd 1“ will be displayed.</p> |    |
| <p>⇒ Place the second adjustment weight.</p> <p>⇒ After the apparition of the stability display, „LoAd 2“ will be displayed</p> |  |
| <p>⇒ Put on the third adjustment weight</p> <p>⇒ After the apparition of the stability display, „LoAd 3“ will be displayed</p> |  |
| <p>⇒ Put on the forth adjustment weight (max load)</p> <p>⇒ After the apparition of the stability display, „LoAd 2“ will be displayed</p> |  |
| <p>⇒ Third adjustment weight</p> <p>⇒ After the apparition of the stability display, „LoAd 1“ will be displayed</p> |  |
| <p>⇒ Second adjustment weight</p> <p>⇒ After the apparition of the stability display, „LoAd 0“ will be displayed</p> |  |
| <p>⇒ First adjustment weight (weighing plate empty)</p> <p>⇒ After successful linearization the balance automatically returns to weighing mode.</p> |  |

In case of an adjustment error or incorrect adjusting weight the display will show an error message; repeat linearization process.

10 Operation

10.1 Weighing

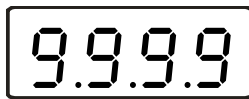

- ⇒ Turn on the scales by pressing the ON/OFF button underneath the scales on the right.
The balance will carry out a self-test. The balance is ready for weighing when the weight display „0.0“ appears.



- When required, the scales can be reset to zero at any time using .

Printout example:

N 0.500 kg

10.2 Weighing with tare



(Example)



- ⇒ Deposit weighing receptacles
⇒ After successful stop check press the  button.

The zero display and the symbol **NET** will appear.
The weight of the container is now internally saved.

- ⇒ When the weighing container is removed, its weight will be shown as a negative value.

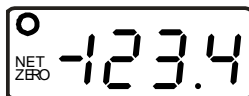

- ⇒ The taring process can be repeated any number of times, e.g. when adding several components for a mixture (adding). The limit is reached when the whole weighing range is exhausted.



- ⇒ To delete the tare value, remove load from weighing plate and press .

Printout example:

Net weight:

N 0.500 kg

10.3 Percent weighing

Percent weighing allows to display weight in percent, in relation to a reference weight.



⇒ Unload scales and set to zero



⇒ Put a reference weight on the weighing plate, which corresponds to 100%

(Example)

⇒ Press 



100.00 % will appear on the display

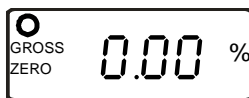

⇒ Remove the reference weight
The display will return to **0.00 %**

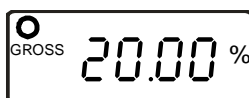

⇒ Place a sample
The display will show the percentage value of the sample in relation to the reference value.

⇒ To return to gram / kilo mode, press 

Printout example:

Percent:

G. 199.99%

10.4 Parts counting

Before the balance can count parts, it must know the average part weight (i.e. reference). Proceed by putting on a certain number of the parts to be counted. The balance determines the total weight and divides it by the number of parts (the so-called reference quantity). Counting is then carried out on the basis of the calculated average piece weight.



The higher the reference quantity the higher the counting exactness.



⇒ Place the reference quantity

(example)



⇒ Press , the scales will change to quantity counting mode
Reference quantity of 10, **P 10** will appear.

⇒ Reference quantities of 10, 20, 50, 100 and 200 can be set
by pressing .





⇒ Confirm by pressing 

(example)

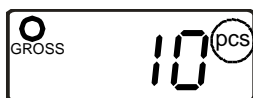
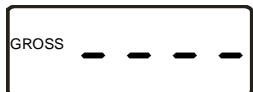
You will briefly see a line on the screen before the scales show the respective quantity



⇒ To change between reference weight, total weight and
quantity, press the  key.

⇒ To return to weighing mode, press the  key.

Printout example:

Parts counting:

| | | |
|----------|----------|----------------------|
| G. | 0.500 kg | Reference weight |
| 50 g/pcs | | Average parts weight |
| 10 pcs | | Number of parts |

10.5 Weighing with tolerance range

You can set an upper or lower limit when weighing with tolerance range and thus ensure that the weighed load remains exactly within the set limits.

Exceeding or dropping below the tolerance range is indicated by an audio sound or optical signal.

Audio signal:

The audio sound depends on the setting in menu block "BEEP" (See chap. 11 menu).



Options:

- 0 No audio sound during tolerance weighing
- 1 An acoustic signal sounds when load is within tolerance limits
- 2 An acoustic signal sounds when load is beyond tolerance limits

Optical signal:

The arrow symbols indicate whether load is within the two set limits.

The icons provide the following information:

| | | |
|---|-------|---|
|  | ——— 1 | 1. Goods to be weighed above tolerance limit |
|  | ——— 2 | 2. Goods to be weighed within tolerance range |
|  | ——— 3 | 3. Goods to be weighed below tolerance limit |

10.5.1 Traffic light function

When using a traffic light, the following can be displayed:

| | |
|-------------|--|
| red lamp | Goods to be weighed above tolerance limit |
| yellow lamp | Goods to be weighed below tolerance limit |
| green lamp | Goods to be weighed within tolerance range |

Settings:



⇒ Unload scales and set to zero



⇒ Press .
The left digit will be flashing and icon **HI** will be displayed

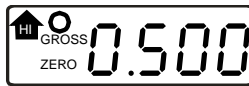

⇒ Enter upper limit by pressing and .

(Example)



⇒ Confirm upper limit by pressing .
The weighing scales will change to the prompt for entering the lower limit.



⇒ Enter lower limit by pressing and .

(Example)

⇒ Confirm lower limit by pressing .



The scales will change to zero display.



- To reset the enter value to zero, press .

Weighing with tolerance range

- ⇒ Tare when using a weighing container
- ⇒ Put on goods to be weighed, tolerance control is started



- The tolerance control is not active when the weight is under 20d.
- To finish tolerance weighing, set both limit to zero by pressing .

10.6 Manual totalizing

This function is used to add the individual weighing values to the summation memory and, if a printer is connected to provide a printout when the stability display appears and the  key pressed.

(For details how to set this function see chap. 11 menu “ACC on”)



(Example)

- ⇒ Place load A
Wait until stability display ○ appears



(Example)

- ⇒ Press  ACC 1 followed by the weighing value will appear and the weighing value will be saved to the summation memory and possibly printed.

- ⇒ Remove load A
Further loads can only be added after the display has returned to zero.



(Example)

- ⇒ Place load B
Wait until stability display appears ○



(Example)

- ⇒ Press  again
ACC 2, followed by the total weight will be displayed and the weighing value added to the summation memory and possibly printed.

- ⇒ Remove load B
Further loads can only be added after the display has returned to zero.





- ⇒ Add more weighed goods as described before.
Please note that the balance must be unloaded between the individual weighing procedures.
- ⇒ You can repeat this process until the capacity of the scales is exhausted.

Display of the saved weighing data:

⇒ With the weighing platform unloaded, press  and the number of weighing processes, followed by the total weight will be displayed for 2 sec and afterwards printed.

Delete weighing data:

⇒ With the weighing platform unloaded, press  followed by .
The data in the summation memory are deleted.

Printout example:

1st weighing:

| | |
|-----|----------|
| No. | 1 |
| G | 0.200 kg |
| C | 0.200 kg |

2. Weighing

| | |
|-----|----------|
| No. | 2 |
| G | 0.050 kg |
| C | 0.250 kg |

3. Weighing

| | |
|-----|----------|
| No. | 3 |
| G | 2.000 kg |
| C | 2.250 kg |

Number of weighings / total :

| | |
|-----|----------|
| No. | 3 |
| C | 2.250 kg |

10.7 Automatic adding-up

This function is used to automatically add individual weighing values to the summation memory and to receive a printout from a possibly connected optional printer.

For details on how to set this function see chap. 11 menu: „ACC on“)

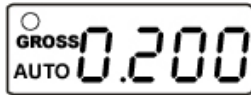

- ⇒ Place load A
After stabilisation control has taken place, you will hear an audio sound.
The weighing value will be saved to the summation memory.

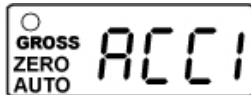

- ⇒ Remove load A
ACC 1, followed by the weighing value will be displayed and possibly printed.

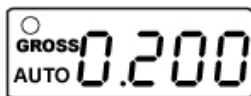

(Example)

Afterwards the weighing scales change to zero display.

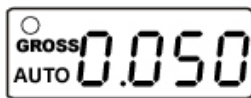
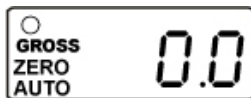

- ⇒ Place goods to be weighed B.
After the standstill control sounds a signal tone.
The weighing value is added into the total adding memory.

- ⇒ Remove load B

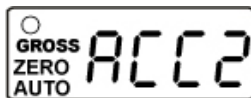

- ⇒ ACC 2, followed by the total weight will be displayed and possibly printed.

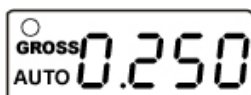

(Example)

Afterwards the weighing scales change to zero display.





- ⇒ Add more weighed goods as described before.
Please note that the balance must be unloaded between the individual weighing procedures.
- ⇒ You can repeat this process until the capacity of the scales is exhausted.

Display of the saved weighing data:

With the weighing platform unloaded, press  and the number of weighing processes, followed by the total weight will be displayed for 2 sec and afterwards printed.

Delete weighing data:

⇒ With the weighing platform unloaded, press  followed by .
The data in the summation memory are deleted.

Printout example:

1. Weighing :

No. 1
G 0.200 kg
C 0.200 kg

2. Weighing

No. 2
G 0.050 kg
C 0.250 kg

3. Weighing

No. 3
G 2.000 kg
C 2.250 kg

Number of weighings / total :

No. 3
C 2.250 kg









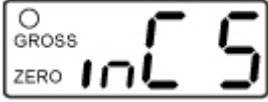

The two following items limit the totalizing process:

1. totalize max. 99 times
2. number of digits displayed









11 The menu

11.1 Navigation in the menu:

11.1.1 Non verifiable models

| | |
|--|--|
| <p>Call up menu</p>  | <p>In weighing mode press  and  at the same time The first menu item InC 5 will be displayed</p> |
| <p>Select menu block</p> | <p>⇒ With help of , the individual menu items can be selected one after the other.</p> |
| <p>Change settings</p> | <p>⇒ Switch into the available settings using .</p> |
| <p>Acknowledge setting / exit the menu</p> | <p>⇒ Either save by pressing  or cancel by pressing .</p> |
| <p>Return to weighing mode</p> | <p>⇒ Press  to exit menu.</p> |

11.1.2 Verifiable models

| | |
|--|---|
| <p>Call up menu</p>  | <p>⇒ Switch on balance While the balance carries out a self test, press  and  at the same time. The first menu item r dUAL is displayed</p> |
| <p>Select menu block</p> | <p>⇒ With help of , the individual menu items can be selected one after the other.</p> |
| <p>Change settings</p> | <p>⇒ Use the verification switch and the  button to switch over into the available settings.</p> |
| <p>Acknowledge setting / exit the menu</p> | <p>⇒ Either save by pressing  or cancel by pressing .</p> |
| <p>Return to weighing mode</p> | <p>⇒ Press  to exit menu.</p> |

11.2 Overview:

11.2.1 Non verifiable models

| Menu block Main menu | Menu item Submenu | Available settings / explanation |
|--|--|---|
| InC 5* | InC5... | not documented |
| | InC 10... | |
| | InC 20... | |
| | InC 50. | |
| EL Au....off* Background light | EL on | Background lighting on |
| | EL Au | Background light automatic off |
| | EL off | Background lighting off |
| Au off* Add-up mode | Au oFF | Manual add-up mode: Totalizing and editing to printer/PC by pressing  |
| | Au on | Automatic add-up mode: Automatic add-up and editing to printer/PC |
| | P Cont | Continuous data output |
| b 4800* Baud rate | Setting options for baud rate: 600/1200/2400/4800/9600 | |
| tP* Printout | tP | Output of weighing value |
| | LP50 | KERN-Label-Printer |
| ACC on* Add-up mode | ACC on | Add-up mode on |
| | ACC off | Add-up mode off |
| A2 2d* | A 0,5d | not documented |
| | A 1d | |
| | A 2d | |
| | A 4d | |
| Ut on* | not documented | |
| Ut off* | not documented | |

| | | |
|--|---|---|
| bBEEP1* Audio signal | 0 | No audio sound during tolerance weighing |
| | 1 | Audio sound when weight is within tolerance range |
| | 2 | Audio sound when weight is beyond tolerance range |
| SPd 15* Display speed | SPd 15 | not documented |
| | SPd 30 | |
| | SPd 60 | |
| oF 0* Auto off | Auto off after 0, 3, 5, 15, or 30 minutes | |
| return* | Return to weighing mode | |

* default setting

11.2.2 Verifiable models

| Menu block Main menu | Menu item Submenu | Available settings / explanation |
|-----------------------------------|--|---|
| r dUAL* | r 3000 | Weighing range |
| | r 6000 | |
| | r dUAL | |
| EL Au* Background illumination | EL on | Background lighting on |
| | EL Au | Background light automatic off |
| | EL off | Background lighting off |
| Au off* Data output | Au on | Automatic data output of stable weighing values |
| | Au off | No data output |
| | P Cont | Continuous data output of stable weighing values |
| b 9600* Baud rate | Setting options for baud rate: 600/1200/2400/4800/9600 | |
| ACC on* Add-up mode | ACC on | Add-up mode on |
| | ACC off | Add-up mode off |
| tP Printout | tP | Output of weighing value |
| | LP50 | KERN-Label-Printer |
| Ut on* | not documented | |
| Ut off* | not documented | |
| bEEP 0* Audio signal | 0 | No audio sound during tolerance weighing |
| | 1 | Audio sound when weight is within tolerance range |
| | 2 | Audio sound when weight is beyond tolerance range |
| SPd 15* Display speed | SPd 7.5 | not documented |
| | SPd 15 | |
| | SPd 30 | |
| | SPd 60 | |
| oF 0* Auto off | Auto off after 0, 3, 5, 15, or 30 minutes | |
| return* | Return to weighing mode | |

* default setting

12 Data output

12.1 RS232 interface

The RS 232 interface allows a bi-directional data exchange from the balance to external devices. This data exchange is asynchronous using ASCII - Code.

12.1.1 Technical data

- ASCII code
- 8 data bits
- Baud rate selectable at 600, 1200, 2400, 4800, 9600 bps
- Miniature plug-in necessary (9 pole D-Sub)
- No parity
- For operation with interface faultless operation is only ensured with the correct KERN – interface cable (max. 2m)

12.1.2 Pin allocation of balance output bushing:

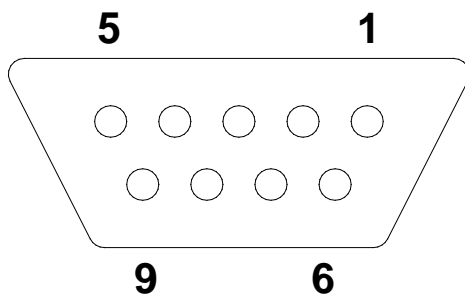

Pin 2: Output
Pin 3: Input, not used
Pin 5: Signal ground

12.1.3 Explanation of the data transfer

Example:

| | | | | | | | | | | | | | | |
|---------|---|---------|---|---------|----|----|----|----|----|----|----|---|------|------------|
| Header1 | , | Header2 | , | -/space | W1 | W2 | W3 | W4 | W5 | W6 | W7 | , | unit | terminator |
|---------|---|---------|---|---------|----|----|----|----|----|----|----|---|------|------------|

| | |
|------------|--|
| Header 1 | 2 byte, St or US, ST=weighing value stable, US=weighing value instable |
| Header 2 | 2 byte, G or N, G=gross weight, N= net weight |
| space | Blank |
| W1-W7 | Weight value with decimal position |
| Unit | 2 byte, kg or lb |
| Terminator | <CR> <LF> (CR=Carriage return) (LF= Line Feed) |

12.2 Remote control instructions

The remote control commands are sent from the remote control unit to the balance as ASCII code. After the balance having received the s/w/t commands, it will send the following data.

Take into account that the following remote control commands must be sent without a subsequent CR LF.

| | |
|------------------|--|
| T: tare | Taring |
| Z: zero | Zeroing |
| S: stable status | Sending stable weight values |
| W: | Sending stable or unstable weight values |
| P: | Sending the number of pieces (PCS) |

13 Service, maintenance, disposal

13.1 Cleaning

Before cleaning, disconnect the appliance from the operating voltage.

Please do not use aggressive cleaning agents (solvents or similar agents), but a cloth dampened with mild soap suds. Take care that the device is not penetrated by fluids and polish it with a dry soft cloth.

Loose residue sample/powder can be removed carefully with a brush or manual vacuum cleaner.

Spilled weighing goods must be removed immediately.

13.2 Service, maintenance





The appliance may only be opened by trained service technicians who are authorized by KERN.

Before opening, disconnect from power supply.

13.3 Disposal

Disposal of packaging and appliance must be carried out by operator according to valid national or regional law of the location where the appliance is used.

13.4 Error messages

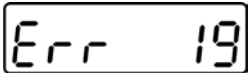
| Error message | Description | Possible causes |
|---|--|---|
|  | Zeroing range exceeded due to switching-on balance or pressing  (normally 4% max) | <ul style="list-style-type: none"> • Object on the weighing plate • Overload when zeroing • Improper adjustment • Damaged weighing cell • Damaged electronics |
|  | Keyboard error | <ul style="list-style-type: none"> • Improper operation of the balance |
|  | Value outside the A/D changer range | <ul style="list-style-type: none"> • Damaged weighing cell • Damaged electronics |
|  | Unable to initialise zero point | <ul style="list-style-type: none"> • Measuring cell defective / overloaded • Object on weighing pan / contact • Transport safety device has not been removed • Main board defective |

Should other error messages occur, switch balance off and then on again. If the error message remains inform manufacturer.

14 Instant help

In case of an error in the program process, briefly turn off the balance and disconnect from power supply. The weighing process must then be restarted from the beginning.

Help:

| Fault | Possible cause |
|--|--|
| The displayed weight does not glow. | <ul style="list-style-type: none">• The balance is not switched on.• Mains power supply interrupted (mains cable defective).• Power supply interrupted.• Rechargeable battery inserted incorrectly or empty |
| The displayed weight is permanently changing | <ul style="list-style-type: none">• Draught/air movement• Table/floor vibrations• Weighing plate has contact with other objects.• Electromagnetic fields / static charging (choose different location/switch off interfering device if possible) |
| The weighing result is obviously incorrect | <ul style="list-style-type: none">• The display of the balance is not at zero• Adjustment is no longer correct.• Great fluctuations in temperature.• Warm-up time was ignored.• Electromagnetic fields / static charging (choose different location/switch off interfering device if possible) |

Should other error messages occur, switch balance off and then on again. If the error message remains inform manufacturer.

15 Declaration of -Conformity

To view the current EC/EU Declaration of Conformity go to:

www.kern-sohn.com/ce

i The scope of delivery for verified weighing balances (= conformity-rated weighing balances) includes a Declaration of Conformity.

Importør:
Impex Produkter AS
Gamle Drammensvei 107
1363 Høvik
www.impex.no
info@impex.no
Tel.: 22 32 77 20