



Sauter GmbH

Ziegelei 1
D-72336 Balingen
e-mail: info@kern-sohn.com

Phone : +49-[0]7433- 9933-0
Fax: +49-[0]7433-9933-149
Internet: www.sauter.eu

Instruction Manual Multi-Mode Ultrasonic Material Thickness Gauge

SAUTER TN-EE

Version 2.0
04/2020
GB



PROFESSIONAL MEASURING

TN_EE-BA-e-2020



SAUTER TN-EE

V. 2.0 08/2020

Instruction Manual Multi-Mode Ultrasonic Material Thickness Gauge

Congratulations on the purchase of a multi-mode material thickness gauge from SAUTER. We hope you will enjoy your quality measuring instrument with its wide range of functions. Please do not hesitate to contact us if you have any questions, requests or suggestions.

Table of contents:

1.	General information	3
1.1	Technical data.....	3
1.2	Main functions	3
1.3	Measuring principle.....	4
1.4	Configuration	4
2.	Control panel and display layout	5
2.1	Explanation of the key symbols.....	6
3.	Preparation for commissioning	6
3.1	Selection of the sound generator	6
3.2	Conditions and preparations for surfaces.....	8
4.	Mode of operation	9
4.1	Switching on and off	9
4.2	Selecting the measuring mode	9
4.3	Zero Calibration	10
4.4	Calibration of the sound velocity.....	10
4.5	perform measurements.....	12
4.6	Scan mode (ultrasound image mode)	13
4.7	Changing the resolution	13
4.8	Changing the units	13
4.9	Storage Management	13
4.10	EL Backlight	15
4.11	Battery information	15
4.12	Automatic switch-off	15
4.13	Establishing the basic setting of the system (reset)	15
4.14	Connection to the computer	15
5.	Maintenance	16
6.	Transport and storage	16

1. General information

The Model TN-EE is a universal ultrasonic material thickness gauge. The device works according to the same measuring principle as SONAR gauges and is used to measure the thickness of various materials with a measuring accuracy of up to 0.1/0.01mm.

By simply switching from the operating mode 'pulse-echo' to 'echo-echo' (ignoring resist films or other films) the ultrasonic measuring instrument TN 60-0.01EE can be used universally.

1.1 Technical data

	TN 30-0.01EE	TN 60-0.01EE
Display	4.5 inch LCD display with backlight	
Measuring range (pulse-echo)	0.65~600mm (steel)	
Measuring range (Echo-Echo)	3~30mm	3~60mm
Sound velocity	1000~9999m/s	
Resolution	0.1mm/0.01mm Accuracy: $\pm 0,5$ % thickness +0,01mm,	
Memory	of up to 20 files (up to 99 measured values per file) with stored measured values	
Power supply	2x 1,5V AA batteries	
Communication	USB 1.1	
Ambient temperature	-20°C - 60°C	
max. air humidity	$\leq 90\%$	
Dimensions	150x74x32mm	
Weight	245g	

1.2 Main functions

1. Universal application: Operation in 'pulse-echo' and 'echo-echo' mode
2. Possibility to measure the thickness of various materials, such as metal, plastic, ceramics, composites, epoxy resins, glass and other materials with good ultrasonic conductivity
3. Special applications possible with various transducers, including thickness measurement of coarse-grained materials and at high temperature
4. Functions Sensor Zero, calibration of sound velocity
5. Function Two-point calibration
6. Single point mode and scan mode. The measurement results are requested seven times per second in single point mode and sixteen times per second in scan mode.
7. The thickness gauge has a status display for coupling connection
8. Measuring unit: metric/inch.
9. Battery indicator to indicate the remaining battery life
10. Automatic standby and shutdown function to conserve battery power
11. Software for processing stored measurement data with the computer

1.3 Measuring principle

The Ultrasonic Digital Material Thickness Gauge measures the thickness of a part or structure by accurately measuring the time taken for a short ultrasonic pulse to pass through the thickness of a material, controlled by a transducer, then reflected from the back or inner surface and returned to the transducer.

This measured two-way transmission time is divided by 2 (representing the outward and return paths), and then multiplied by the sound velocity of the corresponding material. The result is expressed by the following formula:

$$H = \frac{v \times t}{2}$$

H = Material thickness of the test object

V = sound velocity of the corresponding material

t = the measured transit time for the sound

1.4 Configuration

	No	Element	Quantity	Comment
Standard configuration	1	Unit- Main body	1	
	2	Sensor P5EE, 5 MHz, Ø 10 mm	1	
	3	Coupling means	1	
	4	Measuring instrument bag	1	
	5	Operating instructions	1	
	6	Alkaline batteries	2	AA
Optional configuration	7	Software for data storage (ATU-04)	1	
	8	Sensor 2.5 MHz, Ø 14 mm: ATU-US01	1	Only in pulse-echo mode
	9	Sensor 7 MHz, Ø 6 mm: ATU-US02	1	Only in pulse-echo mode
	10	Sensor 5 MHz, Ø 10 mm: ATU-US09	1	Only in pulse-echo mode
	11	Sensor 5 MHz, Ø 10 mm: ATU-US10, with 90° angle	1	Only in pulse-echo mode

2. Control panel and display layout

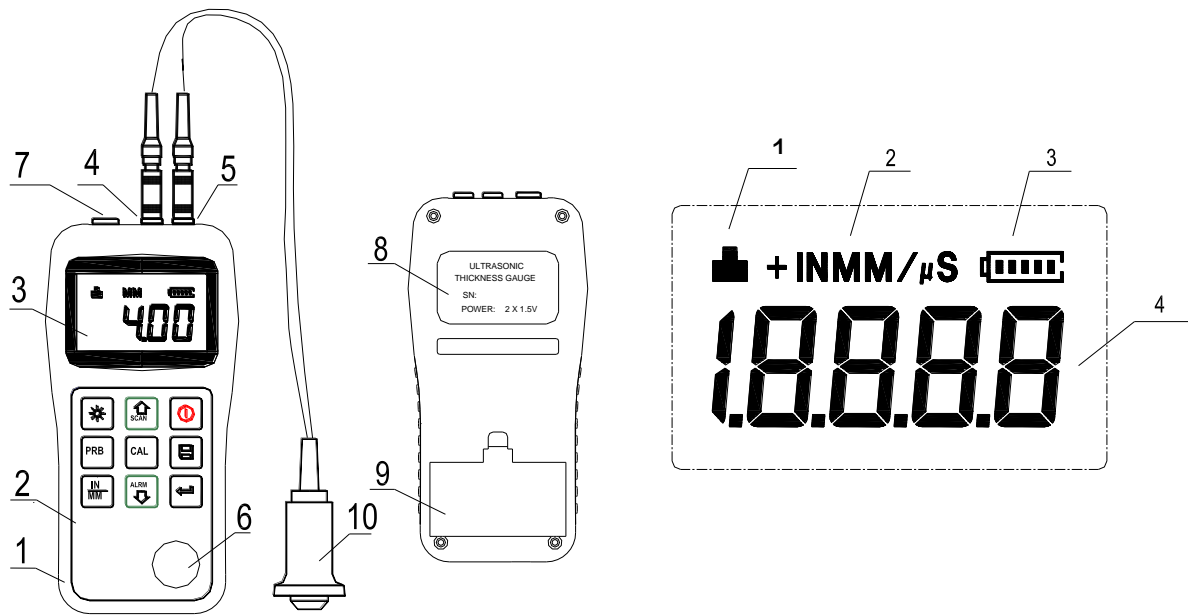









- 1 device main part
- 2 Keypad
- 3 LCD display
- 4 Pulse encoder socket
- 5 Radiation receiver socket
- 6 Zero plate
- 7 PC connection socket
- 8 Label (on the back)
- 9 Battery cover
- 10 US measuring probe

Explanation:

1. **Coupling status:** indicates the coupling status; this symbol must appear while measurements are being taken. If this is not the case, the instrument has problems obtaining stable measurements and it is very likely that deviations will occur.
2. **Unit:** mm or inches for the material thickness m/s or in/μ s for the speed of sound
3. **Battery indicator:** shows the remaining capacity of the batteries
4. **Information on the display:** The determined material thickness value and the speed of sound can be read off and indicates the current operation.

2.1 Explanation of the key symbols

	Switching on/off		Calibration Sound-speed
	Background lighting On/ Off		Enter key
	Button for Zero- position		Plus; scan mode On/ Off
	Button for Changing the units		Minus; pulse-echo switch u. Echo-Echo Mode
	Save data o. delete		

3. Preparation for commissioning

3.1 Selection of the sound generator

With this instrument a wide range of materials can be measured, from various metals to glass and plastics. For these different types of materials, different sounders, i.e. US measuring heads, are required. The correct transducer is crucial for a reliable measurement result. The following sections explain the important characteristics of the transducers and what should be considered when selecting a transducer for a specific test object.

In general terms, the best transducer for a test object should send sufficient ultrasonic energy into the material to be measured so that a strong, stable echo arrives at the instrument. Certain factors influence the strength of the ultrasound as it is transmitted. These can be read in the following:

The initial signal strength: The stronger a signal is from the beginning, the stronger the returning echo will be. The initial signal strength is mainly a factor of the size of the ultrasonic emitter in the transducer. A strong emitting surface will emit more energy into the material than a weak one. Consequently, a so-called "1/2 inch" US probe will emit a stronger signal than a "1/4 inch" US probe.

Absorption and scattering: When the ultrasound passes through any material, it is partially absorbed. In materials with a granular structure, the sound waves scatter. Both of these influences reduce the strength of the sound waves and thus the ability of the device to detect or record the returning echo. Sound waves with higher frequencies are more "swallowed" than those with lower frequencies.

So, it might seem, it would be better to use a low frequency probe in any case, but these are less alignable (bundled) than those with high frequencies. Consequently, a high-frequency transducer would be the better choice for detecting small depressions or impurities in the material.

Geometry of the transducer: The physical limits of the measurement environment sometimes determine the suitability of the transducer for a particular test object. Some sounders are simply too large to be used in a fixed environment. If the available surface area for contact with the transducer is limited, a transducer with a small contact area is required.

If a curved surface is measured, e.g. a drive cylinder wall, the contact surface of the sound generator must also be adapted to it.

Temperature of the material: If measurements are made on unusually hot surfaces, high-temperature sounders are used. These are built in such a way that they can be used at high temperatures for special materials and techniques without suffering damage. In addition, care must be taken when performing a "zero calibration" or "calibration with known material thickness" using a high temperature transducer.

The selection of a suitable sound generator is often a compromise between different influences and characteristics. Sometimes it is necessary to select several to try out sounders until the most suitable one for the test object is found.

The sound generator is the "end piece " of the measuring instrument. It transmits and receives ultrasonic waves, which the device uses to measure the thickness of the material to be examined. The transducer is connected to the gauge by an adapter cable and two coaxial connectors. When sounders are used, plugging in the connectors is simple: either the plug fits into the socket or into the instrument itself. The transducer must be used correctly to obtain accurate, reliable measurement results.

The following is a brief description of one of these, followed by instructions for use.



The upper figure shows the bottom view of a typical sound generator. The two half circles are visible, visibly divided in the middle. One of the semicircles directs the ultrasound into the material to be measured and the other directs the echo back to the transducer. When the transducer is placed on the material to be measured, it is located directly below the center of the area whose thickness is to be measured.

The picture below shows the top view of a sound generator.

It is pressed with the thumb or index finger from above on the sound generator to keep it exactly placed. Only moderate pressure is required, as its surface only needs to be positioned flat on the material to be measured.

Model	Frequency MHz	Φ mm	Measuring range	Lower limit	Comment
P5EE	5	10	P-E: 2~600 mm E-E: 3~30/60 mm	Φ20 mm×3,0 mm	Standard measurement

3.2 Conditions and preparations for surfaces

For any kind of ultrasonic measurement, the condition and roughness of the surface to be measured is of utmost importance. Rough, uneven surfaces can restrict the penetration of the ultrasonic waves through the material, resulting in unstable, incorrect measurement results. The surface to be measured should be clean and free of any substances, rust or verdigris. If this is the case, the transducer cannot be placed cleanly on the surface. Often a wire brush or scraper is helpful to clean the surface. In extreme cases, belt grinders or the like can be used. However, it is important to avoid gouging the surface, which prevents the sound generator from being placed cleanly. Extremely rough surfaces like siliceous cast iron are very difficult to measure. These types of surfaces behave like when light shines on frosted glass, the beam is scattered and sent in all directions. In addition, rough surfaces contribute to considerable wear and tear of the transducer, especially in situations where it is "scrubbed" over the surface. They should therefore be checked at a certain distance, especially at the first signs of unevenness on the contact surface. If it is worn down more on one side than the other, the sound waves can no longer penetrate vertically through the material surface of the test object. In this case, small irregularities in the material are difficult to measure because the sound beam is no longer exactly below the sound source.

4. Mode of operation

4.1 Switching on and off

The device is switched on  by pressing the key. After switching on, a short test of the display is first carried out by switching on all display segments. After 1s the current setting of the sound velocity and, if necessary, readiness for measurement are displayed.

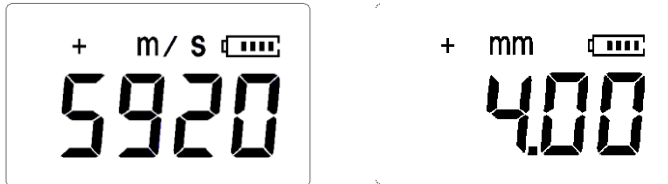

To switch off the device,  press the button again. Thanks to the built-in memory, all settings are permanently retained, even when the power is switched off. The device is also equipped with an automatic power-off function to save the batteries. If the unit is not operated for 5 minutes, it switches off automatically.

4.2 Selecting the measuring mode

It often happens that the thickness of pipes or containers is to be measured when used outside. Usually the paint layer or any other layer must be removed before the measurement. Otherwise, the certain error, caused by the thickness of the respective layer as well as the speed of sound, must be taken into account.





With the ultrasonic thickness gauge TN 60-0.01EE this measuring error does not occur, because it has a measuring mode 'Echo-Echo' developed for this purpose. The selection of the appropriate mode is very easy and is done by pressing a key. Afterwards, it is no longer necessary to remove the paint layer or any other layer.

To switch the instrument from 'Pulse-Echo' to 'Echo-Echo' measuring mode, simply  press the key.

4.3 Zero calibration

Important! The zero calibration function is only accessible in the 'Pulse-Echo' measuring mode.

To carry out the zero setting,  press the key. This is done in almost the same way as a mechanical micrometer is zeroed. If the instrument is not correctly zeroed, all measurements made will be incorrectly zeroed by this incorrect base value. When the instrument is zero-calibrated, a fixed error value is measured and automatically corrected for all subsequent measurements. The procedure is as follows:

1. The sound generator is plugged into the measuring instrument. It must be checked whether all plug connections are faultless. The contact surface of the sound generator should be clean and free of any foreign matter.
2. Press the  key to enter the zero mode.
3. Use the  and  keys to  select the sound generator which is currently in use. Please make sure that the correct sound generator is selected, otherwise measurement errors may occur.
4. A single drop of the ultrasound contact gel is now applied to the top of the round metal plate on the instrument.
5. The ultrasonic measuring head must be pressed onto the metal plate in such a way that it lies flat on the surface.
6. Then the transducer is lifted off the metal plate.

At this point, the instrument has successfully calculated the internal error factor and will compensate for it in all subsequent measurements. If a zero calibration is performed on the instrument, it will always use the sound velocity of the zero plate installed in the instrument, even if a different sound velocity value has been entered to make current measurements. Although the instrument retains the last zero calibration performed, it is generally recommended to perform it again when the instrument is turned back on. This is especially true if a different sound source is used. This is to ensure that the instrument has always been correctly zero-calibrated.

Press the key to  interrupt the current zero calibration and return to the measuring mode.

4.4 Calibration of the sound velocity

In order to be able to make exact measurements, this must be adjusted to the speed of sound of the corresponding material. Different materials have different sound velocities. If this is not done, all measurements will be faulty by a certain percentage.





Single point calibration is the simplest and most common procedure for calibrations that optimize linearity over long ranges (measuring ranges). **Two-point calibration** allows higher accuracy at shorter ranges by calculating the zero setting and the speed of sound.

Note: For **one-point and two-point calibrations**, paint or coating must be removed in advance. If this is not done, the calibration result will consist of a kind of "multi-

material sound velocity" and will certainly not be the same as the actual material to be measured.





4.4.1 Calibration with known material thickness

Note: This procedure requires a sample of the material to be measured, its exact thickness, which has been measured in some way before.

1. The zero setting is made.
2. The sample material is provided with coupling gel.
3. The US measuring probe is pressed onto the piece of material, making sure that it lies flat on the surface. A material thickness value is now shown on the display and the coupling symbol should appear.
4. As soon as a stable reading value is reached, the US measuring probe is lifted off again. If the thickness of the material just detected differs from the value that existed during the coupling, step 3) must be repeated.
5. The key is  pressed and thus the calibration mode is activated. The MM (or IN) symbol should start flashing.
6. With the and  keys you  can now adjust the required material thickness (that of the material pattern).
7. The key  is pressed again and the M/S (or IN/ μ S) should start flashing. The display will now show the sound velocity value previously calculated based on the material thickness.
8. To exit the calibration mode, press the key to  return to the measuring mode. From now on measurements can be made.

4.4.2 Calibration at known sound velocity

Note: For this procedure the sound velocity of the material to be measured must be known.







1. Press the key to activate  the calibration mode. The MM (or IN) symbol should start flashing.
2. Press this button repeatedly so that the M/S (or IN/ μ S) symbol also flashes.
3. Use the and  keys to change  the sound velocity value up or down until it corresponds to the sound velocity of the material to be measured. It is also possible to  switch between the preset, generally used velocities of sound with the key.
4. To exit the calibration mode,  press the key. From now on measurements can be made.

In order to obtain the most accurate measurement result possible, it is generally recommended to calibrate the measuring instrument with a material sample of known material thickness.

The material composition itself (and thus the speed of sound) often varies from one manufacturer to another. Calibration with a material sample of known thickness ensures that the instrument is adjusted as accurately as possible to the material to be measured.

4.4.3 Two-point calibration

This procedure assumes that the user has two known material thickness points of the test material and that these are representative for the measuring range.

1. The zero setting is made
2. Coupling agent is applied to the material sample.
3. The US measuring probe is placed on it (at the first or second calibration point) and the correct position of the US measuring head on the material sample is checked. The display should now show a (probably incorrect) measured value and the coupling symbol should appear.
4. As soon as a stable measured value is reached, the sound generator is lifted off. If the reading differs from that when the transducer was coupled, step 3 must be repeated.
5. The key  is pressed and the M/S (or IN/ μ S) should start flashing.
6. The  and  keys can now be used to correct the required material thickness on the display until it matches that of the material pattern.
7. The key  is pressed and the display shows 1OF2. Steps 3) to 6) are now repeated for the second calibration point.
8. The  key is pressed so that the M/S (or IN/ μ S) starts to flash. The instrument now displays the sound velocity value that it has calculated based on the material thickness value entered in step 6).
9. Press the key  again to exit the calibration mode. Measurement can now be started in the preprogrammed measuring range.

4.5 perform measurements

The meter always stores the last measured value until a new value is added.

For the sound generator to function properly, there must be no air bridges between its contact surface and the surface of the material to be measured. This is achieved with the ultrasonic gel, the "coupling agent". This liquid "couples" or transmits the ultrasonic waves from the transducer into the material and back again. Before the measurement, a little coupling agent should therefore be applied to the material surface to be measured. Even a single drop is sufficient.

Then the US measuring probe is carefully pressed firmly onto the material surface. The coupling symbol and a number appear in the display. When the instrument has been "properly adjusted" and the correct sound velocity has been determined, the number in the display shows the current material thickness measured directly under the sound source.

If the coupling indicator does not appear or the number on the display is questionable, first check that there is sufficient coupling agent at the point under the US probe and that it has been placed flat on the material. Sometimes it is necessary to try a different transducer for the material in question (diameter or frequency).

While the US measuring probe is in contact with the material to be measured, four measurements are taken per second. When it is lifted from the surface, the display shows the last measurement.

Note: Sometimes a thin film of the coupling agent is drawn between the US probe and the material surface when the probe is lifted off. In this case, it is possible that a measurement is made through this film, which then turns out to be larger or smaller than it should. This is obvious because if one measurement is taken while the US probe is still in place and the other when it has just been lifted off. In addition, when materials with thick paint or coating are used, they are measured instead rather than the intended material. Ultimately, the responsibility for the clean use of the gauge in connection with detecting these phenomena is withheld from the user.

4.6 Scan mode (ultrasound image mode)

While the instrument excels in single point measurements, it is sometimes desirable to examine a larger area to look for the thinnest point. This instrument has a scan mode feature that allows you to do just that.

In normal operation, four measurements are taken per second, which is very appropriate for single measurements. In scan mode this is ten measurements per second and the readings are shown on the display. While the transducer is in contact with the material to be measured, the instrument automatically searches for the smallest reading. The transducer can be "scrubbed" over the surface, because short interruptions of the signal are ignored. In the case of interruptions lasting longer than two seconds, the smallest measured value found is displayed. If the transducer is lifted, the smallest measured value found is also displayed.

When the scan mode is switched off, the single point measuring mode is automatically switched on.

The scan mode can be switched off as follows:

The key  is pressed to switch it on or off. The current state of the scan mode appears on the screen.

4.7 Change the resolution

The TN_EE series devices have two selectable screen resolutions, 0.1mm and 0.01mm.

If the key is pressed  after switching on, the resolution can be selected between "high" (high) and "low" (low).





4.8 Changing the units

Starting from the measuring mode, the unit can be changed by pressing  the key and selecting between mm (metric) and inch (English).

4.9 Storage management





4.9.1 Saving a meter reading

The measured values can be stored in the device with 20 files (F00-F19). For each file there are at least 100 registers (material thickness values) that can be stored. If the key  is pressed after a new reading is displayed, the measured material thickness is stored in the current, running file. If you want to change the file in which the measured values are stored, proceed as follows:

1. Press the key to  activate the data collection function and to read the current file name and the total number of all data records in the file.
2. Use the and  keys to  set the desired file as the current one.
3.  This program can be exited at any time with the key.









4.9.2 Delete the contents of a specific file

It is also possible to completely delete the contents of a file, which allows the user to create a new list of measurements in memory location L00. The procedure is as follows:

1. Press the key to  activate the measurement data acquisition function and to read the current file name and the total number of all data sets in the file.
2. With the and  key you  can scroll back and forth in the file until the corresponding file is found.
3. At the desired file, press  the button and the contents will be deleted automatically. The display shows the "-DEL" symbol.
4. The key  can be used at any time to exit the data acquisition program and return to the measuring mode.

4.9.3 Entering/deleting stored data records



This function allows the user to enter or delete a data record in a desired, previously saved file. The following steps have to be taken:

1. Press the key to  activate the measurement data acquisition function and to read the current file name and the total number of all data sets in the file.
2. Use the and  keys to  highlight the desired file.
3. Press the key to  open the desired file and the display shows the current data set (e.g. L012) and its contents.
4. Use the and  keys to  select the desired data record.
5. Press the key  at the desired position. It is now automatically deleted and the display shows "-DEL".
6.  This program can be exited at any time with the key and the measuring mode can be returned to.

4.10 EL Backlight

This allows it to be used in a dark environment. The key  is used to activate and deactivate the backlight once the meter has been turned on. Since the EL light consumes a lot of power, it should only be switched on when needed.

4.11 Battery information

Two AA alkaline batteries are required as energy source. After several hours of use, the display will show the symbol . The larger the black portion in the symbol, the fuller the battery is. When the battery capacity is exhausted, the following symbol appears  and starts flashing. The batteries should now be replaced.

When changing the polarity must be observed.

If the device is not used for a longer period of time, the batteries should be removed.

4.12 Automatic switch-off

The device has an automatic switch-off function to save the batteries. If no key is pressed for more than 5 minutes, the unit switches off automatically.

It also switches off when there is insufficient battery voltage and the battery is almost exhausted.

4.13 Establishing the basic setting of the system (reset)

The key  is pressed during power-up to restore the factory settings. All memory data is also deleted. This procedure can be helpful if the parameter in the meter has become unusable.

4.14 Connection to the computer

The device is equipped with a USB port. With an additional cable the device can be connected to the computer or to an external storage medium. The measurement data stored in the instrument can be transferred to the computer via the USB connection. For detailed information on the communication software and its application, please refer to the respective software operating manual.

5. Maintenance

If you experience any unusual problems with your US thickness gauge, please do not repair, replace or disassemble it at your own risk. In such a case, please contact us by e-mail or telephone to discuss the further procedure with the service department. We will then carry out the maintenance as soon as possible.

6. Transport and storage

The measuring instrument must not be exposed to vibrations, strong magnetic fields, decomposing media or dust and must not be subjected to rough handling. It should be stored at normal temperature.

Appendix A Remarks on application

The measurement of tubes and hose material

If a piece of pipe is measured to determine the thickness of the pipe wall, the positioning of the transducer is important. If the diameter of the pipe is greater than 4 inches, the position of the transducer on the pipe should be such that the incision on the contact surface is perpendicular to the long axis of the pipe.

For smaller pipe diameters, two measurements should be made at the same location, one with the incision on the contact surface perpendicular to the long axis and the other parallel to it. The smaller of these two measurements is then taken as the exact measurement of this point.



Perpendicular

Parallel

Measuring coated materials

Coated materials are special because their density (and therefore the speed of sound) can vary considerably from one piece to another.

Even through a single surface, noticeable differences in the speed of sound can be detected. The only way to obtain an accurate measurement result is to first perform a calibration on a material sample of known thickness. Ideally, this should be from the same piece as the material to be measured, at least from the same production series. With the help of the "pre-calibration" the deviations are reduced to a minimum.

An additional important factor when measuring coated materials is that any trapped air gap causes premature reflection of the ultrasonic beam. This is noticeable in a sudden decrease of the material thickness. While on the one hand this prevents the exact measurement of the total material thickness, on the other hand the user is positively alerted to air gaps in the coating.

Measurement over paint layers or over any other layers

The possibility of measuring over paint layer or over any other layers is an exceptional function of the device. It is also very important because the speed of sound propagation in the varnish layer/other layer differs from the speed of sound propagation in the particular material for which the thickness measurement is to be made. A good

example of this is a pipe made of mild steel with a layer about 0.6 mm thick. The speed of sound propagation for the pipe is 5920 m/s, and for the paint layer 2300 m/s. If the gauge is set to measure the thickness of a mild steel pipe and then the measurement is made over both materials, the thickness of the layer will be 2.5 times greater than it actually is due to differences in the speed of sound propagation. Such an error can be avoided by selecting the 'Echo-Echo' measurement mode intended for measurement under such circumstances. In this measurement mode, the thickness of the paint coat/other coat is completely ignored and the measurement is concentrated on steel only.

Material suitability

Ultrasonic material thickness measurements are based on the fact that a sound is sent through the material to be measured. Not all materials are suitable for this. Ultrasonic measurement can be applied practically to a wide range of materials including metals, plastics and glass. Difficult materials include some cast materials, concrete, wood, fiberglass and some rubber.

Coupling means

All ultrasonic applications require a medium to transmit the sound from the transducer to the test material. Typically this is a very viscous medium. Ultrasound cannot be efficiently transmitted through air.

A variety of coupling means is used. For most applications propylene glycol should be used. Glycerine is recommended for difficult applications, as maximum sound transmission strength is required. However, glycerine can cause corrosion due to water absorption in some metals.

Other coupling agents for measurements at normal temperatures may include water, various oils or greases, gels and silicone fluids. High temperature measurements require special high temperature coupling agents.

A characteristic of ultrasonic measurement is that the instrument uses the second rather than the first echo from the rear surface of the material to be measured when in standard pulse-echo mode. This results in a reading that is **twice** as large as it should be.

The responsibility for the appropriate use of the measuring instrument and the detection of these phenomena lies exclusively with the user himself.

Note:

To view the CE declaration, please click on the following link:

<https://www.kern-sohn.com/shop/de/DOWNLOADS/>