

Leica DISTO™ with Bluetooth Smart usage
on
Android 4.3 or higher



V 1.1

April 2014

- when it has to be **right**

Leica
Geosystems

Content

- Leica DISTO™ devices
- Bluetooth compatibility
- Leica DISTO™ Bluetooth Smart
- Leica DISTO™ sketch for Android

The Leica DISTO™ devices with Bluetooth®



Leica DISTO™ D110
Bluetooth® Smart

→ Requires **Bluetooth® 4.0**



Leica DISTO™ D3a BT (D330i)
Bluetooth® 2.1

→ Requires **SPP** support



Leica DISTO™ D8
Bluetooth® 2.1

→ Requires **SPP** support



Leica DISTO™ D510
Bluetooth® Smart

→ Requires **Bluetooth® 4.0**



Leica DISTO™ D810 touch
Bluetooth® Smart





























→ Requires **Bluetooth® 4.0**



- when it has to be **right**

Leica
Geosystems

Overview DISTO™ compatibility

		Windows 7 	Windows 8.1 	Windows Mobile 6.5	Android 2.3.3 	Android 4.3 	iOS 
Leica DISTO™ D110 Bluetooth® 4.0		-	Leica DISTO™ transfer  www.disto.com	-	-	Leica DISTO™ transfer BLE Leica DISTO™ sketch 	Leica DISTO™ sketch 
Leica DISTO™ D3a BT Bluetooth® 2.1		Leica DISTO™ transfer  www.disto.com	Leica DISTO™ transfer  www.disto.com	Leica DISTO™ transfer PPC  www.disto.com	Leica DISTO™ transfer Leica DISTO™ sketch 	Leica DISTO™ transfer Leica DISTO™ sketch 	-
Leica DISTO™ D8 Bluetooth® 2.1		Leica DISTO™ transfer  www.disto.com	Leica DISTO™ transfer  www.disto.com	Leica DISTO™ transfer PPC  www.disto.com	Leica DISTO™ transfer Leica DISTO™ sketch 	Leica DISTO™ transfer Leica DISTO™ sketch 	-
Leica DISTO™ D510 Bluetooth® 4.0		-	Leica DISTO™ transfer  www.disto.com	-	-	Leica DISTO™ transfer BLE Leica DISTO™ sketch 	Leica DISTO™ sketch 
Leica DISTO™ D810 touch Bluetooth® 4.0		-	Leica DISTO™ transfer Keypad mode *)  www.disto.com	-	-	Leica DISTO™ transfer BLE Leica DISTO™ sketch 	Leica DISTO™ sketch Keypad Mode *) 

*) DISTO™ connects as a keyboard and sends data right to cursor position in any application or software

- when it has to be **right**



Prolog

This presentation should provide further advice on how to use the Leica DISTO™ with Bluetooth® Smart. Also the corresponding Apps for Android are described in this document.

Leica DISTO™ Bluetooth Smart



Getting started

- when it has to be **right**

Leica
Geosystems

General

Bluetooth® Smart

- Bluetooth® Smart is compatible with Bluetooth® 4.0 or Bluetooth® Smart Ready devices
- Bluetooth® Smart has very low power consumption why it is by default switched on

Leica DISTO™ D110

Bluetooth® Smart

- The Bluetooth® can be switched off and on at the Leica DISTO™ D110
- The Leica DISTO™ D110 only supports the connection to iOS or Android 4.3 Apps



Press for 2 sec. to switch
Bluetooth® on or off

- when it has to be **right**

Leica
Geosystems

Leica DISTO™ D510

Bluetooth® Smart

- The Bluetooth® can be switched off in the Settings of the Leica DISTO™ D510
- The Leica DISTO™ D510 only supports the connection to iOS or Android 4.3 Apps



Press '=' to switch on or off

- when it has to be **right**

Leica DISTO™ D810 touch Bluetooth® Smart

- The Bluetooth® can be switched off in the Settings of the Leica DISTO™ D810 touch



Leica DISTO™ D810 touch Bluetooth® Smart

- The Leica DISTO™ D810 touch provides 3 different modes for use with Bluetooth®

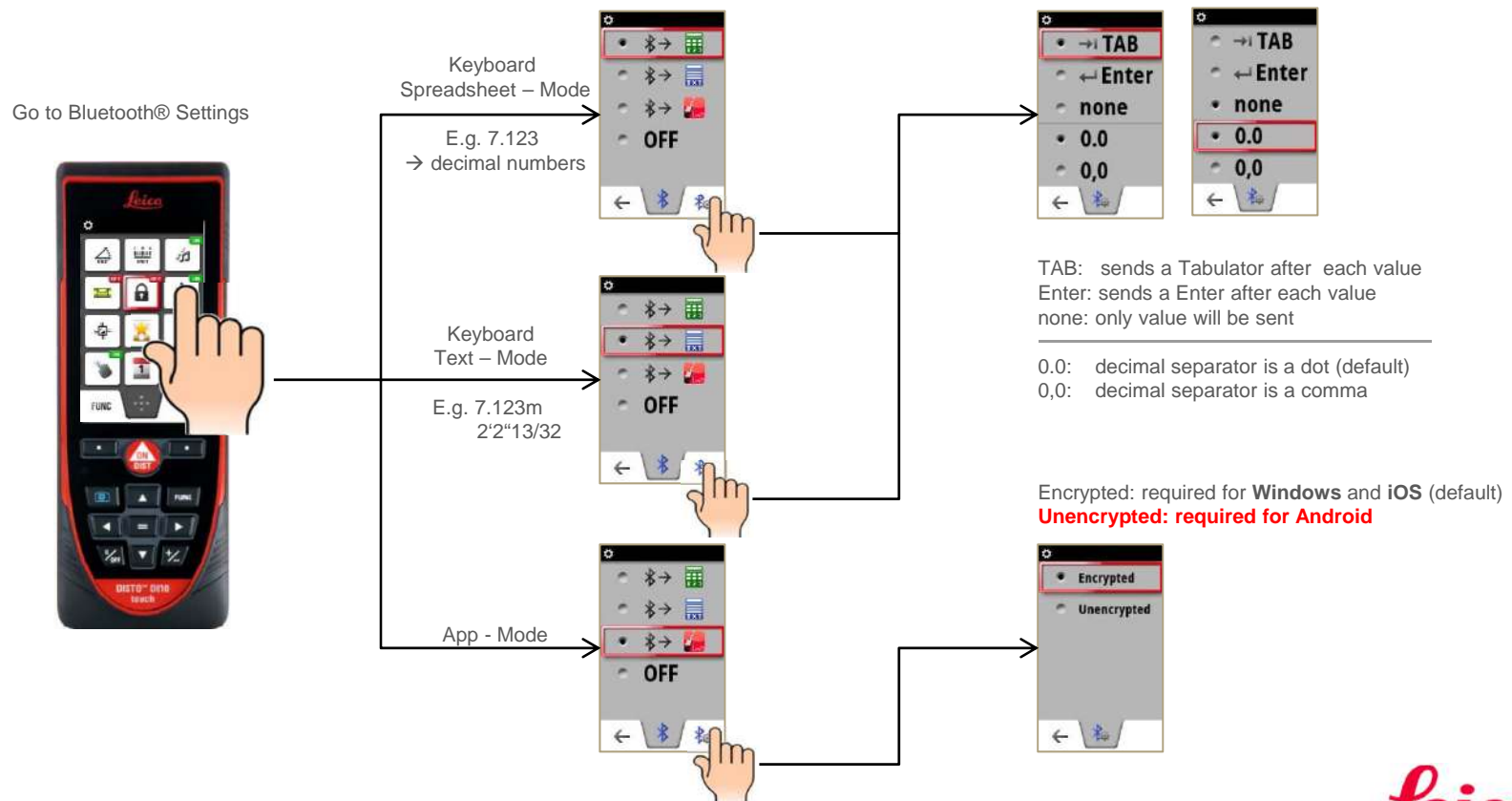

- when it has to be **right**



Leica DISTO™ sketch

Android 4.3 or higher 

Getting started

- when it has to be **right**

Leica
Geosystems

Leica DISTO™ sketch for Android 4.3 or higher

Start App

- When using with Leica DISTO™ D810 touch we are recommending to use the App mode for Bluetooth®
- When using with Leica DISTO™ D810 touch it is required to set the Leica DISTO™ device Bluetooth® to unencrypted mode first. Otherwise the device will connect but it will not transfer measurement values!
This is not required for the Leica DISTO™ D510 or D110.



Please
Note

This App works with Leica DISTO™ D3a BT (D330i), D8, D110, D510 and D810 touch

- when it has to be right

Leica
Geosystems

Leica DISTO™ sketch for Android 4.3 or higher

Start App

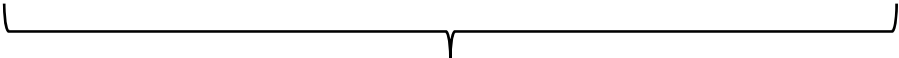

Tutorial

- when it has to be right



Leica DISTO™ sketch for Android 4.3 or higher

Start App – Connect Bluetooth®

Press if you want to start Scan for devices again

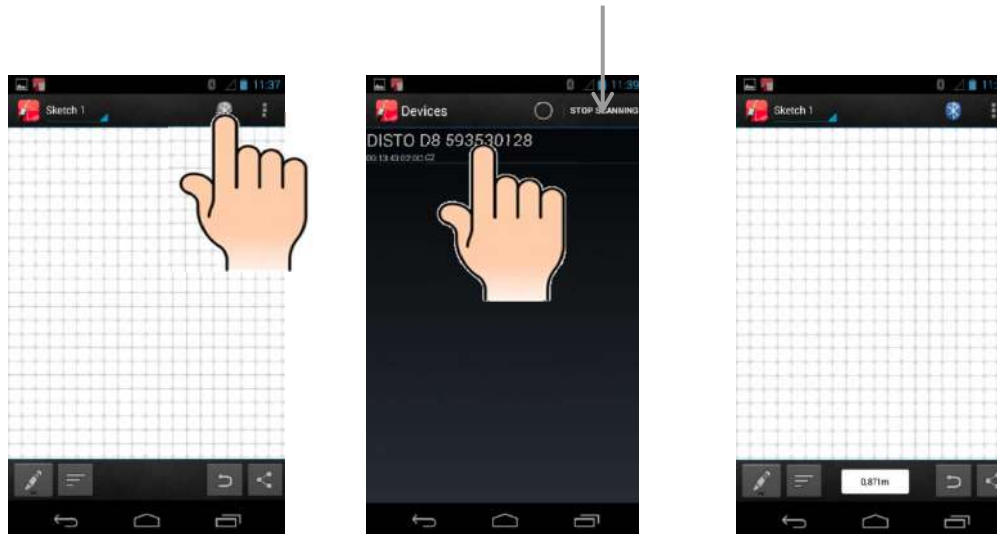

Leica DISTO™ sketch for Android 4.3 or higher

Sketch layout Overview

Add new sketch or photograph →

Connect/disconnect Bluetooth® →

Start Menu for Tutorial, Reset App →

- Tutorial
- Reset App
- Acknowledgement

Draw new line →

Show list of results (table) →

Value from DISTO™ →

Undo →

Export file to library, csv for table and pdf for sketch →

- CSV
- PDF

Name	Length	IncIn.	Description
Line 1	0,505m		
Line 2	0,505m		
Line 3	0,505m		
Line 4	0,505m		
Line 5	0,505m		
Line 6	0,505m		
Line 7	0,505m		
Line 8	0,505m		
Line 9	0,505m		
Line 10	0,505m		

- when it has to be **right**



Leica DISTO™ sketch for Android 4.3 or higher

Create new sketch

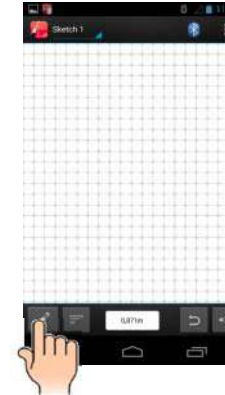
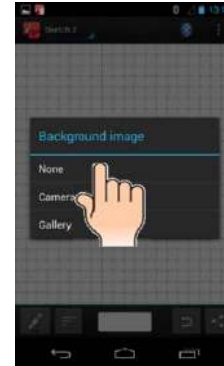
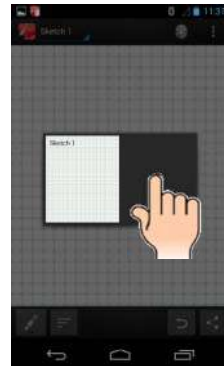
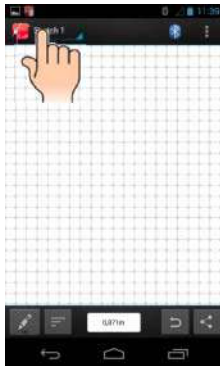

Enter new name if required

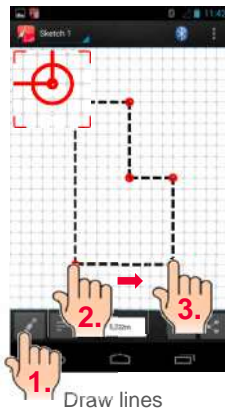

1. Draw lines

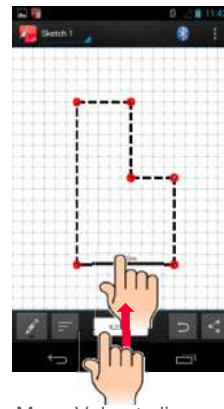

Move Value to line

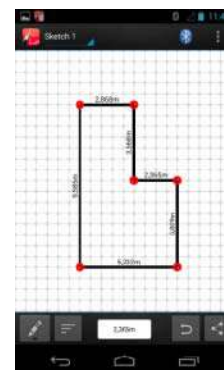

Transfer area, volume or a slope

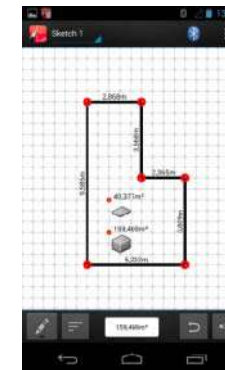

Please Note

Auto-scale not available for this App version

- when it has to be right

Leica
Geosystems

Leica DISTO™ sketch for Android 4.3 or higher

Changing sketch name or deleting sketch

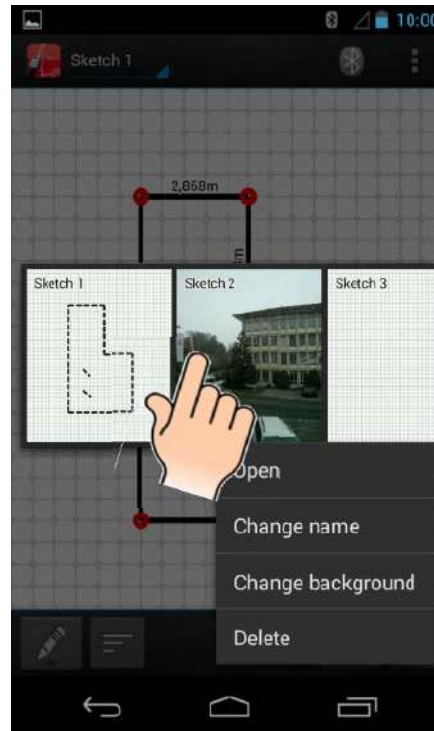

Leica DISTO™ sketch for Android 4.3 or higher

Create new sketch with photo

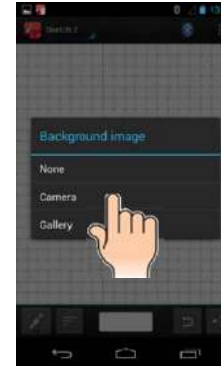
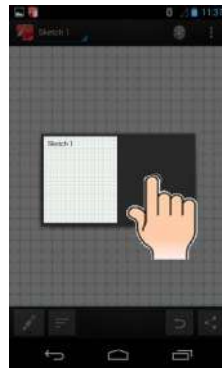
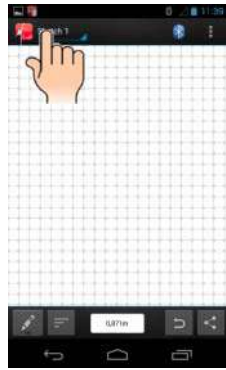

Leica DISTO™ sketch for Android 4.3 or higher

Good to know

- The Leica DISTO™ device only sends the currently measured value. To send a result from the main line of the DISTO™ press the „=„ key on the D810 touch or D510. For the D110 press the Bluetooth® key to send a result from the main line.



Press short to send the measurement value from the main line of the display (e.g. area)

- To send a value using a D3a BT or D8 with Bluetooth® 2.1 you need to press the Bluetooth® key
- If you like to transfer distance measurement values including the inclination you need to switch on the Level option in the Setting of your Leica DISTO™ device.



Leica DISTO™ D3a BT (D330i)

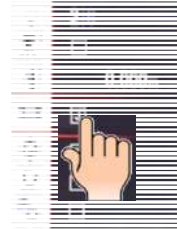

Leica DISTO™ D8



Leica DISTO™ D510 or D810 touch

- when it has to be right

Leica
Geosystems



Leica DISTO™ transfer

Android 4.3 or higher 

Getting started

- when it has to be **right**

Leica
Geosystems

Leica DISTO™ transfer for Android 4.3 or higher

Start App

- When using with Leica DISTO™ D810 touch we are recommending to use the App mode for Bluetooth®
- When using with Leica DISTO™ D810 touch it is required to set the Leica DISTO™ device Bluetooth® to unencrypted mode first. Otherwise the device will connect but it will not transfer measurement values!
This is not required for the Leica DISTO™ D510 or D110.



Please
Note

This App works with Leica DISTO™ D3a BT (D330i), D8, D110, D510 and D810 touch.
A version of this App is available for older Android versions as well but this does not support Bluetooth® smart

- when it has to be **right**

Leica
Geosystems

Leica DISTO™ transfer for Android 4.3 or higher

Start App – Connect Bluetooth®

Press if you want to start Scan for devices again



Press Menu to get pop-up

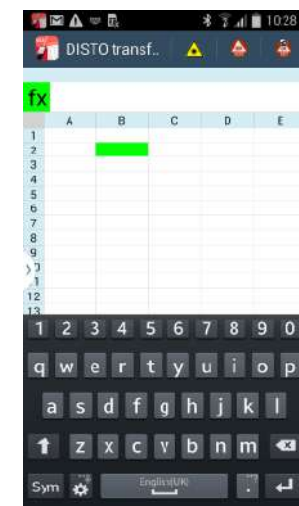
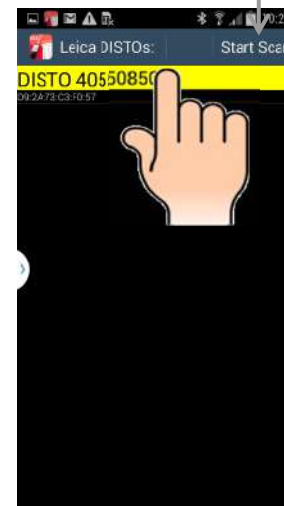

- when it has to be right

Leica DISTO™ transfer for Android 4.3 or higher

Transfer layout Overview

Shows location of File → /storage/emulated/0/Disto_20140415T104411.xls; DISTO_40550850

Text field for entering numbers or formulas → Es =A1+A2

Switch Laser of DISTO™ on/off *)

Start Distance Measurement on DISTO™ *)

Start Distance and Tilt Measurement on DISTO™ *)

*) Not possible for DISTO™ D510

Enabling confirmation Beep → Measure Beep

Enabling start screen → Show Splash Screen

Enable to search Excel files only / Disable to search with file manager → Search Excel Files

Enable to get data with units (e.g. 1,234m) → Units

Jump to next row after data received → Enter

Jump to next column after data received → Tabulator

Choose to convert metric data to cm or mm → Metric Data

Choose data format for feet and inch → Imperial Data

Enable to store data in clipboard to paste into any app (if transfer is running in background) → Send to Clipboard

Start file managing

Exit to close program, otherwise it continues working in the background

- when it has to be right

	A	B	C	D	E
1	1.352				
2	1.346				
3	7.424				
4	7.415				
5					
6					
7					
8					
9					
10					
11					
12					
13					
14					
15					
16					
17					
18					
19					
20					
21					
22					
23					
24					
25					