

Instruction Manual

HI 9829 Multiparameter Meter

With available GPS,
logging probe, turbidity
and ion measurements



Dear Customer,

Thank you for choosing a HANNA instruments® product.

Please read this instruction manual carefully before using the instrument.

It will provide you with the necessary information for correct use of the instrument, as well as its versatility.

If you need additional technical information, do not hesitate to e-mail us at **tech@hannainst.com** or visit our website www.hannainst.com for our worldwide contact list.

This instrument is in compliance with the CE directives.

HANNA instruments® reserves the right to modify the design, construction and appearance of its products without advance notice.

TABLE OF CONTENTS

CHAPTER 1 - INTRODUCTION

1.1 Preliminary Examination	6
1.2 Model Identification	6
1.3 General Description	6
1.4 Display and Keypad Description	8

CHAPTER 2 - QUICK START

2.1 Sensor and Probe Installation	9
2.2 Basic Operation	10
2.3 Help Function	11

CHAPTER 3 - SPECIFICATIONS

3.1 System Specifications	12
3.2 Probe Specifications	17
3.3 Sensor Specifications	18

CHAPTER 4 - PROBE INSTALLATION

4.1 Sensor Descriptions	19
4.2 Sensor Preparation/Activation	21
4.3 Sensor Installation	23

CHAPTER 5 - INITIALIZATION AND MEASUREMENT

5.1 Battery Installation	25
5.2 Meter Initialization	27
5.3 Measurement Mode	28
5.4 Setup Menu Structure	29

CHAPTER 6 - PARAMETER SETUP MENU

6.1 Select Parameters	30
6.2 Parameter Units	30
6.3 Parameter Coefficients	32
6.4 Averaging	33
6.5 Turbidity Averaging	33

CHAPTER 7 - CALIBRATION MODE

7.1 Quick Calibration	35
7.2 pH Calibration	37
7.3 ISE Calibration	40

7.4 ORP Calibration	41
7.5 Dissolved Oxygen Calibration	42
7.6 Conductivity Calibration	44
7.7 Turbidity Calibration	48
7.8 Temperature Calibration	50
7.9 Atmospheric Pressure Calibration	50
CHAPTER 8 - SYSTEM SETUP	
8.1 Meter Setup	52
8.2 Probe Setup	55
CHAPTER 9 - GPS MENU (optional)	56
CHAPTER 10 - STATUS	
10.1 Meter Status	58
10.2 Probe Status	58
10.3 GLP Data	59
CHAPTER 11 - LOGGING MODE	63
11.1 Logging menu structure	65
11.2 Logging on Meter	65
11.3 Probe Log	67
11.4 Log Recall	68
11.5 Log Notes	70
CHAPTER 12 - PC CONNECTION	
12.1 Software Installation	73
12.2 Meter to PC Connection	73
12.3 Probe to PC Connection	75
CHAPTER 13 - TROUBLESHOOTING / ERROR MESSAGES	77
APPENDIX	
A - PROBE MAINTENANCE	80
B - PROBE DEPLOYMENT	83
C - ISE INFORMATION	85
D - ACCESSORIES	91
E - WARRANTY	97

Chapter 1 - INTRODUCTION

1.1 PRELIMINARY EXAMINATION

Remove the instrument from the packing material and examine it carefully to make sure that no damage has occurred during shipping. If there is any damage, notify your Dealer or the nearest HANNA Customer Service Center immediately.

Note Save all packing materials until you are sure that the instrument functions correctly. Any damaged or defective items must be returned in their original packing material with the supplied accessories.

1.2 MODEL IDENTIFICATION

Meter: There are two models for the meter:

HI 9829: Portable multiparameter meter

HI 98290: Portable multiparameter meter with GPS

Probe: There are two base models of multiparameter probes:

HI 7609829: Standard multiparameter probe

HI 7629829: Multiparameter probe with autonomous logging capability

All meters and probes are fully compatible with each other, and all available measurement sensors can be used on both probe models.

Different combinations of meters, probes, sensors and accessories can be ordered either in predefined configurations or individually. See Appendix D for ordering configurations.

For example, ordering codes of probes follow:

HI 7609829/X is a HI 7609829 probe with X meter cable for pH/pH+ORP/ISE, D.O., EC, temperature sensors with a short probe shield

HI 7619829/X is a HI 7609829 probe with X meter cable for pH/pH+ORP/ISE, D.O., EC+turbidity, temperature sensors with a long probe shield

HI 7629829/X is a HI 7629829 logging probe with X meter cable for pH/pH+ORP/ISE, D.O., EC, temperature sensors with a short probe shield

HI 7639829/X is a HI 7629829 logging probe with X meter cable for pH/pH+ORP/ISE, D.O., EC+turbidity, temperature sensors with a long probe shield

1.3 GENERAL DESCRIPTION

HI 9829 is a portable logging multiparameter system that monitors up to 14 different water quality parameters (7 measured, 7 calculated).

The microprocessor-based intelligent multisensor probe allows measurement of many water quality parameters such as pH, ORP, turbidity, dissolved oxygen,

conductivity, chloride, nitrate, ammonium and temperature with data logging. The system is easy to setup and easy to use.

The **HI 98290** with GPS option has a built-in 12 channel GPS receiver and antenna that guarantees a position accuracy of 10 m (30 ft).

Measurements from specific locations are tracked with detailed coordinate information that can be viewed immediately on the display.

GPS information can be transferred to a PC using HANNA's **HI 929829** software. GPS information can also be viewed using a GPS mapping software such as Google™ Maps. Clicking on visited locations using a mapping software displays the measurement information.

All **HI 9829** are equipped with Fast Tracker™ an invaluable tool for associating measurements with their locations. HANNA's exclusive Fast Tracker™—T.I.S. (Tag ID System) uses iButton®s that can be installed at any number of sampling sites. The **HI 9829** features a graphic, backlit display that automatically sizes the digits to fit the screen with on-screen graphing capability. Each parameter is fully configurable.

HI 9829 was designed to withstand harsh environments and is the ideal solution for field measurements of lakes, rivers and sea.

The meter meets IP67 standards (30 minute immersion at a depth of 1 m) and the multisensor probe meets IP68 standards (continuous immersion in water).

Settings and logged data can be protected with a passcode to avoid unauthorized modifications and context-sensitive help is always available.

Main features of the **HI 9829** system:

- Rugged meter and probe
- Easy to use
- Measure up to 16 parameters and display of up to 12 parameters
- Tracking of measurement locations with GPS (optional)
- Waterproof protection (IP67 for the meter and IP68 for the probe)
- Exclusive Fast Tracker™—T.I.S. (Tag ID System)
- Graphic LCD with backlight
- Built-in barometer for D.O. concentration compensation
- Quick calibration feature
- Measurement check to eliminate any erroneous readings
- Autorecognition of probe and sensors
- Log-on-demand and automatic logging (up to 45,000 samples) on meter for all parameters
- Graphical display of logged data

GOOGLE™ is a registered trademark of Google, Inc. HANNA instruments® has no affiliation with Google™, Inc.
iButton® is a registered trademark of Maxim/Dallas Semiconductor Corp.

- USB interface for PC communication
- Auto-ranging for EC, ISE and turbidity readings
- Good Laboratory Practice feature, the last 5 calibrations are automatically stored
- Field-replaceable sensors with color coded caps
- Meter can be powered with either alkaline or rechargeable batteries
- Fast charging capability

1.4 DISPLAY & KEYBOARD DESCRIPTION

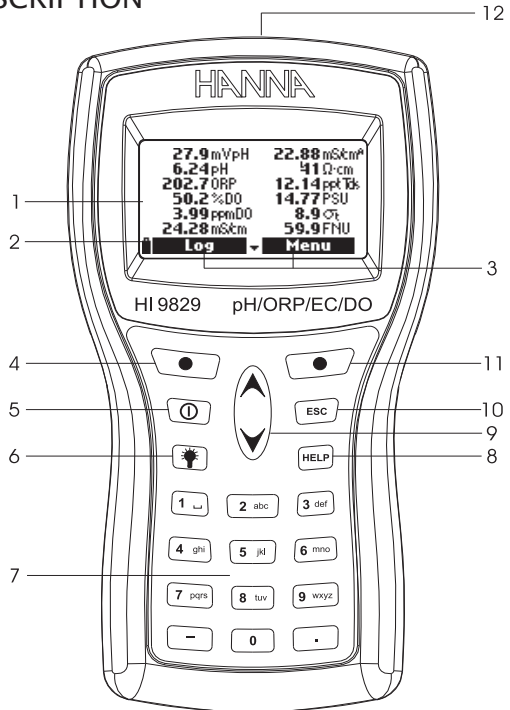

1. Graphic LCD
2. Battery level indicator
3. Softkey functions
4. Left softkey: function defined on display
5. On/Off key: turn the meter on and off
6. Lamp key: turn the backlight on and off
7. Alphanumeric keyboard: insert alphanumeric codes
8. HELP key: obtain information about the displayed screen
9. Arrow keys: scroll the displayed options/message
10. ESC key: return to the previous screen
11. Right softkey: function defined on display
12. GPS signal strength indicator (optional)
13. Tagreader

Chapter 2 - QUICK START

Before you begin using the **HI 9829** multiparameter system, either charge the included rechargeable C batteries for at least 6 hours or replace the rechargeable batteries with non-rechargeable alkaline batteries.

2.1 SENSOR AND PROBE INSTALLATION

- Sensor o-rings must be lubricated with the supplied grease prior to installation.
- HI 76x9829 probes have 3 sensor connectors identified with color-coded triangles:
- Connector 1 (red): For either pH/ORP, pH, ammonium, chloride or nitrate sensor
- Connector 2 (white): For dissolved oxygen sensor
- Connector 3: (blue): For either EC or EC/turbidity sensor
- Position the connector key towards the center of the probe, make sure the connector is seated correctly (the sensor will no longer move freely) before tightening the locking threads.
- To protect the sensors, screw the protective shield onto the probe body.
- Unscrew the battery cover of the HI 7629829 logging probe and install 4 AA batteries for autonomous logging before connecting to the meter.
- With the meter off, connect the probe to the DIN socket on the bottom of the meter. Align the pins and key then push the plug into the socket and tighten the thread.
- Turn the meter on by pressing the ON/OFF key. The meter will automatically recognize the probe and the installed sensors and identify them on the probe status screen.
- Press <Measure> to view the measurement screen.

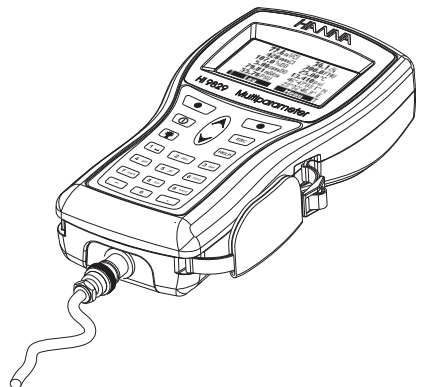

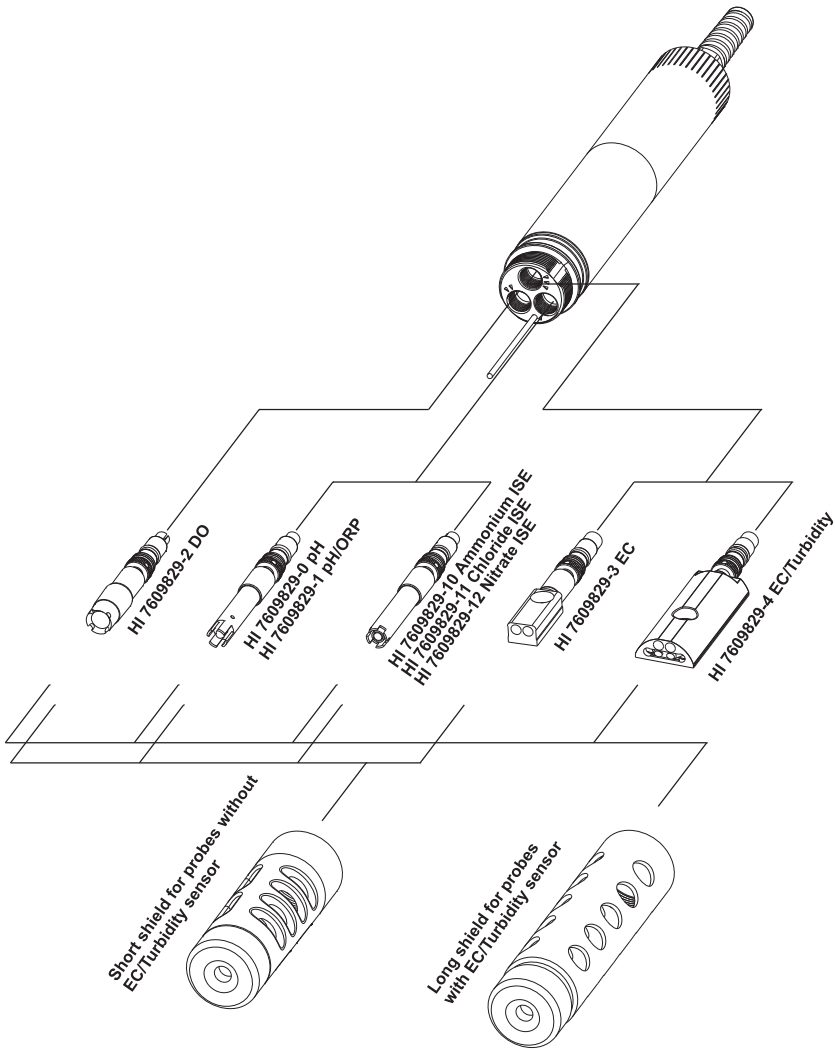

2.2 BASIC OPERATION

The main operating modes for HI 9829 are measurement, logging and setup. The measurement screen can be configured to display a single measurement or up to 12 simultaneous measurements by using the numbers 1-7 on the keypad. Use the arrow keys to scroll through the measurements not being displayed. See section 5.3 for more details.

The measurement units will blink if the system has not been calibrated and the measurement number will blink when the reading is out of range.

Press <Log> to display the logging menu. You can either log a single sample on the meter, start an interval log on the meter, or start an interval log on a logging probe (HI 7629829). See chapter 11 for more details.

Press <Menu> to enter setup mode. You can configure which parameters you want to measure, calibrate the sensors, change system settings, access the GPS menu and view the meter and probe status.

2.3 HELP FUNCTION

HI 9829 features context sensitive HELP, which provides useful information regarding the displayed screen.

Simply press the HELP key to access this function, then use the arrow keys to scroll through the message.

To escape from the HELP window, press the HELP key again or ESC.

Chapter 3 - SPECIFICATIONS

3.1 SYSTEM SPECIFICATIONS

TEMPERATURE

Range	-5.00 to 55.00 °C; 23.00 to 131.00 °F; 268.15 to 328.15 K
Resolution	0.01 °C; 0.01 °F; 0.01 K
Accuracy	± 0.15 °C; ± 0.27 °F; ±0.15 K
Calibration	Automatic at 1 custom point

pH/mV

Range	0.00 to 14.00 pH; ± 600.0 mV
Resolution	0.01 pH; 0.1 mV
Accuracy	± 0.02 pH; ± 0.5 mV
Calibration	Automatic 1, 2 or 3 points with automatic recognition of 5 standard buffers (pH 4.01, 6.86, 7.01, 9.18, 10.01) and 1 custom buffer

ORP

Range	± 2000.0 mV
Resolution	0.1 mV
Accuracy	± 1.0 mV
Calibration	Automatic at 1 custom point (relative mV)

DISSOLVED OXYGEN

Range	0.0 to 500.0 % 0.00 to 50.00 ppm (mg/L)
Resolution	0.1 % 0.01 ppm (mg/L)
Accuracy	0.0 to 300.0 %: ± 1.5 % of reading or ± 1.0 % whichever is greater; 300.0 to 500.0 %: ± 3 % of reading 0.00 to 30.00 ppm (mg/L): ± 1.5 % of reading or ±0.10 ppm (mg/L) whichever is greater; 30.00 ppm (mg/L) to 50.00 ppm (mg/L): ± 3 % of reading
Calibration	Automatic 1 or 2 points at 0, 100 % or 1 custom point

CONDUCTIVITY

Range	0 to 200 mS/cm (absolute EC up to 400 mS/cm)
Resolution	
<i>Manual</i>	1 μ S/cm; 0.001 mS/cm; 0.01 mS/cm; 0.1 mS/cm; 1 mS/cm
<i>Automatic</i>	1 μ S/cm from 0 to 9999 μ S/cm 0.01 mS/cm from 10.00 to 99.99 mS/cm 0.1 mS/cm from 100.0 to 400.0 mS/cm
<i>Automatic (mS/cm)</i>	0.001 mS/cm from 0.000 to 9.999 mS/cm 0.01 mS/cm from 10.00 to 99.99 mS/cm 0.1 mS/cm from 100.0 to 400.0 mS/cm
Accuracy	± 1 % of reading or ± 1 μ S/cm whichever is greater
Calibration	Automatic single point, with 6 standard solutions (84 μ S/cm, 1413 μ S/cm, 5.00 mS/cm, 12.88 mS/cm, 80.0 mS/cm, 111.8 mS/cm) or custom point

RESISTIVITY

Range	0 to 999999 Ω ·cm; (depending on measurement setup) 0 to 1000.0 k Ω ·cm; 0 to 1.0000 M Ω ·cm
Resolution	Depending on resistivity reading
Calibration	Based on conductivity or salinity calibration

TDS (Total Dissolved Solids)

Range	0 to 400000 ppm (mg/L); (the maximum value depends on the TDS factor)
Resolution	
<i>Manual</i>	1 ppm (mg/L); 0.001 ppt (g/L); 0.01 ppt (g/L); 0.1 ppt (g/L); 1 ppt (g/L)
<i>Automatic</i>	1 ppm (mg/L) from 0 to 9999 ppm (mg/L) 0.01 ppt (g/L) from 10.00 to 99.99 ppt (g/L) 0.1 ppt (g/L) from 100.0 to 400.0 ppt (g/L)
<i>Automatic ppt (g/L)</i>	0.001 ppt (g/L) from 0.000 to 9.999 ppt (g/L) 0.01 ppt (g/L) from 10.00 to 99.99 ppt (g/L) 0.1 ppt (g/L) from 100.0 to 400.0 ppt (g/L)
Accuracy	± 1 % of reading or ± 1 ppm (mg/L) whichever is greater
Calibration	Based on conductivity or salinity calibration

SALINITY

Range	0.00 to 70.00 PSU
Resolution	0.01 PSU
Accuracy	±2% of reading or ±0.01 PSU whichever is greater
Calibration	Based on conductivity calibration

SEAWATER SIGMA

Range	0.0 to 50.0 σ_t , σ_0 , σ_{15}
Resolution	0.1 σ_t , σ_0 , σ_{15}
Accuracy	± 1 σ_t , σ_0 , σ_{15}
Calibration	Based on conductivity or salinity calibration

TURBIDITY

Range	0.0 to 99.9 FNU; 100 to 1000 FNU
Resolution	0.1 FNU from 0.0 to 99.9 FNU 1 FNU from 100 to 1000 FNU
Accuracy	±0.3 FNU or ±2 % of reading, whichever is greater
Calibration	Automatic 1, 2 or 3 points at 0, 20 and 200 FNU, or custom

ISE

Ammonium-Nitrogen

Range	0.02 to 200.0 ppm Am (as NH_4^+ -N)
Resolution	0.01 ppm to 1 ppm 0.1 ppm to 200.0 ppm
Accuracy	±5 % of reading or 2 ppm
Calibration	1 or 2 point, 10 ppm and 100 ppm

Chloride

Range	0.6 to 200.0 ppm Cl (as Cl ⁻)
Resolution	0.01 ppm to 1 ppm 0.1 ppm to 200.0 ppm
Accuracy	±5 % of reading or 2 ppm
Calibration	1 or 2 point, 10 ppm and 100 ppm

Nitrate-Nitrogen

Range	0.62 to 200.0 ppm Ni (as NO ₃ ⁻ -N)
Resolution	0.01 ppm to 1 ppm 0.1 ppm to 200 ppm
Accuracy	±5 % of reading or 2 ppm
Calibration	1 or 2 point, 10 ppm and 100 ppm

ATMOSPHERIC PRESSURE

Range	450 to 850 mm Hg; 17.72 to 33.46 in Hg; 600.0 to 1133.2 mbar; 8.702 to 16.436 psi; 0.5921 to 1.1184 atm; 60.00 to 113.32 kPa
Resolution	0.1 mm Hg; 0.01 in Hg; 0.1 mbar 0.001 psi; 0.0001 atm; 0.01 kPa
Accuracy	±3 mm Hg within ±15°C from calibration temperature
Calibration	Automatic at 1 custom point

METER SPECIFICATIONS

Temperature Compensation	Automatic from -5 to 55 °C (23 to 131 °F)
Logging Memory	44,000 records (continuous logging or log-on-demand of all parameters)
Logging Interval	1 second to 3 hours
PC Interface	USB (with HI 929829 software)
Waterproof Protection	IP67
Environment	0 to 50 °C (32 to 122 °F); RH 100 %
Battery Type	4 x 1.2 V, NiMH, rechargeable batteries, size C or 4 x 1.5 V alkaline, C size batteries
Battery Life	See below
Dimensions/Weight	221 x 115 x 55 mm (8.7 x 4.5 x 2.2") / 750 g (26.5 oz.)
GPS	12 channel receiver 10 m (30 ft) accuracy

METER BATTERY LIFE

The power consumption of the HI 9829 multiparameter system is dependent on three things:

1. The measurement system configuration (probe type, sensor configuration)
2. The meter configuration (logging interval, GPS and backlight use)
3. The battery type (alkaline or rechargeable). Note: Alkaline batteries have two times the expected life.

The following table estimates the meter's battery life connected to a HI 76X9829 probe with backlight off. The logging interval only affects meter battery life when GPS Powersave mode is used (units with GPS). (Note: GPS and backlighting use consume the most power). The table variables are GPS, battery selection and parameter selection. Note: When a HI 7629829 logging probe is connected to a meter, it uses the meter's power.

	pH, ORP, DO, EC enabled Turbidity disabled	pH, ORP, DO, EC and Turbidity enabled
Alkaline batteries without GPS	280 hours	190 hours
Rechargeable batteries without GPS	140 hours	95 hours
Alkaline batteries with GPS	90 hours	70 hours
Rechargeable batteries with GPS	45 hours	35 hours
Alkaline batteries with GPS powersave on, 4 min log	110 hours	100 hours
Rechargeable batteries with GPS powersave on 4, min log	55 hours	50 hours
Alkaline batteries with GPS powersave on, 10 min log	180 hours	160 hours
Rechargeable batteries with GPS powersave on 10, min log	90 hours	80 hours

3.2 PROBE SPECIFICATIONS

	Non-logging Probe	Logging Probe
Sample Environment	Fresh, brackish, seawater	
Waterproof protection	IP68	
Computer Interface	NA	USB PC (HI 76982910)
Internal Battery Type	NA	4 X 1.5V Size AA Alkaline
Typical Battery Life	NA	See below
Memory	NA	140,000 measurements (single parameter logged)
		35,000 measurements (all parameters logged)
Operating Temperature	-5 to 55° C *	
Storage Temperature	-20 to 70° C	
Maximum Depth	20 m (66 ft.) *	
Dimensions (without cable)	HI 7609829 342mm (13.5"), dia=46 mm (1.8")	HI 7629829 442mm (17.4"), dia=46 mm (1.8")
	HI 7619829 382 mm (15.1"), dia=46 mm (1.8")	HI 7639829 482 mm (19.0"), dia=46 mm (1.8")
Weight (with batteries and sensors)	HI 7609829 570g (20.1 oz.)	HI 7629829 775g (27.3 oz.)
	HI 7619829 650g (22.9 oz.)	HI 7639829 819g (28.9oz.)
Cable Specification	Multistrand-multiconductor shielded cable with internal strength member rated for 68 kg (150lb) intermittent use	
Wetted Materials	Body:	ABS
	Threads:	Nylon
	Shield:	ABS/ 316 SS
	Temp probe:	316 SS
	O-rings:	EPDM

* Reduced for ISE sensors

LOGGING PROBE BATTERY LIFE

Interval	All channels logging (no averaging)	All channels logging (10 sample averaging)
1 - 5 sec	72 hours	72 hours
1 min	22 days	11 days
10 min	70 days	65 days

3.3 SENSOR SPECIFICATIONS

	HI 7609829-0	HI 7609829-1	HI 7609829-2	HI 7609829-3
Description	pH	pH/ORP	Dissolved Oxygen	EC
Measure Type				
Primary Unit	pH, mV (pH)	pH, mV (pH/ORP)	D.O. (% sat. & conc.)	EC
Measure Range	0.00 to 13.00 pH ±600.0 mV	0.00 to 13.00 pH ±600.0 mV ±2000.0 mV	0.0 to 500.0 % 0.00 to 50.00 mg/L	0.0 to 200.0 mS/cm 0.0 to 400 mS/cm (absolute)
Temperature Range	-5 to 55°C	-5 to 55°C	-5 to 55°C	-5 to 55°C
Color Code	Red	Red	White	Blue
Materials	Tip: glass (pH) Junction: ceramic Body: PEI Electrolyte: gel Reference: double	Tip: glass (pH); Pt (ORP) Junction: ceramic Body: PEI Electrolyte: gel Reference: double	Cat/An: Ag/Zn Membrane: HDPE Body: white top ABS CAP	Stainless steel electrodes AISI 316 Body: ABS/EPOXY
Maintenance Solution	HI 70300 (storage solution)	HI 70300 (storage solution)	HI 7042S (D.O. electrolyte)	none
Dimensions	118 x 15 mm	118 x 15 mm	99 x 17 mm	111 x 17 mm
Depth	20 m (65')	20 m (65')	20 m (65')	20 m (65')

HI 7609829-4 HI 7609829-10 HI 7609829-11 HI 7609829-12

	HI 7609829-4	HI 7609829-10	HI 7609829-11	HI 7609829-12
Description	EC/Turbidity	Ammonium ISE	Chloride ISE	Nitrate ISE
Measure Type	EC	ppm	ppm	ppm
Primary Unit	FTU			
Measure Range	0 to 200.0 mS/cm 0.0 to 400 mS/cm (abs) 0.0 to 1000 FNU	0.02 to 200.0 ppm as NH ₄ ⁺ -N	0.6 to 200.0 ppm Cl	0.6 to 200.0 ppm as NO ₃ ⁻ -N
Temperature Range	-5 to 55°C	0 to 40°C	0 to 40°C	0 to 40°C
Color Code		Red	Red	Red
Materials	Body: ABS/EPOXY PMMA	Tip: Polymeric Liquid Membrane Body: PEI Electrolyte: gel Reference: double	Tip: Solid State AgCl Pellet Body: PEI Electrolyte: gel Reference: double	Tip: Polymeric Liquid Membrane Body: PEI Electrolyte: gel Reference: double
Maintenance Solution	none	none	none	none
Dimensions	135 x 35 mm	118 x 15 mm	118 x 15 mm	118 x 15 mm
Depth	20 m (65')	5 m (16')	5 m (16')	5 m (16')

Chapter 4 - PROBE INSTALLATION

HI 7609829 and HI 7629829 multisensor probes are used for the measurements of pH, ORP, conductivity, turbidity, dissolved oxygen, chloride, nitrate-nitrogen, ammonium-nitrogen and temperature. Each probe can utilize 3 sensors. A description of each sensor follows.

4.1 SENSOR DESCRIPTIONS

HI 7609829-0 Combination pH sensor features a glass pH sensitive bulb and a silver/silver chloride double junction reference with gelled electrolyte.

HI 7609829-1 Combination pH/ORP sensor features a glass sensitive bulb for pH readings, a platinum sensor for redox measurements and a silver/silver chloride double junction reference with gelled electrolyte.

Note See section 4.2.1 for pH preparation.
See section 4.2.2 for ORP activation.

HI 7609829-2 Galvanic dissolved oxygen (D.O.) sensor. The thin gas permeable membrane isolates the sensor elements from the testing solution but allows oxygen to pass through. The oxygen that passes through the membrane is reduced at the cathode and causes a current, from which the oxygen concentration is determined. The D.O. sensor conforms to Standard Methods 4500-AG, EPA 360.1.

Note The D.O. sensor needs to be activated before installation. See section 4.2.3 for details.

HI 7609829-3 4-electrode conductivity sensor. The sensor is immune to polarization or surface coatings.

The HI 7609829-4 Combination EC/Turbidity sensor. It includes a 4-electrode conductivity sensor and a turbidity sensor that conforms to ISO 7027 standards in a single sensor body. The turbidity sensor uses an optical technique to measure suspended particles in water.

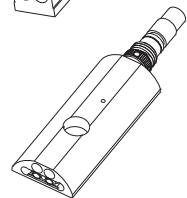
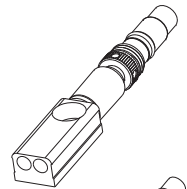
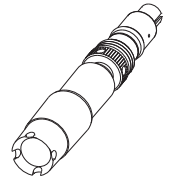
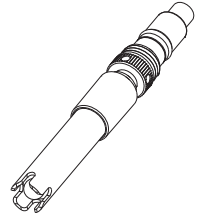

HI 7609829-10: Ammonium selective electrode (ISE) is a combination liquid membrane sensor used for the detection of free ammonium-nitrogen in freshwater samples. The sensor utilizes a polymeric membrane made with ammonium ionophore in a PVC head and silver/silver chloride double junction gel filled reference electrode. This sensor is used in place of the pH sensor in the probe.

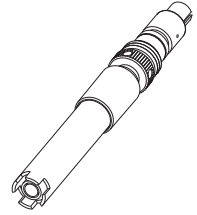

HI 7609829-11: The Chloride ISE is a combination solid state sensor used for the detection of free chloride ions in freshwater samples. The sensor utilizes a silver chloride pellet housed in a PEI head and a silver/silver chloride double junction gel filled reference electrode. This sensor is used in place of the pH sensor in the probe.

HI 7609829-12: The Nitrate ISE is a combination liquid membrane sensor used for the detection of nitrate nitrogen in freshwater samples. The sensor utilizes a polymeric membrane made with nitrate ionophore in a PVC head and a silver/silver chloride double junction gel filled reference electrode. This sensor is used in place of the pH sensor in the probe.

See Appendix C for details regarding the ISE sensors.

4.2 SENSOR PREPARATION / ACTIVATION

4.2.1 pH Preparation

Remove the shipping cap from the pH sensor. If the shipping cap does not contain any liquid, pour HI 70300 into shipping cap, place it back on the sensor and soak for at least 1/2 hour before use. If HI 70300 is not available, pH 4.01 buffer may be substituted.

4.2.2 ORP Activation

For improved redox measurements, the surface of the sensor must be clean and smooth. A pretreatment procedure should be performed to ensure quick response.

The pretreatment of the sensor is determined by the pH and the ORP potential values of the sample. Use the table below to determine the treatment required. First locate the typical sample pH. If the corresponding ORP value (mV) is higher than the values in the table below, an oxidizing pretreatment is necessary. If the value is lower, a reducing pretreatment is necessary.

pH	mV	pH	mV	pH	mV	pH	mV	pH	mV
0	990	1	920	2	860	3	800	4	740
5	680	6	640	7	580	8	520	9	460
10	400	11	340	12	280	13	220	14	160

For reducing pretreatment: immerse the electrode for at least five minutes in HI 7091.

For oxidizing pretreatment: immerse the electrode for at least five minutes in HI 7092.

4.2.3 D.O. Sensor Activation

The D.O. probe is shipped dry. To prepare the sensor for use:

- Remove the black & red plastic cap. This cap is used for shipping purposes only and can be thrown away.
- Insert the supplied O-ring in to the membrane cap.
- Rinse the membrane with some electrolyte solution. Refill with clean electrolyte. Gently tap the membrane cap to dislodge air bubbles. To avoid damaging the membrane, do not touch it with your fingers or directly tap the membrane.

- With the sensor facing down screw the membrane cap counterclockwise to the end of the threads. Some electrolyte will overflow.
- Rinse outside of sensor with deionized water.
- Invert sensor and inspect. There should be no bubbles or debris between the membrane and sensor body.

4.2.4 EC and EC/Turbidity Sensor Preparation

The EC and EC/Turbidity sensors do not need to be soaked or hydrated before use. Use the small brush included in the probe maintenance kit to clean and loosen any debris before using.

4.2.5 Ammonium Sensor Preparation

Remove the shipping cap and inspect sensor. Verify no air pockets have developed near the ceramic junction during shipping. Hold the sensor at the connector and shake it down (like a mercury thermometer). Condition the sensor by soaking it in a small amount of **HI 9829-10**, 10 ppm NH_4^+ -N standard for at least a 1/2 hour.

4.2.6 Chloride Sensor Preparation

Remove the shipping cap and inspect sensor. Verify no air pockets have developed near the ceramic junction during shipping. Hold the sensor at the connector and shake it down (like a mercury thermometer). Condition the sensor by soaking it in a small amount of **HI 9829-12**, 10 ppm Cl⁻ standard for at least a 1/2 hour.

4.2.7 Nitrate Sensor Preparation

Remove the shipping cap and inspect sensor. Verify no air pockets have developed near the ceramic junction during shipping. Hold the sensor at the connector and shake it down (like a mercury thermometer). Condition the sensor by soaking it in a small amount of **HI 9829-14**, 10 ppm NO_3^- -N standard for at least a 1/2 hour.

4.3 SENSOR INSTALLATION

The HI 76x9829 can support 3 different sensors: Connector 1: pH, pH/ORP or ISE (Ammonium, Chloride, Nitrate), Connector 2: D.O., Connector 3: EC or EC/Turbidity.

To make installation easier, the sensors have color-coded caps and the sockets are identified with colored triangles.

Note The EC/Turbidity sensor with 9 pin connector does not have a color-coded cap. It is always installed into the socket with three blue triangles.

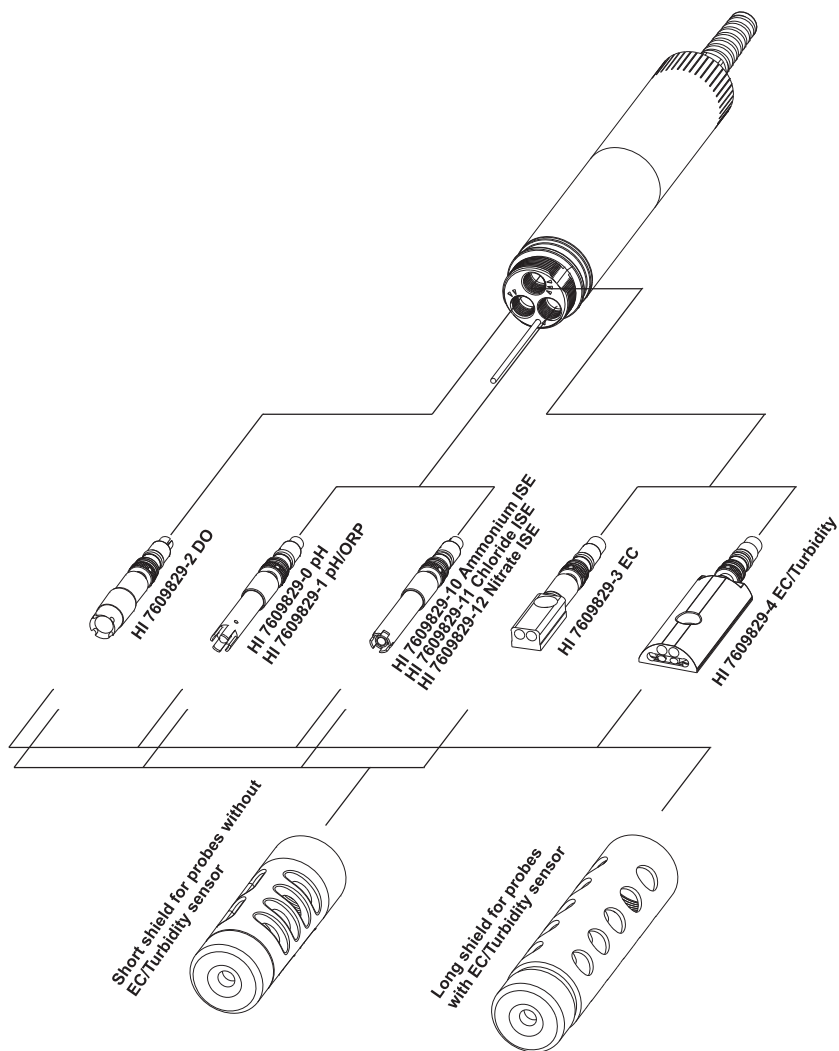

For a correct installation:

- Grease the sensor O-ring with the lubricant found in the probe maintenance kit. **DO NOT SUBSTITUTE** other grease/lubricants as it may cause the O-ring to swell.
- Insert the sensor into the correctly color coded opening while positioning the connector key toward the center of the probe. Make sure the connector is seated correctly (the sensor will no longer move freely) before tightening the locking threads with your fingers.
- Continue to tighten the locking threads with the tool supplied in the maintenance kit until the sensor is secured tightly against the probe body.
- To protect the sensors, screw the protective shield onto the probe body.
- With the meter off, connect the probe to the DIN socket on the bottom of the meter. Align the pins and key then push the plug into the socket. Tighten the knurled, threaded shell.
- Turn on the meter by pressing the ON/OFF key. The meter should automatically recognize the installed sensors and identify them on the probe status screen. If you have an error message or the sensor is not recognized, reconnect the sensor(s) or probe and try again.



Chapter 5 - INITIALIZATION AND MEASUREMENT

5.1 BATTERY INSTALLATION

HI 9829 is supplied with 4 rechargeable, size C NiMH (Nickel-metal hydride) batteries.

The battery symbol on the LCD indicates the remaining battery charge. The meter has a low battery warning, and when the symbol starts blinking, batteries should be charged or replaced with new ones. When the batteries are discharged the meter will automatically shut off to avoid erroneous readings.

5.1.1 Meter Battery Installation

Replace batteries in nonhazardous areas only. Remove the 4 screws on the rear of the instrument and insert the batteries observing polarity.

If you wish to replace the supplied rechargeable batteries with nonrechargeable alkaline batteries, move the switch in the battery compartment upward.

A warning message is displayed if you connect the charging cable to a meter with alkaline batteries.

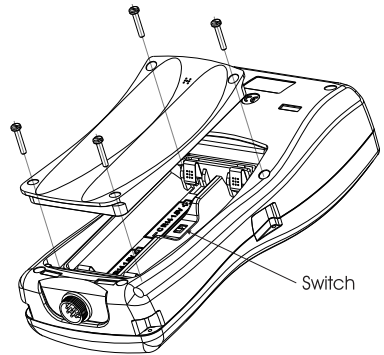

Nonrechargeable alkaline batteries can explode or leak if you try to charge them. Verify that the switch is in the up position when using alkaline batteries to prevent recharging.

Note: Do not mix old and new alkaline batteries.

5.1.2 Charging Meter Batteries

Two cables are available for charging the HI 9829 batteries: HI 710045 and HI 710046.

AC power supply

In order to charge the rechargeable batteries, use the HI 710045 cable and the 12Vdc power adapter.

- With the meter OFF, disconnect the probe.
- Connect the HI 710045 cable to the probe connector on the meter and power adapter, then connect the adapter to an AC power outlet.
- The battery charging animation will be displayed.

It takes about 6 hours to completely charge fully discharged batteries.

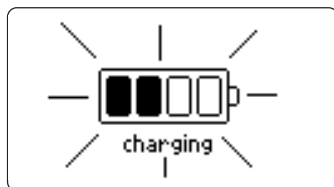

Note The meter log, GPS information, system setup and status can be viewed during battery charging. The battery charging status is indicated by a small animated battery icon found in the lower left corner.

During charging the meter may feel quite warm. This is normal.

“Battery temp” (under “Meter Status”) may display values approaching 50 °C.

Automotive auxiliary power outlet (Cigarette lighter receptacle)

To charge batteries from a automotive auxiliary power outlet, use HI 71 0046 cable.

- Connect the HI 71 0046 cable to the probe connector on the meter and to the auxiliary plug.
- The battery charging animation will be displayed.

A complete battery charging will take about 6 hours if they are completely discharged.

5.1.3 Probe Battery Installation (for logging probes only)

To install probe batteries:

Replace batteries in a nonhazardous area only. Remove the battery cover by turning it counterclockwise. Insert the batteries observing polarity.

Note: Do not mix old and new batteries.

Replace the battery cover by engaging the threads and turning it clockwise. Continue turning until it is flush with probe body.

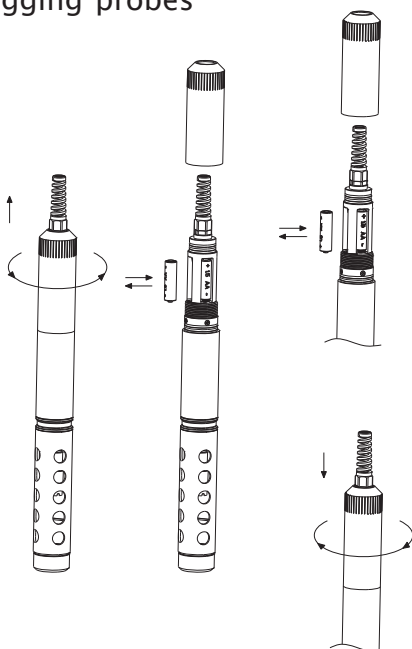

5.2 METER INITIALIZATION

After connecting the desired sensors to the probe and connecting the probe to the meter (see previous chapter), turn the meter on by pressing ON/OFF.

After the initialization has been completed, the meter displays the PROBE STATUS SCREEN.

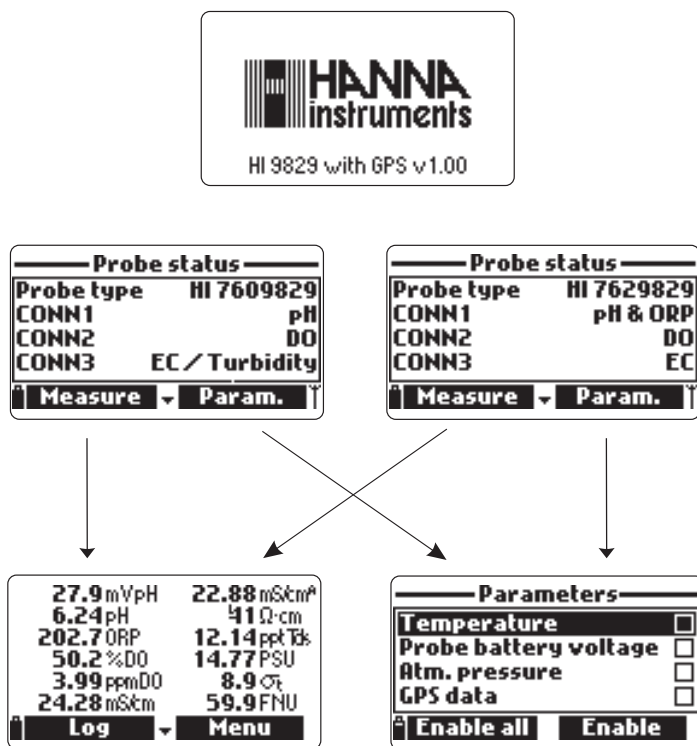

The probe status screen identifies the probe and attached sensors. Non-logging probes are identified as HI 7609829 and logging probes are identified as HI 7629829.

Two active soft keys are found at the bottom of the status screen.

- Press <Measure> to access the measurement mode.
- Press <Param> to access the "Select Parameter" menu. (This screen can also be accessed from the main menu, see Chapter 6 for a detailed description.).
- Press the DOWN arrow to view additional information about the probe.

5.3 MEASUREMENT MODE

Measurement mode is one of the three main operating modes of HI 9829 (along with logging mode and setup mode).

During measurement mode HI 9829 will simultaneously measure data for all enabled parameters.

- Use the numbers on the keyboard to select the number of parameters that are shown on the screen at one time. The display will automatically resize the font.

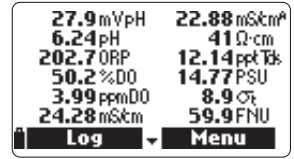
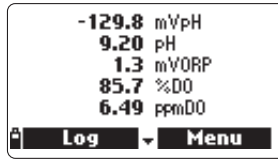
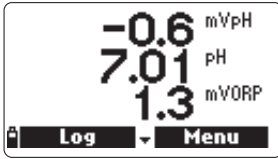

- Press the [up] and [down] arrows to scroll through the enabled parameters if they do not fit on one screen.

Note A flashing measurement value indicates that the measurement is out of range.

A flashing measurement unit indicates that the user calibration has not been done and is needed for accurate readings.

- Press <Log> to enter the log menu. See Chapter 11 for details.
- Press <Menu> to enter the main setup menu. The main menu accesses the parameter setup, calibration, system setup, GPS and status options. See the following chapters for details.

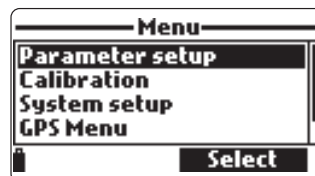
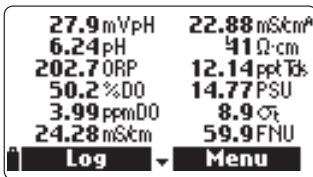

5.4 SETUP MENU STRUCTURE

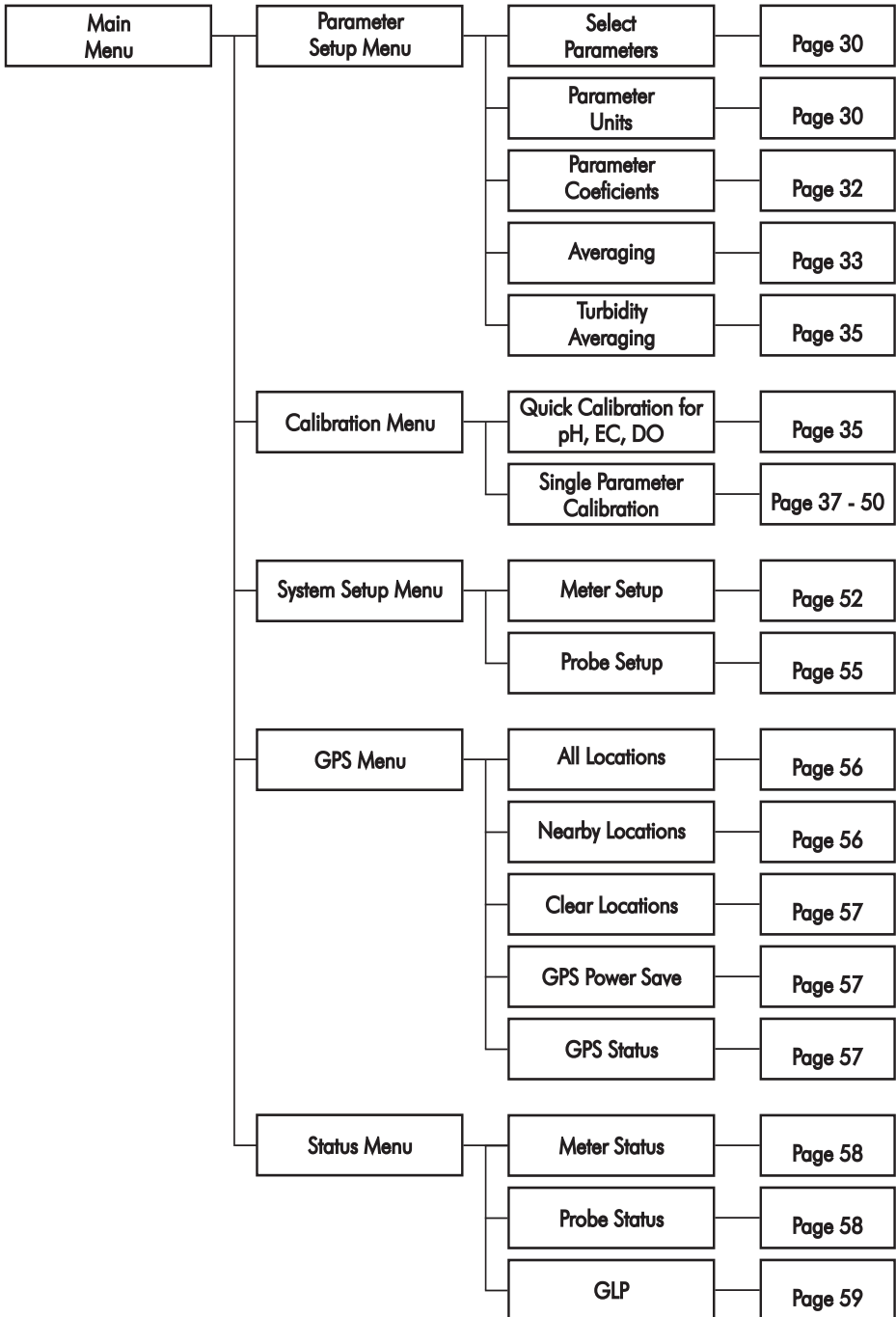

Chapter 6 - PARAMETER SETUP MENU

From the main menu, use the arrow keys to highlight "Parameter Setup" and then press <Select>.

The following options will be displayed:



6.1 SELECT PARAMETERS

Use the arrow keys to scroll through the menu. Press the right softkey to enable or disable a single parameter, or the left softkey to enable or disable all parameters. A checked box means that the parameter is enabled.

Only the available parameters are present in the list.

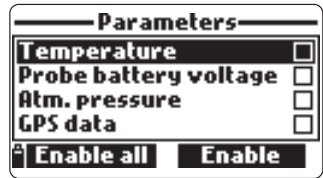

Note: If the password protection is enabled, you will be required to enter the password before any parameters can be modified.

6.2 PARAMETER UNITS

6.2.1 Temperature Unit

The user can select the measurement unit: °C, °F or K. The default value is °C.

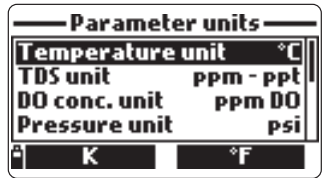

6.2.2 TDS Unit

The user can select ppm - ppt or mg/L - g/L measurement unit. The default value is ppm - ppt.

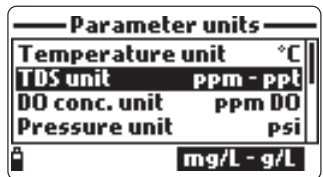

6.2.3 DO Concentration Unit

The user can select ppm or mg/L. Dissolved Oxygen concentration is calculated using % saturation, conductivity and atmospheric pressure. The default value is ppm.

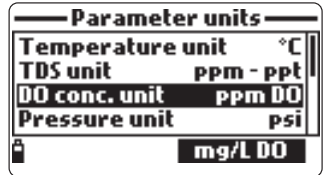

6.2.4 Pressure Unit

The user can select one the following measurement units: psi, mmHg, inHg, mbar, atm, kPA. The default value is psi.

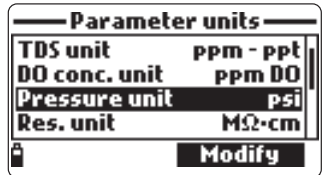

6.2.5 Resistivity Unit

The user can select resistivity from one of the following measurement units: $\Omega \cdot \text{cm}$, $\text{k}\Omega \cdot \text{cm}$ or $\text{M}\Omega \cdot \text{cm}$. Resistivity is calculated from the conductivity measurement. The default unit is $\text{M}\Omega \cdot \text{cm}$.

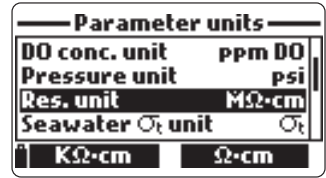

6.2.6 Seawater Sigma Unit

This parameter is used for seawater analysis. It is calculated from the conductivity measurement and depends on water pressure, temperature and salinity. The default value is σ_t .

Users can select the reference temperature: σ_t , σ_0 and σ_{15} (i.e. current temperature, 0°C or 15°C).

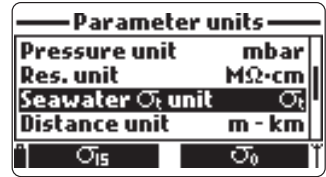

6.2.7 Distance Unit (GPS unit)

Select between m - km or ft - mi. This unit will be associated with position. The default values is m - km.

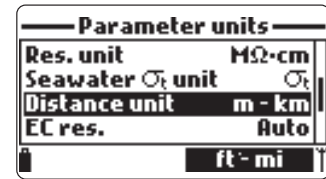

6.2.8 EC Resolution

The user can configure the conductivity resolution with one of the following options:

Auto: the meter automatically chooses the range to optimize the measurement. Readings can be in $\mu\text{S}/\text{cm}$ or mS/cm .

Auto mS/cm : the meter automatically chooses the range to optimize the measurement, readings will be in mS/cm only.

$1\mu\text{S}/\text{cm}$, $0.001\text{ mS}/\text{cm}$, $0.01\text{mS}/\text{cm}$, $0.1\text{mS}/\text{cm}$ or $1\text{mS}/\text{cm}$: the meter will not autorange, the measurement will be displayed with the selected resolution. The default value is Auto.

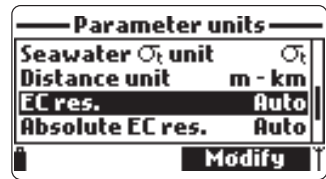

6.2.9 Absolute EC Resolution

Absolute conductivity displays the conductivity without temperature compensation. See 6.2.8 EC resolution for resolution details.

Note A small letter "A" added to the $\mu\text{S}/\text{cm}$ or mS/cm unit refers to an absolute conductivity value (i.e. a conductivity reading with no temperature compensation).

6.2.10 TDS Resolution

The user can configure the TDS resolution with one of the following options:

Auto: the meter automatically chooses the range to optimize the measurement, readings can be in ppt or ppm.

Auto ppt: the meter automatically chooses the range to optimize the measurement, readings will be in ppt only.

1 ppm, 0.001 ppt, 0.01 ppt, 0.1 ppt or 1 ppt: the meter will display the measurement with selected resolution. The default value is Auto.

6.2.11 GPS Format (optional)

Global positioning coordinates have three standard formats: XX°XX'XX.X'', XX°XX.XXX' and XX.XXXXX°. The selected format will be used in any screen where the GPS coordinates are displayed. The default format is XX°XX'XX.X.



6.3 PARAMETER COEFFICIENTS

6.3.1 EC Reference Temperature

This value is used for temperature compensated conductivity. All EC measurements will be referenced to the conductivity of a sample at this temperature. Press the softkey to select the desired option; 20 °C or at 25 °C. The default value is 25 °C.

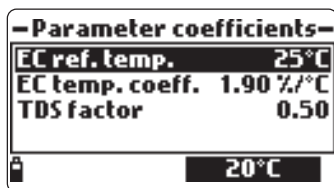

6.3.2 EC Temperature Coefficient

The temperature coefficient Beta (β) is defined by the following equation (using 25 °C as an example):

$$EC_{25} = EC_x / (1 + \beta(T_x - 25))$$

Beta is a function of the solution being measured. For freshwater samples Beta is approximately 1.90%/°C. If the actual temperature coefficient of your sample is known, press <Modify> to enter the value. To confirm press <Accept>. The value can be within 0.00 and 6.00%/°C. The default value is 1.90%/°C.

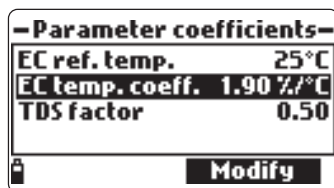

6.3.3 TDS Factor

TDS stands for total dissolved solids, and it is a calculated value based on the conductivity of the solution ($TDS = \text{factor} \times EC_{25}$). The TDS conversion factor can be set from 0.00 to 1.00. A typical TDS factor for strong ionic solutions is 0.5, while for weak ionic solutions (e.g. fertilizers) is 0.7. Press <Modify> to enter the value, press <Accept> to confirm. The default value is 0.50.

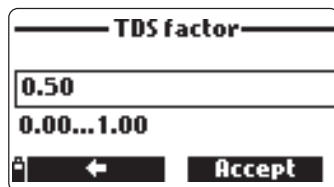

6.4 AVERAGING

Averaging is a software filter to minimize sensor noise and provide more stable readings. Averaging is particularly useful to get a representative reading of the “average” value from flowing water. Averaging will affect all measurements (except Turbidity which can be set separately). This value should be kept low if you want a fast response. Press <Modify> to select the desired number of samples to average. This value can be set from 1 to 20 samples. The default value is 1.

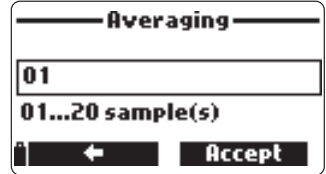
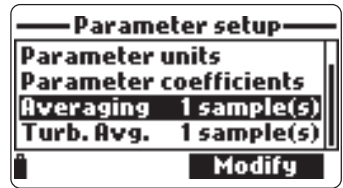

Note Each reading takes 1 second, so when logging the first sample will be delayed by a few seconds if averaging is used.

6.5 TURBIDITY AVERAGING

Turbidity averaging is software filter to minimize noise and provide more stable readings for turbidity. This parameter can be set without affecting the response times of other measurements.

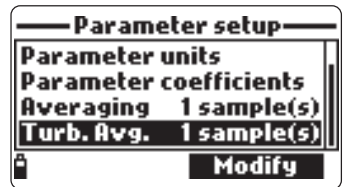

As is the case for the other measurements, averaging is useful to provide representative readings of the “average” value in flowing water. Turbidity averaging can be set separately because the optical turbidity sensor is more strongly affected by bubbles and debris in the water stream than the other sensors.

Press <Modify> to enter the number of samples to average. The value can be set from 1 to 20 samples. The default value is 1.

Chapter 7 - CALIBRATION MODE

HI 9829's calibration routines are accessed by highlighting "Calibration" and pressing <Select> from the main menu. Calibration is the process that standardizes the electrical or optical signals from the sensors to reagent standards of known value.

Calibrations are intuitive and menu driven. All calibration data is stored in the non volatile probe memory, allowing probes to be connected to different meters without recalibration.

There are two types of calibrations available: the "Quick calibration", which is used for a single point calibration of pH, Conductivity, and/or Dissolved Oxygen and is handy for field work; and the "Single param. calibration" that allows each parameter to be calibrated individually. The user may also restore each parameter to a factory default calibration.

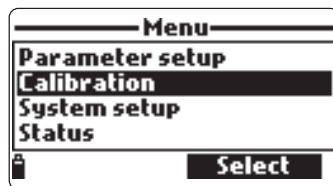

Note The password will be required if password protection is enabled.

To optimize measurements, it is advisable to establish the optimum calibration period required for the measurement environment.

Calibration requirements vary with deployment conditions, for example very turbid biologically-active waters may require more frequent cleanings and calibrations than cleaner waters.

General calibration guidelines are listed below:

- Set up a routine service schedule where measurement integrity is validated. This is especially important for new installation sites or long deployments.
- Inspect sensor connectors for corrosion and replace damaged sensors.
- Inspect sensor o-rings for damage and if necessary replace and lubricate with the grease found in the probe maintenance kit.
- Do not handle the sensing surfaces of the sensors.
- Avoid rough handling and abrasive environments that can scratch the reactive surfaces of the sensors.
- Avoid long-term exposure of sensors to bright sunlight (especially chloride ISE). If possible, calibrate in a shaded area.
- Discard standards after use. Do not return the used standards to the bottles of "fresh" solution.
- For measurements across a temperature gradient (when water temperature is drastically different from the standards), permit the sensors to reach thermal equilibrium before conducting calibrations or making measurements. The heat capacity of the probe is much greater than the air and the small beakers of calibration standards.

7.1 QUICK CALIBRATION

The quick calibration method provides a quick single point calibration for pH, conductivity and dissolved oxygen sensors. HI 9828-25 calibration solution is used for both pH and conductivity.

- Fill the calibration beaker 2/3 full with HI 9828-25 calibration solution.
- Slowly place the sensors into the solution and dislodge bubbles that may adhere to the sensors.
- Screw the calibration beaker completely on the probe body. Some solution may overflow.
- Wait a few minutes for the system to stabilize.
- From the "Calibration" menu select "Quick calibration".

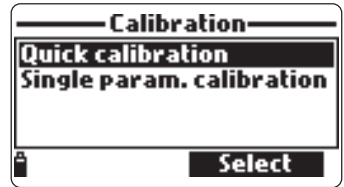

- A three item calibration menu will appear (pH, Conductivity and Dissolved oxygen) and "pH" will start to blink along with the "Not ready" message.

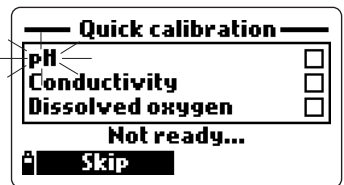

- When the pH signal is stable, the "Ready" message appears. Press <Confirm> to store the calibration data.
- The "Storing" message will appear as the calibration proceeds to the next sensor. A checkmark will appear in the box next to "pH" to indicate a successful calibration.

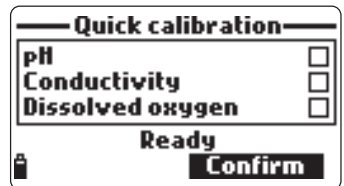

Note To bypass any of the calibrations press <Skip> to move to the next sensor in the quick calibration menu.

If the pH sensor is not installed the message "pH sensor not installed! Skip to conductivity calibration" will appear.

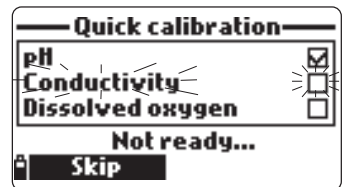

- Following the pH calibration, "Conductivity" will start to blink along with the "Not ready" message.
- When the measurement is stable, "Ready" appears. Press <Confirm> to store the calibration data and the "Storing" message will appear.

Note If EC calibration is not required, skip to the D.O. quick calibration by pressing the <Skip> softkey.

- The message "Empty the beaker." will appear.

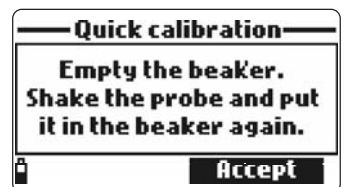

- Unscrew the calibration beaker and empty the solution.
- Shake any remaining liquid off the probe and beaker. No droplets should remain on the D.O. sensor membrane.

Note Do not attempt to dry wipe the D.O. sensor as damage to the membrane may occur.

- Screw the empty calibration beaker on the probe body. The beaker should not be dry.
- Press <Accept> to close the displayed message.
- When the measurement is stable, "Ready" appears. Press <Confirm> to store the calibration data and the "Storing" message will appear.
- Press <OK> to return to "Calibration" menu.

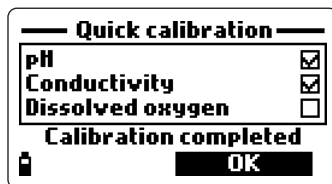

Note To quit the quick calibration procedure, press ESC at any time.

After every calibration the quick calibration window will show a check mark in the box next to the calibrated parameter.

7.2 pH CALIBRATION

To optimize the pH measurement follow the general guidelines mentioned in the Chapter 7 introduction.

From the "Calibration" menu select "Single param. calibration" and then "pH calibration". The display shows two options: "Calibrate pH" and "Restore factory calib."

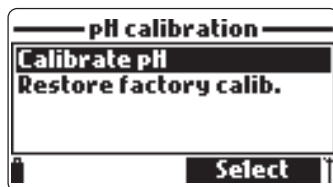

If a new pH sensor has been installed use "Restore factory calib." before performing a user calibration

as some warning messages are based on changes from previous calibrations.

If "Restore Factory Calib" is selected, all user calibration data will be deleted and the default calibration is restored. A user calibration should follow immediately.

If "Calibrate pH" is selected, the user can perform a new calibration using up to 3 buffers (pH 4.01, 6.86, 7.01, 9.18, 10.01 or one custom buffer).

When a 3-point calibration is performed, all old data are overwritten, while with a single or 2-point calibration the meter will also use information from the previous calibration.

7.2.1 Preparation

Pour small quantities of the selected buffer solutions into clean beakers. To minimize cross contamination, use two beakers for each buffer solution: the first one for rinsing the sensor and the second one for calibration.

7.2.2 Procedure

The measured pH value is displayed, along with the temperature and the buffer value on the second level.

If necessary, press the <Cal point> softkey and use the arrow keys to select the correct buffer.

- Immerse the sensors in the first buffer rinse solution and stir gently.
- Immerse the pH sensor and temperature probe into the selected buffer and stir gently. The temperature, pH buffer value and the "Not ready" message are displayed.
- Once the reading has stabilized the countdown timer will count down until the display shows the "Ready" message.
- Press <Confirm> to accept the calibration point.

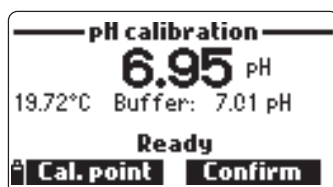
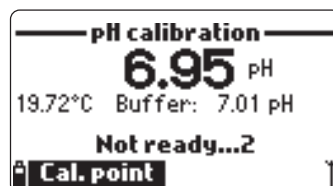

- After the calibration point is confirmed, to avoid cross-contamination immerse the sensors in the next calibration buffer rinse solution and stir gently.
- Press <Cal Point> to select the next buffer (if necessary), and repeat the calibration procedure outlined above with the second and third buffers.

Note The calibration procedure can be terminated after a single or 2 point calibration by pressing <ESC>. The message “Storing” followed by “Calibration completed” will be displayed.

- Press <OK> to return to the Calibration menu.
- Press <Measure> to return to the measurement screen.

Custom buffer calibration

The HI 9829 permits a single custom buffer to be used for pH calibration. This can be used along with standard buffers as part of a 2 or 3 point calibration or as a single point.

- To select this option first press <Cal. point> and then <Custom> while the meter is waiting for stable reading.
- A text box window will appear. Use the keypad to enter the value of the buffer at the current temperature. The valid range for custom a buffer is from 0.00 to 14.00 pH.

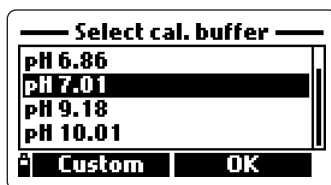

7.2.3 pH Calibration Error Messages

The HI 9829 displays a series of messages if an error has occurred during calibration.

If the meter does not accept a pH calibration point, a short message is displayed to indicate the possible error source. The following screens are examples:

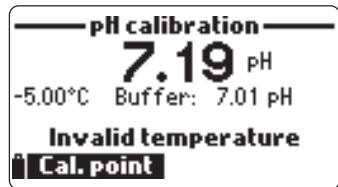
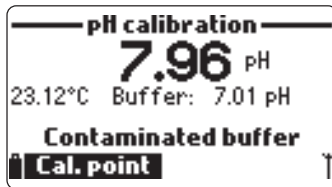
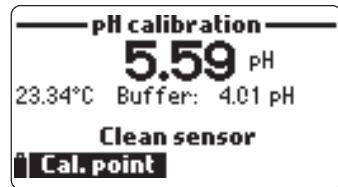
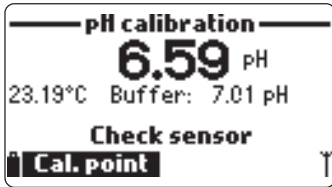

These are the available messages:

- "Input out of scale": the pH value is out of range. The pH sensor may require replacement.
- "Check sensor": the electrode may be broken, very dirty or the user has attempted to calibrate the same buffer value twice.
- "Wrong buffer": the displayed pH reading is too far from the selected buffer value. This is often seen immediately after a buffer calibration has been completed but before the pH sensor has been moved to the next buffer. Check if the correct calibration buffer has been selected.
- "Invalid temperature": the buffer temperature is outside the acceptable range.
- "Wrong buffer" / "Contaminated buffer" / "Check electrode": the buffer is contaminated or the sensor is broken or very dirty.
- "Check sensor" / "Clean sensor": the electrode is broken or very dirty.
- "Wrong" / "Clear old calibration": erroneous slope condition. These messages appear if the slope difference between the current and previous calibration exceeds the slope window (80% to 110%). Press the <Clear> softkey to cancel the old data and continue the calibration procedure, or press ESC to quit the pH calibration mode.

7.3 ISE CALIBRATION

From the "Calibration" menu select "Single param. calibration" and then "ISE calibration". The display shows two options: "Calibrate ISE" and "Restore factory calib".

When an ISE replaces a pH sensor or another ISE model, previous calibrations need to be cleared using the <Restore factory calib.> option first.

If "Calibrate ISE" is selected, the user can perform a single (10 ppm) or 2 point calibration with standard 10 ppm and 100 ppm solutions.

If "Restore Factory Calib" is selected, all user calibration data will be deleted and the default calibration is restored.

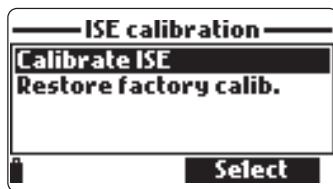

Notes The ppm tag will blink when a user calibration was not performed.

When a 2-point calibration is performed, all of the old data is overwritten, whereas for a single point calibration the meter will also use information from the previous calibration.

7.3.1 Preparation

Prepackaged standards are available in single use sachets. Rinse the ISE with water and shake off excess water. The procedure always uses 10 ppm first.

7.3.2 Procedure

Cut open the 10 ppm sachet and pour a small quantity of standard over the ISE tip to rinse the sensor. This should be done over a waste container. Immerse the **ISE sensor and temperature probe** into the standard. Position the sachet to ensure sensor membrane and ceramic junction are completely covered with solution.

The current measurement or dashes, temperature, the standard value and the "Not ready" message are displayed.

- Once the ISE has stabilized the countdown timer will count down until the display shows the "Ready" message.
- Press <Confirm> to accept the calibration point.
- After the first calibration point is confirmed, remove sensor from sachet packet and shake standard off. Blot excess with a soft tissue. Cut open the 100 ppm sachet. Immerse the ISE sensor and temperature probe into the standard.

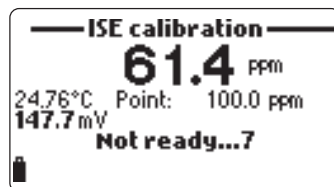
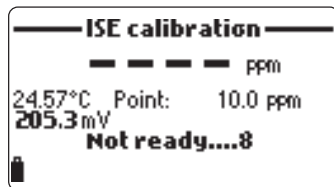

Position the sachet to ensure sensor membrane and ceramic junction are completely immersed in solution. A value close to 100 ppm and the message "Not ready..." will be displayed.

- When the reading is stable, the countdown timer will count down until the display shows the "Ready" message.
- Press <Confirm> to accept the calibration.
- After the second calibration point is confirmed the display shows the following messages: "Storing" and "Calibration completed".
- Press <OK> to return to the Calibration menu.
- Press <Measure> to return to the measurement screen.

Note The ISE calibration mode can be exited at any time, by pressing the ESC key.

7.4 ORP CALIBRATION

The "ORP calibration" allows the user to perform a single point custom calibration (relative mV) or to restore the factory calibration.

The Oxidation-Reduction Potential (ORP), displayed in mV, is the voltage that results from the difference in potential between the platinum ORP sensor and the silver/silver chloride reference electrode. ORP values are not temperature compensated, although ORP values can change with temperature (e.g. reference electrode potential changes, sample equilibrium changes). It is important to report ORP values together with the reference electrode used and the temperature.

The inert platinum ORP surface provides an electron exchange site with the sample (or standard) and its surface. The electron exchange is typically very fast in well-poised solutions (standards for example), but may be more lengthy in natural water samples.

Calibration is typically not required for a new ORP sensor, but the process does establish a baseline that can be used as a comparison for future validations.

Calibration is used to compensate for changes due to contamination of the platinum surface and drift in the reference electrode.

A relative mV calibration can also be made to remove the voltage attributable to the Ag/AgCl reference electrode (to display the ORP versus a SHE (standard hydrogen electrode)). This is really an arithmetic correction and is correct only at the standard temperature. For example, HI 7022L reads 470 mV at 20°C versus the Ag/AgCl reference. The ORP mV versus a SHE would be 675 mV. (add 205 mV to the observed value).

7.4.1 Preparation

Appendix D – ACCESSORIES lists Hanna solutions used for ORP calibrations. The calibration should be conducted at temperatures between 20-26°C. The sensor should be clean and oil free.

7.4.2 Procedure

- From the “Calibration” menu select “Single param. calibration” and then “ORP calibration”. The display shows two options: “Custom ORP” and “Restore factory calib.”.
- For a user calibration select “Custom ORP”.
- Fill a beaker with an ORP test solution (see APPENDIX D “Accessories”).
- Using the keypad, insert the numerical ORP value and then press <Accept> to confirm.
- The stability counter will count down and the message “Ready” and <Confirm> will be displayed.
- Press <Confirm> to accept the calibration point.
- After confirmation, the following messages are displayed: “Storing” and “Calibration completed”.
- Press OK to return to the Calibration menu.
- Press <Measure> to return to the measurement screen.
- To restore the factory calibration data, select the corresponding option in the “ORP calibration” menu and then press <Select>.

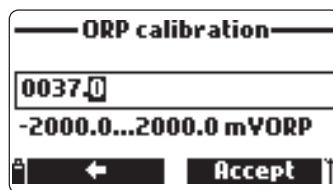
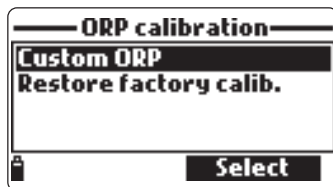

7.5 DISSOLVED OXYGEN CALIBRATION

The accuracy of dissolved oxygen measurements is directly related to membrane cleanliness and calibration technique. Oily coating and biological contaminants are the primary cause of calibration drift in dissolved oxygen sensors. Unfortunately, brushes or other cleaning objects may damage the membrane. Replacing the membrane cap and electrolyte is the best way to perform periodic maintenance.

Although it may be easier to calibrate the D.O. sensor prior to deployment, it is advised to calibrate at the site of deployment. Errors in measurement may result if altitude and barometric pressure differ between the calibration and measurement site. This is very important for autonomously logging probes.

Note Perform either the % D.O. Saturation or D.O. Concentration calibration.

If the % D.O. saturation range is calibrated, the D.O. concentration range will also be calibrated, and vice versa.

Dissolved oxygen concentration values are based on % D.O. saturation, temperature, salinity and atmospheric pressure. A standard solution or a reference D.O. meter may be used to compare readings during calibration.

The calibration of the D.O. concentration range can only be performed at a single custom point (4 to 50 mg/L). It is recommended to calibrate the D.O. sensor close to the values that will be measured.

Choose "DO calibration" from the "Calibration" menu, select the D.O. calibration type using the arrow keys and press <Select> to confirm.

% D.O. saturation

The calibration of the % D.O. saturation range can be performed at a single or 2 standard points (0 % and 100 %), or at a single custom point (50 % to 500 %).

Procedure:

- To calibrate at 100 %, fill the calibration beaker with approximately 4 mm (5/32") of water and screw it onto the probe. The membrane should not be wet. This condition corresponds to air 100 % saturated with oxygen and water vapor.
- The reading, temperature, calibration point and the "Not ready" message are displayed.
- Once the reading has stabilized the countdown timer will count down until the display shows the "Ready" message.
- Press <Confirm> to accept the calibration point. After confirmation, put the D.O. and temperature sensors into HI 7040L zero oxygen solution and wait for stability to be reached. The stability timer will count down and <Confirm> will appear. Press <Confirm> to store the calibration.
- The following messages will appear: "Storing" and "Calibration completed".
- Press <OK> to return to the "Calibration" menu.
- Press ESC twice to return to the main menu.
- Press <Measure> to return to the measurement screen.

Note The user can perform a single point calibration by pressing <ESC> after the first point is accepted.

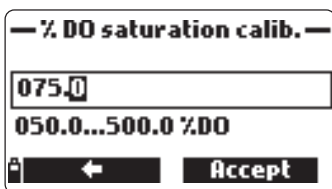
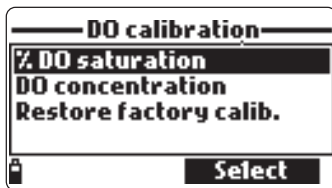

Note If the D.O. input is not within the acceptable range, the message “Invalid input” is displayed.

Single point Custom % saturation calibration

- For a calibration at another known value place sensor and temperature probe into the known solution and change the calibration value, press the <Cal. point> softkey and select the desired point.
- To insert a different calibration value, press <Cal. point> and then <Custom>. Insert the desired value using the keypad, then press <Accept>.
- When the reading is stable, the “Ready” message is displayed. Press <Confirm> to store the calibration point.
- The following messages will appear: “Storing” and “Calibration completed”.
- Press <OK> to return to the “Calibration” menu.
- Press ESC twice to return to the main menu.
- Press <Measure> to return to the measurement screen.

D.O. concentration

Verify the barometric pressure, conductivity and temperature reading are correct. Calibrate them if necessary. To calibrate the D.O. concentration range, a solution with known Dissolved Oxygen concentration value is needed. The solutions used to calibrate with should be determined independently (for instance by Winkler titration). Place the D.O. sensor with temperature sensor into the known solution.

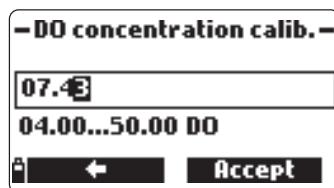

- From the “DO calibration” menu, select the “DO concentration” option, insert the known concentration. Allow the sensors to reach thermal equilibrium with the solution. Stir or agitate if possible to keep fresh solution in front of the membrane and press <OK>.
- When the reading is stable, the stability timer will count down and <Confirm> will appear. Press <Confirm> to accept the value.
- When the messages “Storing” and “Calibration completed” appear, the calibration is completed. To return to the “Calibration” menu, press <OK>.
- To return to the main menu, press ESC twice.

7.6 CONDUCTIVITY CALIBRATION

A conductivity calibration is used to adjust for variations in cell factors by using a standard solution of known conductivity. Oily coating and biological contaminants are the primary cause of calibration drift in conductivity sensors. This type of fouling changes the apparent cell geometry, resulting in a shift in cell constant. Before performing a conductivity calibration inspect the EC sensor for debris or blockages. The EC electrodes are situated inside the two small channels

found in the bottom of the conductivity sensor. Clean using the small brush from the probe maintenance kit. Flush with water. A mild detergent may be used to remove oily coatings. Always flush with clean water after cleaning.

Note For a correct conductivity calibration, the probe shield or the calibration beaker must be used.

The conductivity calibration menu includes 3 different types of calibration: Conductivity, Absolute conductivity and Salinity.

The "Conductivity" option allows a single point calibration with a standard solution selectable by the user. This calibration is temperature compensated.

The "Absolute conductivity" option allows a single point calibration with a conductivity solution of known non-temperature compensated value at the current temperature.

The "Salinity" option allows calibration with a standard salinity solution.

The 3 calibrations are related, so that each one will calibrate all 3 measurements.

Note To improve accuracy, choose a calibration standard near the sample conductivity.

Choose "Conductivity calibration" from the "Calibration" menu, select the calibration type using the arrow keys and press <Select> to confirm.

Conductivity

- Select the "Conductivity" option and press <Select> to confirm.
- Fill the calibration beaker with a conductivity standard (see APPENDIX D - "Accessories" for choosing the proper HANNA standard solution).
- Pour additional standard into a second beaker to be used to rinse the sensor.
- Immerse the sensor into the rinse standard by raising and lowering the beaker a few times to ensure that the EC sensor channels are filled with fresh standard.
- Place the calibration beaker over the EC sensor and dislodge any trapped bubbles. Screw the beaker into place. Wait for the reading to stabilize.

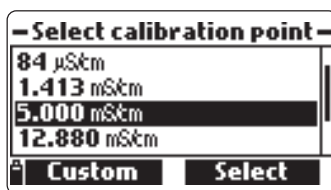
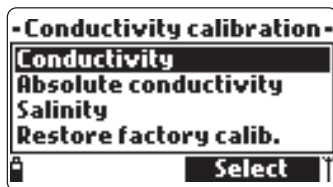

- The main display shows the actual reading, while the secondary level displays the current temperature and the standard value.
- To change the standard value, press <Cal. point> and the list of available standard values is displayed: 0 $\mu\text{S}/\text{cm}$, 84 $\mu\text{S}/\text{cm}$, 1413 $\mu\text{S}/\text{cm}$, 5.00 mS/cm , 12.88 mS/cm , 80.0 mS/cm and 111.8 mS/cm .
- The third level displays the status message.
- Press <Custom> to insert a custom value (temperature compensated value). Insert the desired value using the keypad, then press <Accept>.
- When the reading becomes stable, the stability timer will count down and <Confirm> will appear. Press <Confirm> to save the calibration.
- After confirmation, the following messages are displayed: "Storing" and "Calibration completed".
- Press <OK> to return to the "Calibration" menu.
- Press ESC twice to return to main menu.
- Press <Measure> to return to the measurement screen.

Absolute Conductivity

- Select "Absolute conductivity" from the "Conductivity calibration" menu.
- Use the keypad to enter the custom value with the desired resolution. Press <Accept> to confirm.
- Fill the calibration beaker with conductivity standard with known conductivity at the temperature of standardization.
- Pour additional standard into a second beaker to be used to rinse the sensor.
- Immerse the sensor into the rinse beaker and raise and lower the beaker to ensure that the EC sensor channels are filled with fresh standard.
- Place the calibration beaker over the EC sensor and dislodge any trapped bubbles. Screw the beaker into place.
- Wait for the reading to stabilize. The stability timer will count down and <Confirm> will appear.
- Note the temperature and adjust the conductivity value if needed.
- Press <Confirm> to save the calibration.
- After confirmation, the following messages are displayed: "Storing" and "Calibration completed".
- Press <OK> to return to the "Calibration" menu.
- Press ESC twice to return to the main menu.
- Press <Measure> to return to the measurement screen.

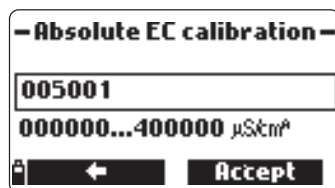

Salinity

The measurement of salinity is based on the Practical Salinity Scale which uses the EC measurement. If the user has a standard with known PSU value it may be used to calibrate the conductivity sensor.

- Select "Salinity" from the "Conductivity calibration" menu.
- Use the keypad to enter the known salinity value of the calibration solution. Press <Accept> to confirm.
- Fill the calibration beaker with salinity standard of known value.
- Pour additional standard into a second beaker to be used to rinse the sensor.
- Immerse the sensor into the rinse beaker and raise and lower the beaker to ensure that the EC sensor channels are filled with fresh standard.
- Place the calibration beaker with standard over the EC sensor and dislodge any trapped gas bubbles. Screw the beaker into place.
- Wait for the reading to stabilize. The stability timer will count down and <Confirm> will appear.
- Note the temperature and adjust the salinity value if needed.
- Press <Confirm> to save the calibration.
- After confirmation, the following messages are displayed: "Storing" and "Calibration completed".
- Press <OK> to return to the "Calibration" menu.
- Press ESC twice to return to the main menu.
- Press <Measure> to return to the measurement screen.

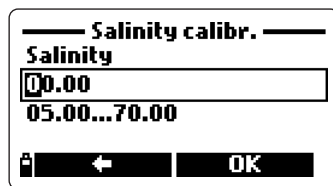

Notes These procedures calibrate the slope value. To calibrate the offset, set the calibration point at 0 $\mu\text{S}/\text{cm}$ and repeat the procedure.

If the temperature input is not within the acceptable range (0 to 50°C), the message "Invalid temperature" is displayed.

If the conductivity input is not within the acceptable range, the message "Wrong standard" is displayed.

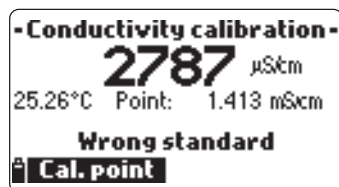

7.7 TURBIDITY CALIBRATION

From the "Calibration" menu select "Single param. calibration" and then "Turbidity calibration". The display shows two options: "Calibrate turbidity" and "Restore factory calib".

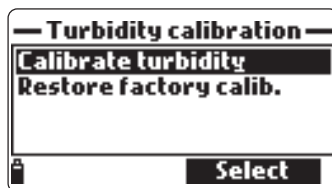

The Hanna turbidity sensor conforms to ISO 7027 standards which specifies the angle between the emitted and detected light and the light source wavelength. For best results perform a three point calibration at 0.0, 20.0, and 200.0 FNU. Although the basis of calibration for this measurement is the standard Formazin, from a practical point of view, these standards require daily preparation. A secondary standard based upon polystyrene beads is a more practical approach. See APPENDIX D – Accessories for information regarding Hanna calibration solutions.

Note Turbidity standard formulations made with polystyrene beads are instrument specific and cannot be swapped with standards made for another turbidity sensor model.

Verify the sensor is clean before calibrating. The use of the HI 7698293 calibration beaker is required for this procedure.

Calibration is required every time the sensor is replaced and is recommended to be part of yearly validation of your system.

7.7.1 Preparation

Pour quantities of selected standard solutions into clean beakers for rinse. Fill the HI 7698293 calibration beaker with the zero standard. Submerge the turbidity sensor into zero rinse beaker and then shake off excess solution. Place the sensor into the calibration beaker. It is extremely important that no bubbles are present on the optical area. Gentle agitation of sensor or beaker may be required to dislodge bubbles before screwing the beaker on fully.

7.7.2 Procedure

Select "Calibrate turbidity" from the menu.

The measured value is shown on the main part of the display, while the standard value appears on the secondary level.

- The current turbidity value, the standard value and "Not ready..." are displayed and a stability timer counts down.
- When the reading becomes stable, the display shows the "Ready" message.

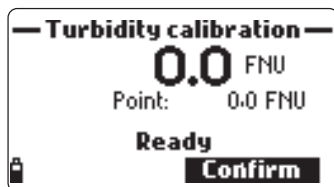

- Press <Confirm> to accept the calibration point and to continue with second standard.
- Clean out the calibration beaker and refill with 20.0 FNU standard.
- Immerse the sensor in the 20.0 FNU rinse beaker and then shake off excess solution. Place the sensor into the 20.0 FNU calibration beaker. Observe the precautions noted above for bubbles.

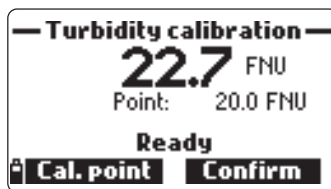

- When the reading is stable the display shows the “Ready” message.
- Press <Confirm> to accept the second calibration point and to continue with third standard.
- Clean out the calibration beaker and refill with 200.0 FNU standard.
- Immerse the sensor in the 200.0 FNU rinse beaker and then shake off excess solution. Place the sensor into the 200.0 FNU calibration beaker. Observe the precautions noted above for bubbles.

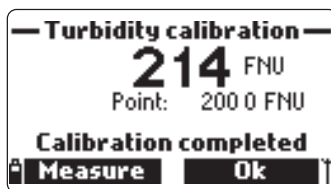

- When the reading is stable the display shows the “Ready” message.
- Press <Confirm> to accept the third point and save the calibration.
- After confirmation, the following messages are displayed: “Storing” and “Calibration completed”.
- Press <OK> to return to the “Calibration” menu.
- To return to the main menu, press ESC twice.
- Press <Measure> to return to the measurement screen.
- To restore the factory calibration data, select the corresponding option in the “Turbidity calibration” menu and then press <Select>.

Note The calibration procedure can be terminated after 1 or 2 points by pressing <ESC>. A single point calibration is only recommended to update the offset of a previous 2 or 3 point calibration. A 2 point calibration is only recommended when the expected turbidity readings are below 40 FNU.

7.8 TEMPERATURE CALIBRATION

The probe is factory calibrated for temperature readings. The user can perform a single point temperature calibration or restore factory calibration. This procedure requires a reference temperature measuring instrument.

- Select "Temperature" from the "Calibration" menu.
- Select "Calibrate temperature".
- Insert the probe in an isothermal bath with reference instrument and allow the probe to come to thermal equilibrium.
- Use the keypad to enter the known temperature and then press <Accept> to confirm.
- The stability timer will count down and the message "Ready" and <Confirm> will be displayed.
- Press <Confirm> to store the calibration point.
- After confirmation, the following messages are displayed "Storing" and "Calibration completed".
- Press <OK> to return to the "Calibration" menu.
- Press <Measure> to return to the measurement screen.
- To restore the factory calibration, select the corresponding option in the "Temperature calibr." menu and then press <Select>.

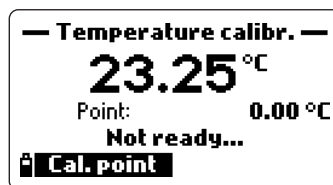
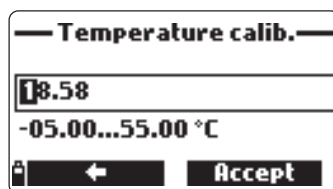

7.9 ATMOSPHERIC PRESSURE CALIBRATION

Place HI 9829 in a wind-free area and choose "Custom pressure" to perform a user calibration or "Restore factory calibr".

Note "Custom pressure" procedure requires a reference barometer.

Select the "Atm. pressure" from the "Calibration" menu.

- Select the "Custom pressure" option.
- Using the keypad, insert the numeric value that agrees with the reference meter and then press <Accept> to confirm.

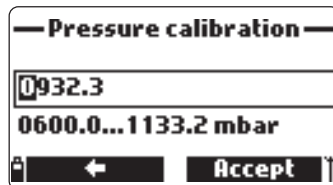
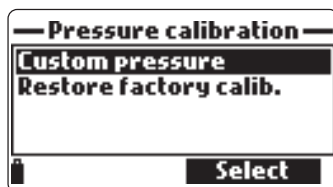

- The stability counter will count down and the message "Ready" and "Confirm" will be displayed. Press <Confirm> to store the calibration point.
- After confirmation, the following messages are displayed: "Storing" and "Calibration completed".
- Press <Measure> to return to the measurement screen.
- Press <OK> to return to the "Calibration" menu.
- To restore the factory calibration, select "Restore factory calib." in the "Pressure calibration" menu and press <Select>.

Chapter 8 - SYSTEM SETUP

From the main menu, select "System setup" and then "Meter setup" or "Probe setup".

8.1 METER SETUP

Note If the password protection is enabled, you will be required to enter the password before any settings can be modified.

8.1.1 Time

The meter uses a real time clock for logging. The time and time format are set in this function.

Press <Modify> and set the time using the keypad. Press <Accept> to save the time. When using the 12 hour format, press A or P on the keypad for AM or PM after you set the time.

Press <Format> to change between 12 and 24 hour formats. The default format is 24 hours.

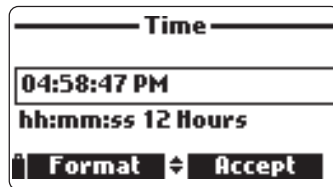
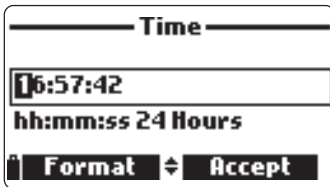
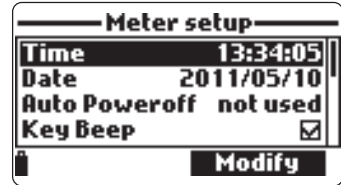
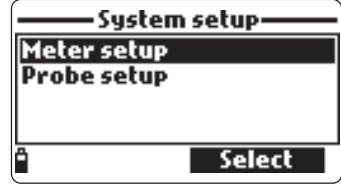
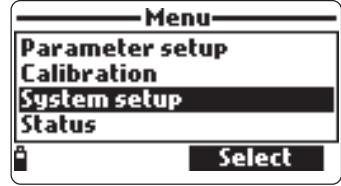

8.1.2 Date

The date and date format are set in this function. Press <Modify> and set the date using the keypad. Press <Accept> to save the date.

Press <Format> to change between the available date formats: DD/MM/YYYY, MM/DD/YYYY, YYYY/MM/DD, YYYY-MM-DD, MM-DD-YYYY, and DD-MM-YYYY. The default format is YYYY/MM/DD.

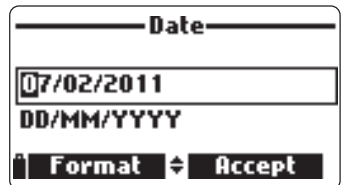

8.1.3 Auto Poweroff

The Auto Poweroff function is used to save battery life. After the set time is elapsed, the meter will:

1. automatically switch off, if in normal measurement mode. Press On/Off to switch on again.
2. enter a sleeping mode, if the continuous logging mode is selected with a logging interval of at least 30 seconds. The "Auto Poweroff" message and the <Wake up> softkey appear on the LCD; logging is not stopped. Press <Wake up> to reactivate the display.

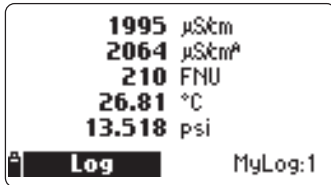
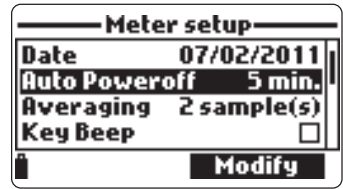

Available options are: Not used (disabled), 5, 10, 15, 20, 30 or 60 minutes. Press <Modify> to select the desired time interval. The default value is "not used".

8.1.4 Key Beep

If enabled, an acoustic signal sounds every time a key is pressed. A checked box indicates this function has been enabled. The default setting is disabled.

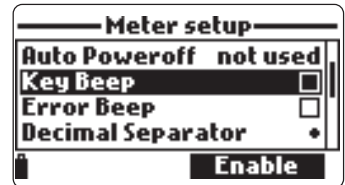

8.1.5 Error Beep

If enabled, an acoustic signal sounds every time an incorrect key is pressed, or when an error occurs. A checked box indicates this function has been enabled. The default setting is disabled.

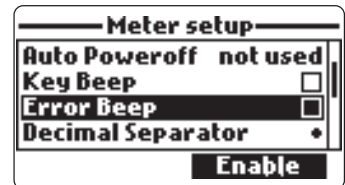

8.1.6 Decimal Separator

The user can select the type of decimal separator: "dot" or "comma". Press the softkey to select the desired option. The default setting is "dot".

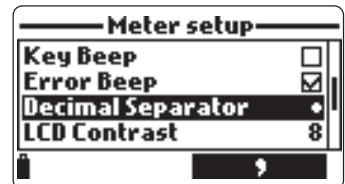

8.1.7 LCD Contrast

The LCD contrast can be adjusted with this function. Press <Modify> to enter this function. Use the arrow keys to change the contrast level and press <Accept> to save the new value. The default value is 8.

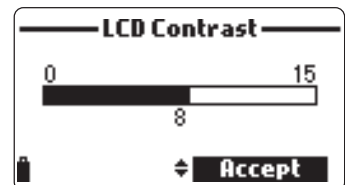

8.1.8 Meter Password

The Meter Password protects against unauthorized configuration changes and log data erasure. When implemented, many setting and functions cannot be modified or viewed.

To enable the password proceed as follows:

- Highlight “Meter Password” and press <Modify>.
- Enter the desired password in the text box and press <Accept>.



Note While typing, the characters are masked with a “*” (star) symbol.

- The meter will require password confirmation. Retype the same password and press <Accept> to confirm.
- The meter returns to the “Meter Setup” menu. The checkbox corresponding to the meter password is checked.

To disable the password protection highlight “Meter Password” and press <Modify>, enter the password and then press <Disable>. “No password” appears in the text box. Press <Accept> to confirm.

8.1.9 Meter ID

The Meter ID may be used to uniquely identify a meter/operator. Press <Modify> and a text box appears. Use the keypad to insert the desired alphanumeric ID and press <Accept> to store the identification. A maximum of 14 characters can be used.

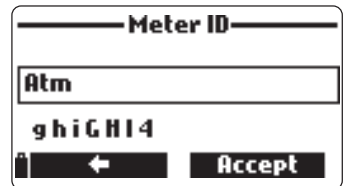

8.1.10 Language

The language used in the meter user interface can be changed. The default language is English. Please contact your local Hanna office for currently available languages.

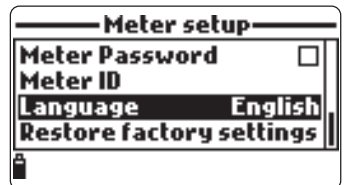

8.1.1.1 Restore factory settings

This function restores measurement settings to their original factory values. This includes measurement units, coefficients, other measurement configurations and all logged data. The factory calibration for the sensor channels is not affected.

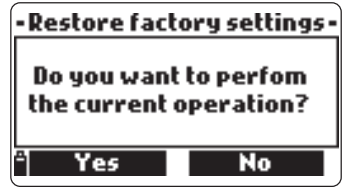

- Select the "Restore factory settings" and press <Select>.
- The meter will ask to confirm: press <Yes> to confirm or <No> to escape.

8.2 PROBE SETUP

8.2.1 Probe ID

The probe can be labeled with an identification code: press <Modify> and a text box will be displayed. Use the keypad to enter the desired alphanumeric code and then press <Accept>.

A maximum of 14 characters can be used.

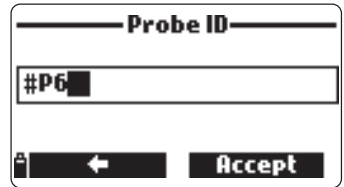

8.2.2 Probe Password

The Probe Password protects the probe against unauthorized configuration changes and log data erasure. When implemented, many setting and functions cannot be modified or viewed.

To enable the password:

- Highlight the "Probe Password" and press <Modify>.
- Enter the desired password in the text box and press <Accept>.

Note While typing, the characters are masked with "*" (star) symbols.



- The probe will require confirmation. Retype the same password and press <Accept> to confirm.
- The meter returns to the "Probe Setup" menu. The checkbox corresponding to the probe password is checked.

To disable the password, highlight the "Probe Password" and press <Modify>. Enter the password and then press <Disable>. "No password" appears in the text box. Press <Accept> to confirm.

Chapter 9 - GPS MENU (optional)

HI 9829 model featuring GPS (Global Positioning System) is provided with a built-in 12 channel receiver and antenna to calculate meter position and track locations along with measurement data.

The GPS has a position accuracy of 10 meters (30 ft).

The GPS coordinates can be shown on the LCD together with up to 10 measurement parameters, and are recorded with logged data.

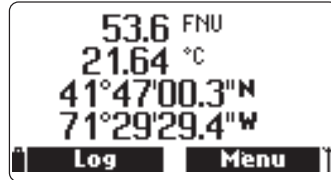

The GPS signal strength is always displayed through a 3 length antenna indicator on the bottom right corner of the LCD. If the antenna symbol is blinking, the satellite acquisition is not yet completed or the signal strength is not sufficient. Signal strength can be improved by moving outdoors and away from buildings and trees.

The user can associate GPS coordinates with alphanumeric locations, which will be assigned to the logged data.

- To enter the GPS menu, press <Menu> from measurement mode and select "GPS menu".

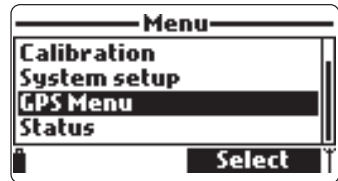

All locations / Nearby locations

These options display all stored locations. Selecting "Nearby locations" will filter out locations that are further than 100 km (or 100 mi) from the current location. If a GPS signal has been obtained, the distance from the current position to the nearby locations is also displayed.



Press <Info> to view the GPS coordinates of the selected location. Press <Delete> to erase the selected location.

Press <New> to add a new location. Coordinates for a new location can be entered manually or by using the current GPS coordinates.

Clear all locations

This option deletes all locations. The meter will ask for confirmation before proceeding, by displaying the message "All location information will be erased. Continue?".

Press <Yes> to confirm deletion or <No> to return to the previous screen.

GPS powersave

This feature saves battery life by automatically switching the GPS unit off when the meter is in continuous logging mode with a logging interval of at least 4 minutes. The GPS unit will turn off after each measurement and turn on again 3 minutes before the next measurement is taken.

If the GPS unit cannot obtain a position fix within two minutes, it will keep the GPS on by disabling the powersave feature.

GPS status

This screen displays the following GPS information: latitude and longitude of the current position, number of acquired satellites, time elapsed since last detected position (if the GPS signal is not currently available).

Pressing <GPS OFF> will disable the GPS unit.

Pressing <GPS ON> will enable the GPS unit and show the GPS receiver model and version.

Since the power consumption of the GPS unit is significant, it is recommended to turn the GPS unit off when it is not needed.

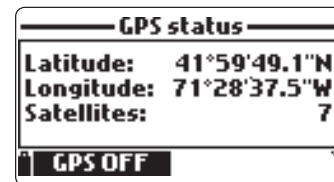
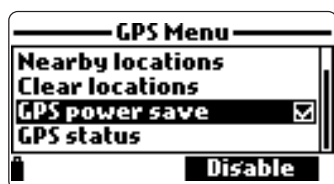
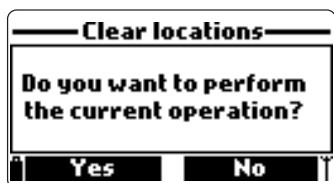
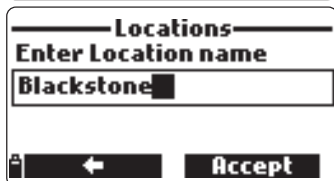
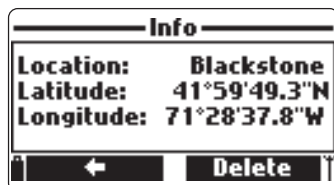

Chapter 10 - STATUS

Useful information regarding the meter, probe (if connected) and GLP calibration data are available for viewing by selecting "Status" from the main menu.

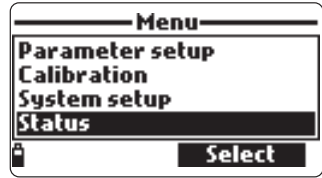

10.1 METER STATUS

Select "Meter Status" to display information related to the battery, logging, internal temperature, password, Meter ID, serial number and firmware version. Press [up] and [down] to scroll through the status screens. Press ESC to return to the "Status" menu.

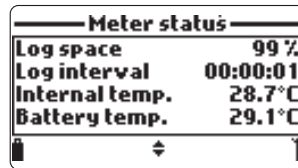
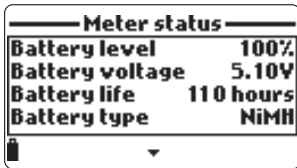
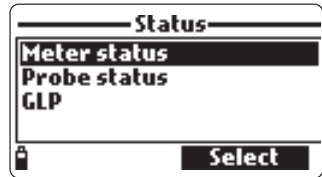

10.2 PROBE STATUS

Select "Probe Status" to display information related to the probe type, connected sensors, battery level, logging (if logging probe), password, Probe ID, serial number and firmware version.

- Press [up] and [down] to scroll through the status screens.
- Press ESC to return to the "Status" menu.

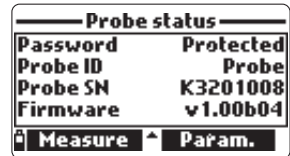
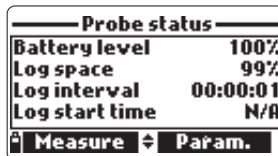
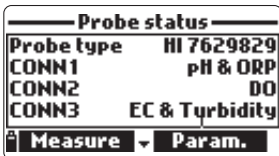
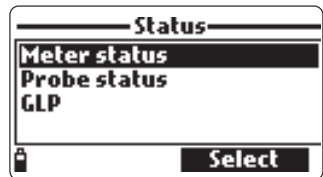

Note The probe status screen will automatically be displayed when the probe sensor status has changed. If this occurs, the "Measurement Screen" and "Parameter Selection" softkeys are available (see Section 5.2).

10.3 GLP Data

GLP (Good Laboratory Practice) is a set of functions that allows the user to store or recall data regarding the probe calibration. This feature also allows the user to associate readings with specific calibrations.

To view GLP data select "GLP" from the "Status" menu. The complete list of available parameters appears. Select the desired parameter to view the stored GLP information.

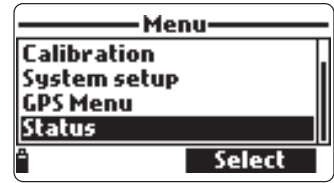

Note If no calibration data is available for the selected parameter, the display shows the message "No GLP data available for this measurement". Press <OK> to return to the previous screen.

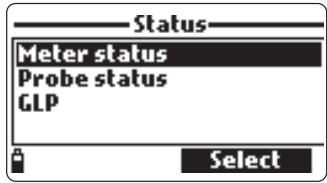

Note GLP data is stored for the last 5 calibrations. This calibration history allows the user to detect when readings start to change and sensors may require cleaning or replacement.

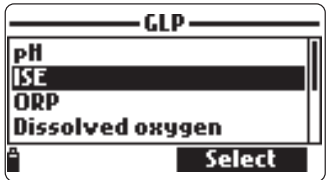

pH

- From the "GLP" menu, select the "pH" option.
- Data regarding the last pH calibration will be displayed: offset, acidic slope, basic slope, buffers used, time and date of the calibration.
- Use the arrow keys to scroll through the stored data for the last 5 calibrations.
- Press ESC to return to the "GLP" menu.

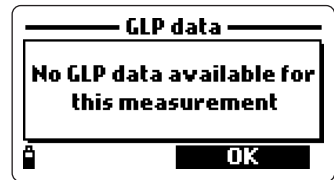

Note A "C" label near the buffer value indicates a custom point, while an "H" indicates a HANNA standard buffer value.

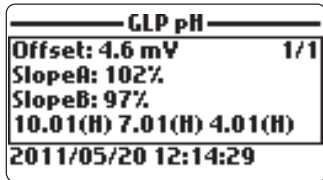

If a quick calibration was performed, the buffer values are replaced with the "Quick calibration" indication.

If no pH calibration has been performed or if calibration was cleared using the the "Restore factory calib." option the offset and slope values are set to default, and the message "Factory calibration" is displayed. Press <ESC> to return to the previous screen.

ISE

- From the "GLP" menu, select the "ISE" option.
- Data regarding the last ISE calibration will be displayed: standards used, sensor type, time and date of the calibration.
- Use the arrow keys to scroll through the stored data for the last 5 calibrations.
- Press ESC to return to the "GLP" menu.

GLP ISE		
Point 1:	10.0 ppm	2/3
Point 2:	100.0 ppm	
Chloride		
2011/02/11 12:54:27		

Notes If no ISE calibration has been performed or if calibration was cleared using the "Restore factory calib." option the offset and slope values are set to default, and the message "Factory calibration" is displayed. Press <ESC> to return to the previous screen.

ORP

- From the "GLP" menu select the "ORP" option.
- Data regarding the last ORP calibration will be displayed: calibration point, time and date.
- Use the arrow keys to scroll through the stored data for the last 5 calibrations.
- Press ESC to return to the "GLP" menu.

GLP ORP	
Point:	-218.4 mVORP 1/1
2011/05/23 16:49:49	

Notes If no ORP calibration has been performed or if calibration was cleared using the "Restore factory calib." option the offset and slope values are set to default, and the message "Factory calibration" is displayed. Press <ESC> to return to the previous screen.

Dissolved Oxygen

- From the "GLP" menu select the "Dissolved oxygen" option.
- Data regarding the last D.O. calibration will be displayed: calibration points, % saturation or concentration, time and date.
- Use the arrow keys to scroll through the stored data for the last 5 calibrations.

GLP DO		
Point 1:	100.0 %DO	1/5
Point 2:	0.0 %DO	
% DO saturation (H)		
2011/04/19 17:49:50		

Notes A "C" label near the calibration point indicates a custom point, while an "H" indicates a HANNA standard value.

When the % D.O. range is calibrated, also the D.O. concentration range is calibrated, and vice versa.

If no D.O. calibration has been performed or if calibration was cleared using the "Restore factory calib." option the offset and slope values are set to default, and the message "Factory calibration" is displayed. Press <ESC> to return to the previous screen.

Conductivity

- From the "GLP" menu select the "Conductivity" option.
- Data regarding the last conductivity calibration will be displayed: calibration point, cell constant value, calibration type (conductivity, absolute conductivity or salinity), time and date of the calibration.
- Use the arrow keys to scroll through the stored data for the last 5 calibrations.

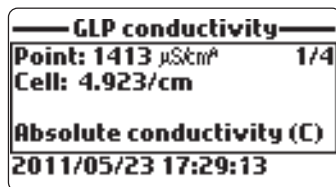
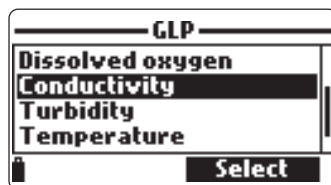

Notes A "C" letter near the conductivity calibration indicates a custom point, while an "H" indicates a HANNA standard value.

If no conductivity calibration has been performed or if calibration was cleared using the "Restore factory calib." option the offset and slope values are set to default, and the message "Factory calibration" is displayed. Press <ESC> to return to the previous screen.

Turbidity

- From the "GLP" menu select the "Turbidity" option.
- Data regarding the last turbidity calibration will be displayed: standards used, time and date of the calibration.
- Use the arrow keys to scroll through the stored data for the last 5 calibrations.
- Press <ESC> to return to the "GLP" menu.

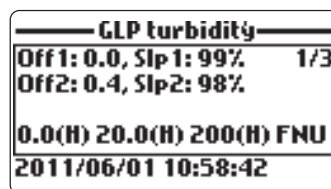

Notes If no turbidity calibration has been performed or if calibration was cleared using the "Restore factory calib." option the offset and slope values are set to default, and the message "Factory calibration" is displayed. Press <ESC> to return to the previous screen.

Temperature

- From the "GLP" menu select the "Temperature" option.
- Data regarding the last temperature calibration will be displayed: calibrated point, time and date.
- Use the arrow keys to scroll through the stored data for the last 5 calibrations.



Notes If no user temperature calibration has been performed or if calibration was cleared using the "Restore factory calib." option the offset value is set to default, and the message "Factory calibration" is displayed. Press <ESC> to return to the previous screen.

Atmospheric Pressure

- From the "GLP" menu select "Atm. pressure".
- Data regarding the last atmospheric pressure calibration will be displayed: custom calibration point, time and date.
- Use the arrow keys to scroll through the stored data for the last 5 calibrations.

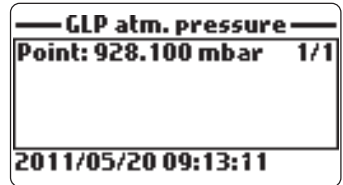

Notes If no atmospheric pressure calibration has been performed or if calibration was cleared using the "Restore factory calib." option the offset value is set to default, and the message "Factory calibration" is displayed. Press <ESC> to return to the previous screen.

Chapter 11 - LOGGING MODE

The HI 9829 and HI 76x9829 system offers many logging options that can be combined based on user needs. The following figures describe the available logging options.

Logging on meter

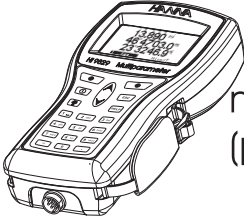

meter parameters only
(pressure, GPS)

Or

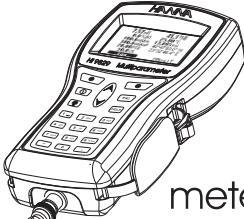

meter & probe parameters

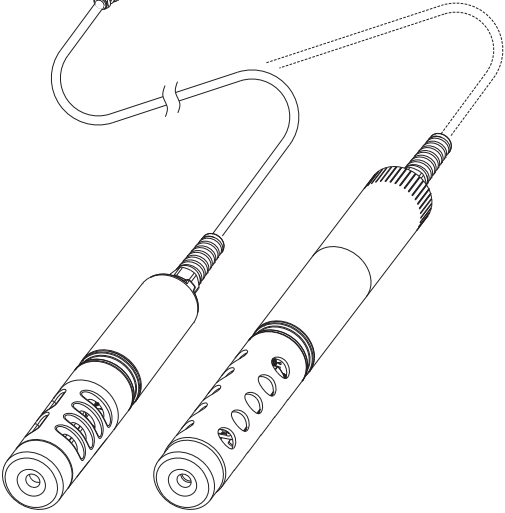

Logging on probe (HI 7629829 & HI 7639829 only)

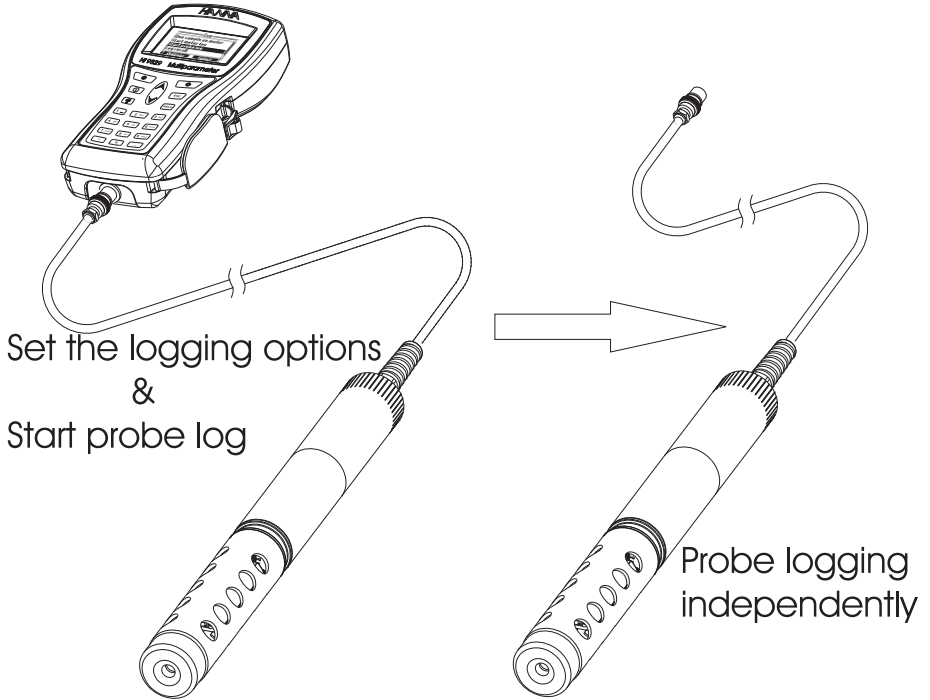

11.1 LOGGING MENU STRUCTURE

From measurement mode, press <Log> to access the log menu.

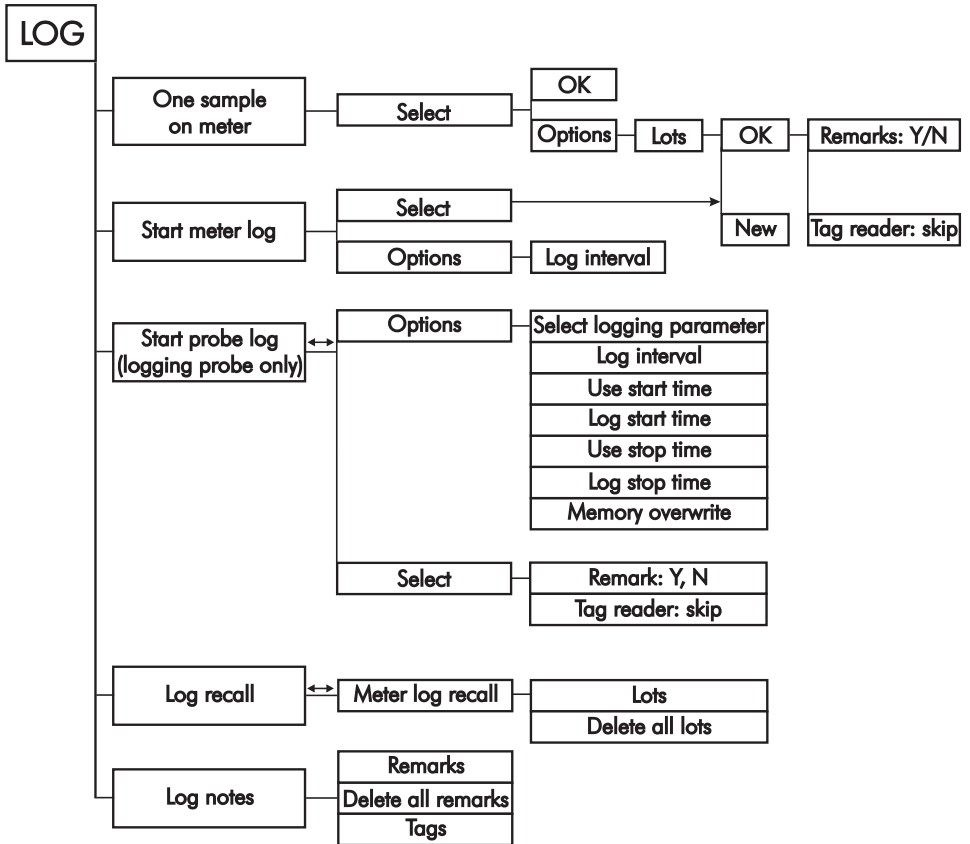

11.2 LOGGING ON METER

- The data logged on the meter are organized by lots. Up to 44,000 complete records can be stored in up to 100 lots. Each lot can store log-on-demand records and/or continuous records with different parameter configurations.

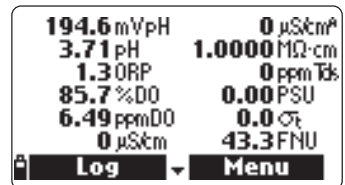

11.2.1 One Sample On Meter

Use this option to log one set of enabled measurement parameters to the meter memory.

- If there are no lots saved on the meter, press <New> to create a new lot. Use the keypad to enter the desired lot name and press <Accept> to confirm. Press <OK> to log the sample in the selected lot.

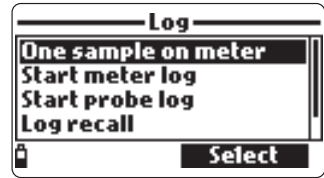

- If there are existing lots on the meter, the meter will suggest a lot to store the sample. Press <OK> to use the selected lot or <Options> to select a different lot. This will add the new sample data to an existing lot. A new lot can also be created by pressing <New>. Press <OK> to log the sample in the selected lot.

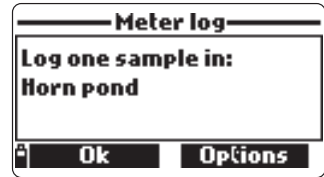

- On the "Remarks" window, select <Yes> to go to the Remarks screen. Press <No> to skip this option. If <Yes> is selected, select a remark from the list, or press <New> to create a new remark.



- On the "Read tag" screen, touch the location's iButton® with the meter's tag reader. Otherwise, press <Skip> to skip this option.



- If the tag is touched, the associated ID will be displayed. If no ID is associated to the tag, the serial number is shown.
- Press <Tag ID> to insert an identification code for the tag, then press <OK>.
- To return to the measurement screen, press ESC.

11.2.2 Continuous meter log

- Select “Start meter log” to log the currently enabled parameters at the set logging interval on the meter.
- To set the logging interval, highlight “Start meter log” and press <Options>. The log interval time can set from 1 second to 3 hours. Press <Modify> and use the arrow keys and keypad to enter the desired log interval. Press <Accept> to confirm.
- Press <Select> to edit the lot, remark, or tag, see section 11.4.
- To stop the meter log, enter the log menu and select <Stop meter log> .

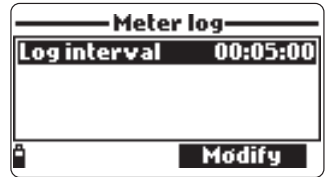
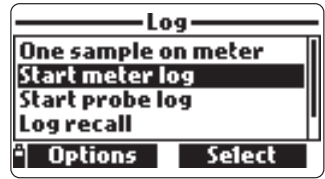

11.3 PROBE LOG (only for logging probes)

- Select “Start probe log” to start a log with the current settings. Press <Options> to change the log settings.

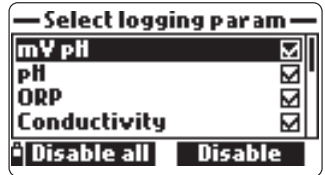
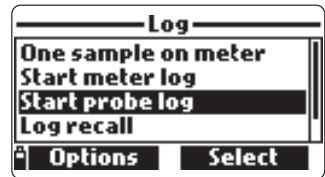

Probe Log Options

- To edit the lot remark, or tag, see section 11.5.
- The log interval time can be set from 1 second to 3 hours. Press <Modify> to change the logging interval. Press <Accept> to confirm.
- “Select logging param.” to modify the parameters to be logged.
- To specify the log start time, highlight “Use start time” and press <Enable>. Highlight “Log start time” and press “Select”. Enter the desired time and press <Accept> to confirm.
- To specify the log stop time, highlight “Use stop time” and press <Enable>. Highlight “Log stop time” and press <Select>. Enter the desired time and press <Accept> to confirm.

11.4 LOG RECALL

- All logged data can be viewed using two log recall options. The data logged on probe can be accessed only if the probe is connected to the meter or to the HI 929829 PC application by using the “Probe log recall” option. The probe logs that have already been downloaded to the meter and the data logged on the meter can be viewed using the “Meter log recall” option.

11.4.1 Meter log recall

- Select “Meter log recall” to view logs that are stored on the meter. The meter will show the number of available lots. Select “Lots” to view or delete individual lots.
- Use the arrow keys to select the desired lot and then press <View>.
- The meter displays a summary of all data related to the selected lot: number of samples, memory space used, time and date of the first and last readings.
- Press <View> to display the sample details for each point. Use the arrow keys to change the sample number in the selected lot. The sample number is shown on the bottom right corner of the display.

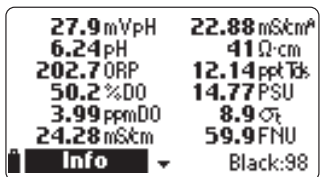
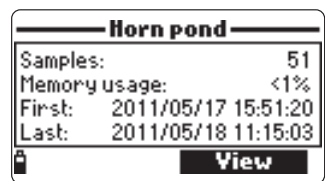
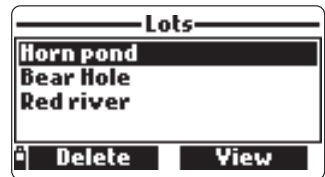
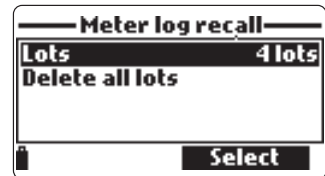
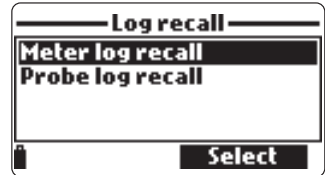

Note Details are available only for the enabled parameters.

- Press <Info> to see record information for the current sample (time & date, remark, location (only for model with GPS) and tag ID or serial number (if available).)
- Press <Data> to return to the previous screen or <Jump> to select a different sample in the same lot. When <Jump> is pressed, a text box appears to insert the desired sample number.
- Press ESC to return to the menu.
- Choose "Plot" and the meter will create a list with all available parameters that can be plotted.
- Use the arrow keys to select the desired parameter. Press <Select> to view the graph.
- Use the arrow keys to move the cursor in the graph and highlight a sample. The sample data are displayed below the graph.
- Press ESC to return to the parameter list.
- Press ESC again to return to the menu.

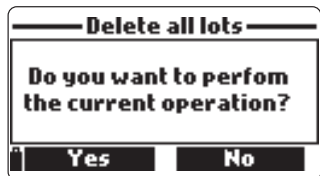
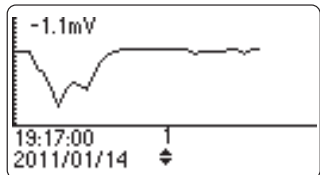
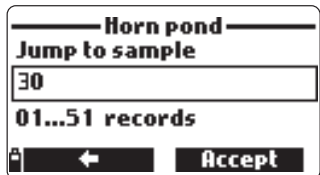
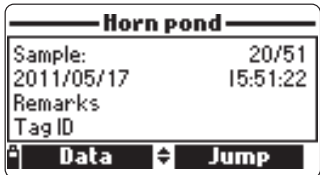

Note The number of lot samples that can be plotted is limited by the display resolution. To view a complete graph download data to PC.

Delete all lots

- From "Meter log recall" choose "Delete all lots" and the meter will display the message "Do you want to perform the current operation?". Press <Yes> to delete or <No> to return to the previous screen.
- To return to the "Log recall" menu, press ESC.

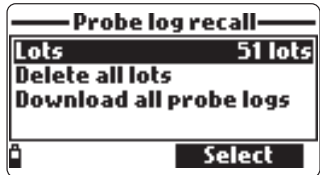

11.4.2 Probe log recall (Logging Probe only)

- Select "Probe log recall" to view and manage lots that are stored on the probe.
- Select "Lots" to display a list of available lots on the probe (logs have a Plog prefix).
- To view basic information about the highlighted lot, press <View>.

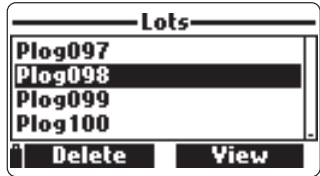

- After <View> is pressed, the meter displays all data related to the selected lot: number of samples, memory space used, time and date of the first and the last readings.
- To see all the sample details press <Download>. When the download is completed, the log is now stored on the meter and can be accessed from the "Meterlogrecall" menu. The data can be viewed as described in "Meter log recall" in section 11.4.1.
- The downloaded lots are not deleted from the probe and are available for other downloads (e.g. HI 929829 PC application).
- If a probe log has been downloaded to the meter, a warning message will be displayed if you try to download it again.

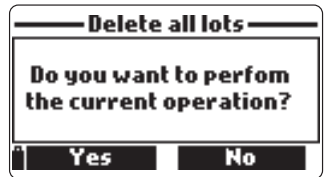
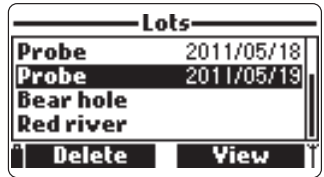

Delete all lots

- From "Probe log recall", select "Delete all lots" and the meter will display the message "Do you want to perform the current operation?". Press <Yes> to delete or <No> to return to the previous screen.
- To return to the "Log recall" menu, press ESC.

Download all probe logs

- From "Probe log recall", select "Download all probe logs". The meter will download all lots to the meter.

11.5 LOG NOTES

11.5.1 Remarks

A remark can be associated with each sample. The meter can store up to 20 remarks.

- To add a remark, select "Log notes" from the Log menu, and then select "Remarks".
- The display shows a list of stored remarks.
- Press <New> to create a new remark, and use the keypad to enter the new remark in the text box.

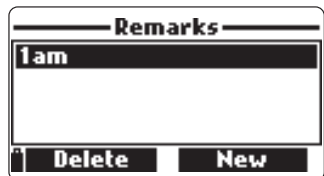
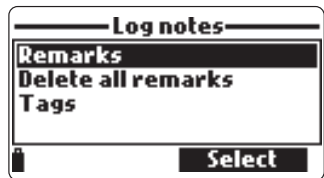

- Press <Delete> to delete the selected remark from the meter. If the deleted remark is used in an existing lot, the information will be still available in the lot data.

11.5.2 Delete all remarks

- Select “Delete all remarks” to delete all remarks. The display will show the message “Do you want to perform the current operation?”. Press <Yes> to delete or <No> to return to the previous screen.

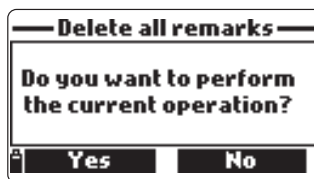
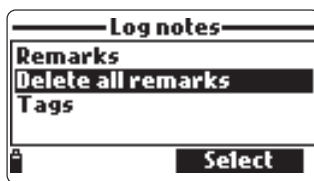

11.5.3 Tag Identification System

iButton® tags can be installed at sampling sites to simplify data logging. Tags have a unique serial number and a user-entered alphanumeric tag identifier. When the matching connector on the meter contacts the tag, logged measurements are labeled with the tag serial number and tag identifier. Tag configuration is accessed through the Log menu.

Readtag

- Select the “Read tag” option to view and modify the information associated with tag, or to insert new tag IDs.
- The display shows the message “Touch the tag with the tag reader”. Touch the tag with the tag reader located on the top of the meter.
- When the tag is detected the meter displays the tag serial number and ID (if available).



- Press <Tag ID> to insert a new ID (available only if the tag has not been previously identified).
- Press <Modify> to change the tag identifier or <OK> to close the window.

Search SN

- Select “Search SN” to search for a tag by serial number.
- Insert the serial number using the meter keypad and then press <Accept>.

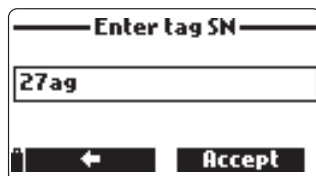

- The tag information window will appear. Press <OK> to return to the previous screen or <Modify> to modify the tag ID.

Note If the typed SN is not stored in memory, the warning message “SN not found” will be displayed.

Search ID

- Select “Search ID” to search for a tag by ID.
- Enter the identification code using the meter keypad and then press <Accept>.
- The tag information window will appear. Press <OK> to return to the previous screen or <Modify> to modify the tag ID.

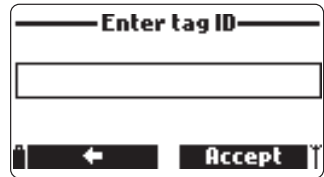

Note If the inserted ID is not present in memory, a warning message will be displayed.

Add tag manually

- Select “Add tag manually” to enter an ID code for a tag without using the tag reader (e.g. if the tag is not physically available).
- Enter the tag serial number using the meter keypad and then press <OK>.
- Enter the ID code for the tag and then press <OK>.
- The meter will now display the new tag information.

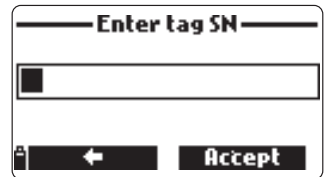

Clear tag memory

- Select “Clear tag memory” to clear all tag information from the meter memory.

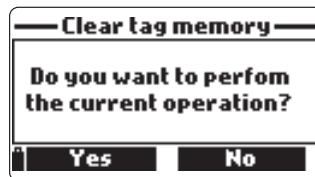

- The message “Do you want to perform the current operation?” appears.
- Press <Yes> to confirm or <No> to return to the previous screen.
- To return to measurement mode, press ESC.

Chapter 12 - PC CONNECTION MODE

The logged data from a probe or meter can be transferred to a PC using the HI 929829 Windows® compatible application software. HI 929829 offers a variety of features and on-line-help is available.

HI 929829 allows data to be imported into most spreadsheet programs (e.g. Excel®, Lotus 1-2-3®). After the data has been imported into a spreadsheet, all features of the spreadsheet program can be used to analyze and graph the data.

HI 929829 will automatically generate a map for samples logged with GPS coordinates. HI 929829 uses an external GPS tracking software such as Google™ Maps to view locations where measurements have been taken, therefore an internet connection is required to use this function.

12.1 SOFTWARE INSTALLATION

- Insert the installation CD into the PC.
- The software menu window should start automatically (if it does not, navigate to the main CD folder and double-click “hi929829start.exe”). Click “Install software” and follow the instructions.

12.2 METER TO PC CONNECTION

- With the meter OFF, disconnect the probe.
- Connect the HI 7698291 USB adapter to the meter and to a USB port on the PC.
- Turn the meter ON and the message “PC connected” will be displayed.
- Run the HI 929829 application software.
- Press Setting button on the top of the screen and select the measurement units you wish your data to appear with.
- To access the meter data select the “Meter” button on the toolbar at the top of the screen. The PC-Meter connection will be established and a new window will be displayed with meter data: status information (software version and date, SN, ID, GPS info, battery level and free memory info), as well as a summary of logged data lots. Both lots logged directly on the meter as well as lots logged on a probe and downloaded to the meter can be saved to the PC by pressing the “Download lot” button after the desired lot is selected.
- Once the lot has been downloaded, all the logged samples can be viewed.

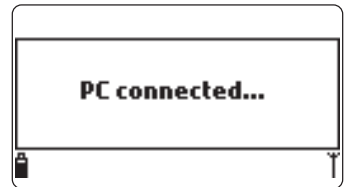

Windows® is a registered Trademark of “Microsoft Co.”

GOOGLE™ is a registered trademark of Google, Inc. HANNA instruments® has no affiliation with Google™, Inc.

Meter to PC data

- a. Select parameter units
- b. Select Meter from toolbar
- c. Select Lot
- d. Select Map

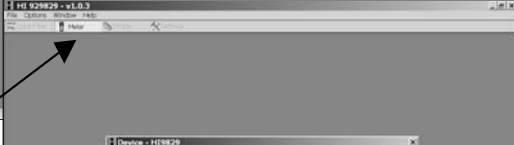
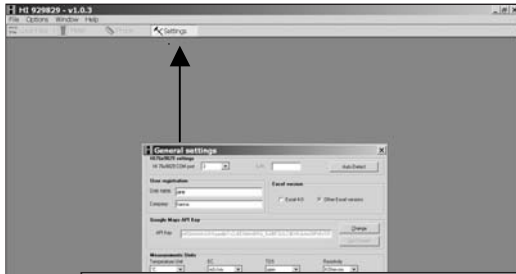

	Date	Time	Temp. [C]	pH	OPP [µV]
1	2011.06.08	18:42:17	24.84	6.27	45.4
2	2011.06.08	18:42:22	24.84	6.27	45.4
3	2011.06.08	18:42:27	24.78	6.29	46.2
4	2011.06.08	18:42:32	24.73	6.25	43.6
5	2011.06.08	18:42:37	28.80	7.38	12.9
6	2011.06.08	18:42:42	29.66	7.38	12.3
7	2011.06.08	18:42:47	29.71	7.41	12.2
8	2011.06.08	18:42:52	29.73	7.45	13.1
9	2011.06.08	18:42:57	29.78	7.49	13.4
10	2011.06.08	18:43:02	29.54	7.45	17.3
11	2011.06.08	18:43:07	29.73	7.58	14.4
12	2011.06.08	18:43:12	29.76	7.60	14.6
13	2011.06.08	18:43:17	29.76	7.62	14.7
14	2011.06.08	18:43:22	29.75	7.63	15.0
15	2011.06.08	18:43:27	29.73	7.63	15.8
16	2011.06.08	18:43:32	29.74	7.64	16.1
17	2011.06.08	18:43:37	29.74	7.65	16.2
18	2011.06.08	18:43:42	29.73	7.66	16.4
19	2011.06.08	18:43:47	29.70	7.68	17.3
20	2011.06.08	18:43:52	29.72	7.67	17.0
21	2011.06.08	18:43:57	29.73	7.68	17.0
22	2011.06.08	18:44:02	29.71	7.68	17.2

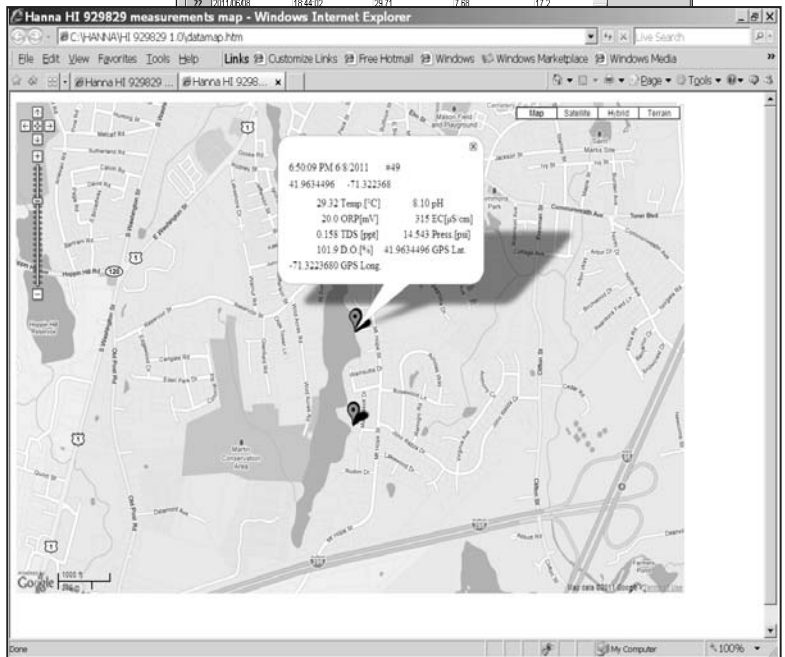

12.3 PROBE TO PC CONNECTION

- Connect the HI 76982910 adapter to the probe and to a USB port on the PC.
- Run the HI 929829 application software.
- To access the probe, press the “Probe” button from the toolbar on the top of the screen.
- A Communication Settings window will open. Select the correct COM port and press OK.

Note The Windows “Device Manager” can be used to verify which COM port number is used for connecting to the probe. Press START on the Windows® task bar and select “Control panel”. In the Control Panel select “System”, “Hardware”, “Device Manager”, “Ports”. The Ports menu shows the number of the virtual COM port associated with the HI 76982910 USB adapter.

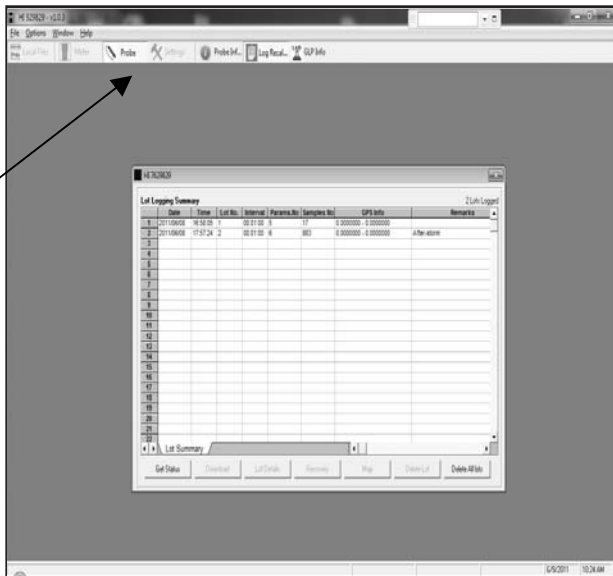

- Once the PC-Probe connection has been established a new window is displayed with probe data: status information (software version, SN, Connector Status, Available Parameters, Password Protection and free memory info) as well as available data lots.
- Select the desired lot and Press the “Download” button to download the data to the PC.
- Press the “GLP Info” button to get the probe GLP info.

Probe Info Screen

Measurement log data - Lot No. 2

Type: H 7C2629 Model: 101 v1.0304.4

41	Lot No.	2	After-Alarm
42	Version	101	
43	Started Date and Time	2011.06.08 - 17:57:24	
44	Stopped Date and Time	2011.06.09 - 08:43:24	
45	Delay to Start	00:00:00	
46	Delay to Stop	00:00:00	
47	Lampes No.	803	
48	Store Mode	Checked Overwrite Records	
49	Delay to Start	Disabled	
50	Delay to Stop	Disabled	
51	Record Size	23	
52	Battery Charge	2%	
53	Logging Interval	00:01:00	
54	Enabled Parameters to Log		
55	Parameter 1	Temp (°F)	
56	Parameter 2	ECp(S/cm)	
57	Parameter 3	TDS (µm/s)	
58	Parameter 4	D.O. (%)	
59	Parameter 5	pH(°C)	
60	Parameter 6	pH(°F)	
61	Parameters No.	6	
62	End Log Condition	Log Stopped By User	
63	GPS Coordinates (Lat. - Long.)	0.000000 - 0.000000	
64	Tag ID	0000000000	
65	LOT DATA		
66	EC CALIBRATION		
67	User Calibration	Point 1	10.00 - manna
68	Date & Time	06/09/11 - 9:53:58 AM	
69	EC CALIBRATION		
70	User Calibration	Conductivity	1.413 µS/cm - manna
71	Cell Constant	3.529 cm	
72	Date & Time	06/09/11 - 8:54:17 AM	
73	D.O. CALIBRATION		
74	User Calibration	Saturation	100.0 % (p.O.) - manna
75	Date & Time	06/09/11 - 9:53:40 AM	
76	Checksum	13434881	

Probe Info | Log data 1

Lot Data Screen

Measurement log data - Lot No. 2

Type: H 7C2629 Model: 101 v1.0304.4

#	Date	Time	Temp (°F)	ECp(S/cm)	TDS (µm/s)	D.O.(%)	pH(°C)	pH(°F)	Remarks
1	2011.06.08	17:57:24	73.48	1420.000	714.000	80.0	8.0	8.0	
2	2011.06.08	17:58:24	72.27	1421.000	710.000	84.5	8.0	5.99	
3	2011.06.08	17:59:24	73.23	1421.000	714.000	84.4	8.0	5.99	
4	2011.06.08	18:00:24	73.24	1421.000	710.000	83.0	8.0	5.99	
5	2011.06.08	18:01:24	72.89	1423.000	717.000	82.9	8.0	5.99	
6	2011.06.08	18:02:24	72.96	1425.000	718.000	82.4	8.0	5.99	
7	2011.06.08	18:03:24	72.91	1428.000	710.000	81.9	8.0	6.01	
8	2011.06.08	18:04:24	73.03	1427.000	714.000	81.4	8.0	5.99	
9	2011.06.08	18:05:24	72.88	1426.000	718.000	81.0	8.0	5.99	
10	2011.06.08	18:06:24	72.85	1426.000	710.000	80.2	8.0	5.99	
11	2011.06.08	18:07:24	73.25	1421.000	714.000	80.0	8.0	5.99	
12	2011.06.08	18:08:24	73.56	1420.000	712.000	80.1	8.0	5.99	
13	2011.06.08	18:09:24	73.03	1422.000	711.000	80.4	8.0	5.99	
14	2011.06.08	18:10:24	74.05	1413.000	709.000	87.0	8.0	5.99	
15	2011.06.08	18:11:24	74.22	1410.000	709.000	87.4	8.0	5.99	
16	2011.06.08	18:12:24	74.40	1413.000	707.000	87.1	8.0	5.99	
17	2011.06.08	18:13:24	74.53	1411.000	706.000	86.7	10.0	5.99	
18	2011.06.08	18:14:24	74.80	1400.000	709.000	86.4	10.0	6.01	
19	2011.06.08	18:15:24	74.63	1400.000	703.000	86.2	10.0	5.99	
20	2011.06.08	18:16:24	74.95	1405.000	703.000	86.0	10.0	5.99	
21	2011.06.08	18:17:24	75.09	1402.000	701.000	85.0	10.0	5.99	
22	2011.06.08	18:18:24	75.23	1400.000	705.000	85.5	10.1	5.99	
23	2011.06.08	18:19:24	76.30	1390.000	700.000	85.3	10.1	5.99	
24	2011.06.08	18:20:24	75.47	1390.000	690.000	85.3	10.1	5.99	
25	2011.06.08	18:21:24	76.52	1390.000	690.000	85.1	10.1	5.99	
26	2011.06.08	18:22:24	76.60	1395.000	690.000	85.0	10.1	5.99	
27	2011.06.08	18:23:24	76.67	1394.000	697.000	84.9	10.1	5.99	
28	2011.06.08	18:24:24	76.73	1390.000	697.000	84.9	10.1	5.99	
29	2011.06.08	18:25:24	76.72	1393.000	697.000	84.7	10.1	5.99	
30	2011.06.08	18:26:24	76.65	1394.000	697.000	84.7	10.1	5.95	
31	2011.06.08	18:27:24	76.50	1395.000	690.000	84.0	10.1	5.99	
32	2011.06.08	18:28:24	76.48	1390.000	694.000	84.8	10.1	5.99	
33	2011.06.08	18:29:24	76.38	1390.000	700.000	84.9	10.1	5.99	
34	2011.06.08	18:30:24	76.05	1405.000	702.000	85.0	10.1	5.99	
35	2011.06.08	18:31:24	74.96	1405.000	710.000	85.2	10.0	5.99	
36	2011.06.08	18:32:24	74.74	1400.000	704.000	85.4	10.0	5.95	
37	2011.06.08	18:33:24	74.28	1414.000	705.000	85.5	10.0	5.99	
38	2011.06.08	18:34:24	73.82	1421.000	711.000	86.1	9.9	5.95	
39	2011.06.08	18:35:24	72.87	1421.000	711.000	86.3	9.9	5.99	
40	2011.06.08	18:36:24	73.85	1424.000	707.000	86.2	9.9	5.99	
41	2011.06.08	18:37:24	73.36	1420.000	710.000	86.4	9.9	5.99	
42	2011.06.08	18:38:24	72.30	1420.000	710.000	86.7	9.9	5.99	
43	2011.06.08	18:39:24	73.54	1424.000	710.000	86.6	9.8	5.95	
44	2011.06.08	18:40:24	72.99	1430.000	710.000	86.8	9.9	5.99	
45	2011.06.08	18:41:24	73.09	1428.000	710.000	86.8	9.9	5.99	
46	2011.06.08	18:42:24	72.91	1426.000	710.000	86.0	9.9	6.01	
47	2011.06.08	18:43:24	72.80	1420.000	710.000	86.0	9.9	5.99	
48	2011.06.08	18:44:24	73.26	1426.000	720.000	86.7	9.8	5.95	

Probe Info | Log data 1

Chapter 13 - TROUBLESHOOTING / ERROR MESSAGES

HI 9829 displays error messages to aid in troubleshooting. Warnings are displayed for most issues, while Errors are displayed for critical issues.

See the calibration chapter for messages that can occur during calibration. Other messages are listed below.

- “Log space full” appears when the meter memory is full and additional data cannot be logged or downloaded from a logging probe. Delete one or more lots from the meter (Log / Meter Log), or download and delete one or more logs from the probe.



- “Low probe external power supply level! Probe parameters disabled”: the battery voltage supplied from the meter to the probe is too low and the measurements could be adversely affected. All parameters set on probe are disabled. Press left soft key, check the connection between meter and probe. If the problem persists, contact the HANNA service center.

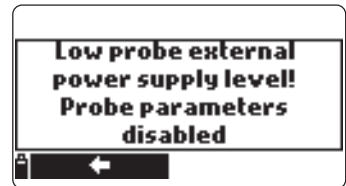

- “Power fault. Check the probe cable”: this message may appear when powering up the meter with a probe connected. If the meter detects a high load on the probe connection this message is triggered. Check the probe cable. If the problem persists, contact the HANNA service center.



- “Language data not available”: this message appears when powering up the meter if the language file is not seen by the meter. Restart the meter to verify this is a true meter error. If the problem persists, contact the HANNA service center.



- “GPS error” (only for models with GPS): the communication with the internal GPS unit cannot be established. Switch the meter off and on again, then retry. If the problem persists, remove the batteries, wait for 5 minutes and install them again. If the problem persists, contact the HANNA service center.



- “Dead meter battery!”: This message appears if the meter batteries are too low to power the meter and it will automatically turn off. Connect the charger if using rechargeable C batteries or replace the alkaline batteries to continue.



- “Insert rechargeable batteries and slide battery selector switch to the down position.”: This message appears when non-rechargeable alkaline batteries are installed on the meter and/ or the battery selector switch in is the wrong position, and the user is attempting to charge then batteries.

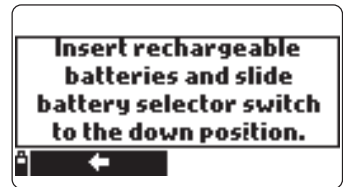

- “Dead probe battery!”: This message appears if the logging probes batteries are not supplying enough voltage to power the logging probe. Replace the probe batteries.



- “User data corrupted!”: This message appears when powering up the user data stored on meter are corrupted. Restart the meter. If the problem persists, contact the HANNA service center.



- “Warning x”: Any other warning that appears at power-on is identified using a numeric code. Restart the meter. If the problem persists, contact the HANNA service center. Some meter/probe features can be accessed but with no guarantee.



- “Errors x”: Any critical errors that appear are identified using a numeric code, and the meter is automatically switched off. Contact the HANNA service center.

APPENDIX A - PROBE MAINTENANCE

The HI 7698292 probe maintenance kit includes HI 7042S (electrolyte solution for D.O. sensor), spare membranes with o-rings for D.O. sensor, a small brush for cleaning EC, o-rings for sensor connectors and a syringe with grease to lubricate these o-rings.

General Maintenance

- Inspect all sensor connectors for corrosion and replace sensors if necessary.
- Inspect sensor o-rings for nicks or other damage and replace sensor if necessary. Lubricate only with grease from kit.



Use only the supplied grease as some lubricants can cause the o-rings to expand or affect the turbidity calibration standards.

- After prolonged storage or cleaning, calibration of the sensors is required.
- After use rinse the probe with tap water and dry it. The pH electrode bulb must be kept moist. Dry the D.O., EC and EC/Turbidity sensors. Dry ISE sensors and return to their storage caps if they will not be used for a period of time.
- Check GLP data under “Status” to ensure the sensor is still functioning properly.

pH and pH/ORP Sensor Maintenance

- Remove the sensor protective cap. Do not be alarmed if any salt deposits are present. This is normal with pH/ORP electrodes and they will disappear when rinsed with water.
- Shake down the sensor as you would do with a clinical thermometer to eliminate any air bubbles inside the glass bulb.
- If the bulb and/or junction are dry, soak the electrode in HI 70300 storage solution for at least one hour.
- To ensure a quick response time, the glass bulb and the junction should be kept moist and not allowed to dry. Store the sensor with a few drops of HI 70300 storage solution or pH 4.01 buffer in the protective cap. Tap water may also be used for a very short period (few days).



Never use distilled or deionized water to store pH sensors

- Inspect the sensor for scratches or cracks. If any are present, replace the sensor.
- Cleaning procedure: clean the sensor frequently by soaking it for 1 minute in HI 70670 or HI 70671 cleaning solution. After cleaning soak the sensor in HI 70300 storage solution before taking measurements.

D.O. Sensor Maintenance

For a top performance probe, it is recommended to replace the membrane every 2 months and the electrolyte monthly.

Proceed as follows:

- Unscrew the membrane by turning it counterclockwise.
- Rinse a spare membrane with some electrolyte while shaking it gently. Refill with clean electrolyte.
- Gently tap the cap over a surface to ensure that no air bubbles remain trapped. Avoid touching the membrane.
- With the sensor facing down, completely screw the cap clockwise. Some electrolyte will overflow.

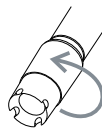

If any deposits scale the sensor, gently brush the sensor surface with the supplied brush, while paying attention to not damage the plastic body. Do not use the brush on the membrane.

EC Sensor Maintenance

- After every series of measurements, rinse the probe with tap water.
- If a more thorough cleaning is required, clean the sensor with the supplied brush or a non-abrasive detergent. Ensure that the two cylindrical holes in the sensor are free of foreign material.

EC/Turbidity Sensor Maintenance

- After every series of measurements, rinse the probe with tap water.
- If a more thorough cleaning of the sensor is required, clean the EC cylindrical holes in the sensor with the supplied brush or a non-abrasive detergent. Ensure that the two cylindrical holes are free of foreign material.
- Gently remove any material that is attached to the face of the turbidity sensor taking care to not scratch the optical windows. Use a soft cloth and non-abrasive detergent.
- If there are cracks or scratches on the optical windows, the EC/turbidity sensor must be replaced.

ISE Sensor Maintenance

- After measurements inspect o-ring, connector and body. Rinse ISE sensor with tap water to remove films or other coatings.
- Shake down the sensor as you would do with a clinical thermometer to eliminate any air bubbles.
- Soak the electrode in its corresponding 10 ppm calibration solution for at least 1/2 hour prior to calibration. Store dry in protective cap when not in use.

- For long-term storage rinse the electrodes with water. Shake off the excess water and replace the storage cap to prevent evaporation of the reference electrolyte.
- For chloride sensors (HI 7609829-11), if the sensor pellet appears tarnished, use a polishing strip to remove the oxidized surface. Cut off approximately a 1 inch piece of the strip. Wet the frosted side with water and place against damaged surface. Place your thumb against the shiny backing and slowly rotate back and forth while applying gentle pressure. If dark deposits appear on the frosted surface, move the paper slightly. Continue polishing until you are satisfied with the surface. Rinse sensor with water.

APPENDIX B - PROBE DEPLOYMENT

The Hanna HI 76X0929 has been designed for a variety of water quality measurements both in situ or in active deployments in urban or natural waters. The HI 9829 systems may be used for discrete spot sampling with a meter and the meter's log on demand function, unattended with continuous monitoring and logging from the meter, or unattended using a logging probe. These data are then downloaded to a meter or PC and can be plotted with logging software to obtain the graphical log needed for interpretation of the essential physical property of the aqueous body of water.

In all of these deployment situations data quality is dependent upon the site location, service intervals, amount of coatings, sedimentation and vegetation, and the actual installation. The probe may be installed in a horizontal bank (fixed installation) or a vertical suspension. The maximum depth rating of 20 m (65') for the probe should be adhered to. (Note: actual sensor specifications may be less). The location must be accessible for the duration of the measurement (consider seasonal flooding, freezing and other acts of nature) when selecting a site. Many conditions may affect the quality of measurements. Select an installation site that is representative of the water body being monitored. Avoid areas without adequate water circulation. To protect equipment it is best to avoid exposure to wind, foam, turbulence, air temperature gradients/sun, extended periods of high flow, extended periods of high sediment and floating debris. The standard operating procedures (SOP) for the data gathering must be upheld. This typically includes pre and post deployment checks of the sensors to validate data gathered between calibrations, upholding service intervals, and following any other site-specific procedures. Grab samples for laboratory analysis or spot sampling with another probe are addition ways to validate the measurements taken by unattended continuous logging probes.

The probe is suitable for installation in confined locations such as air vaults, river intakes, vertical wells, tanks, etc.. The streamline diameter of the probe permits insertion into 2" pipelines. Unlike probes that require a cable support for active deployments the probe can be manually lowered and raised by the cable due to it's superior strength member.

It is suitable for installation in open moving waters; rivers, streams, ditches (farmland drainage), conveyance canals, etc.. In these cases protecting the probe from debris is important. If the probe is suspended from a pier or bridge position it behind a support and anchor the cable/probe to a pipe.

It is suitable for deployment in open waters; monitoring lakes, ponds, wetland basin, infiltration basins, bays. Schedule regular service to remove aquatic weed growth that may be interfering with representative water samples.

The probe is suitable for measurements in a flow cell. Pumping water to a flow-through monitoring station has obvious pros and cons. Typically a shelter is required to secure a pump, and flow chamber. A power requirement, shelter, pump maintenance and higher installation cost need to be considered. Freeze protection, security, and convenience of calibration and possibility of adding multiple measurement points and antifouling preconditioning systems are advantages to this type of installation.

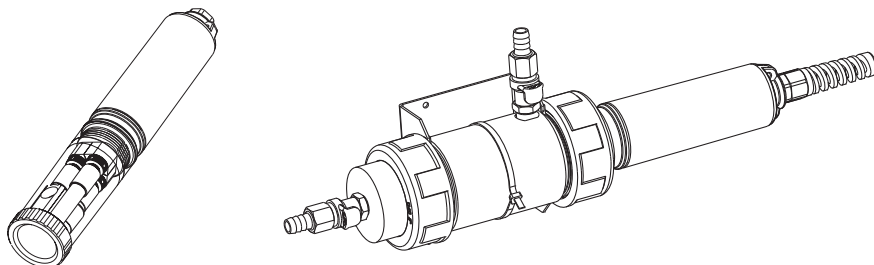

General Guidelines for fixed installation:

- Select a water-sampling site that will allow collection of representative water samples.
- Position the probe so the sensor surfaces face toward the flow. This will minimize air bubble or fluid cavitation. Limit flow rate to moderate
- Mount Probe 0 to 45° angle from vertical to avoid sensors (pH, pH/ORP, ISE) from becoming electrically discontinuous due to internal electrolytes flowing away from their internal cells.
- Install meter or probe where they will be accessible for maintenance as required.
- Regularly visit water sampling sites to: check for damage to sensors, the installation mountings, and the probe/meter battery power.
- Remove aquatic weed growth that may be interfering with water sample collection.
- Set up devices and programs for water monitoring and sampling.
- If the probe is suspended from a pier or bridge ensure that it is protected from debris by positioning behind a support and anchoring the cable /probe to a pipe.
- Have access to spare sensors and proper range standard solutions or buffers.
- Strictly follow the established SOP's.
- Download data to a laptop computer or meter on site.
- Flow cell installation; Avoid trapped air. Maintain constant flow rate.

APPENDIX C - ISE INFORMATION

This Appendix describes additional information about the ISE sensors used on the HI76x9829 Probe.

HI 7609829-10: Ammonium selective electrode (ISE) is a combination liquid membrane sensor used for the detection of free ammonium-nitrogen in fresh-water samples. The sensor utilizes a polymeric membrane made with ammonium ionophore in a PVC head and silver/silver chloride double junction gel filled reference electrode. The outer body of the sensor is the thermoplastic PEI. This sensor is used in place of the pH.

The measurement of ammonium-nitrogen, NH_4^+ -N is a useful tool in the measurement of surface water contaminants such as tracing the source of agricultural operations runoff or studying nutrient levels in natural waters.

HI 7609829-10 is an ion selective sensor that responds to the free Ammonium ion. Ammonium ion is the ionized portion of the total ammonia concentration and the amount present depends on pH. When the pH of the sample is below 8 pH, the primary form of ammonia is ammonium ion. See figure below.

The relationship is more complicated with increasing salinity but the two forms together equal total ammonia.

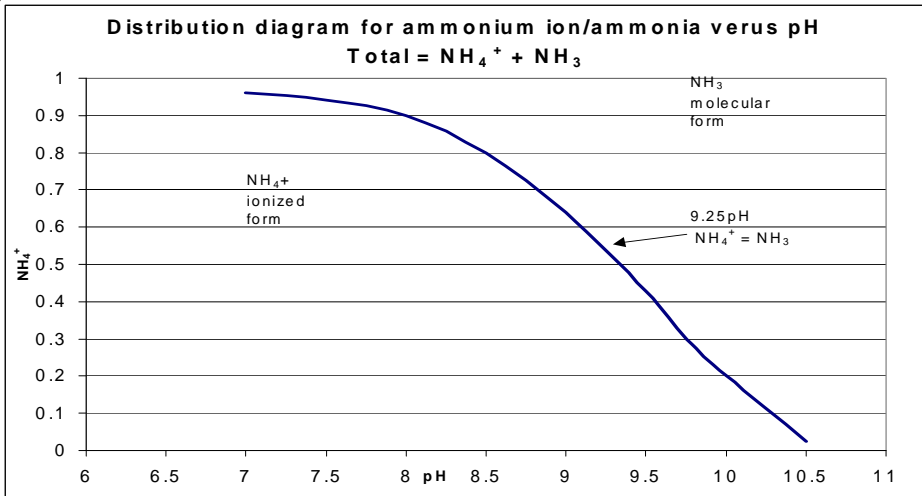

The HI 7609829-10 sensor is specified for 0.02 to 200 ppm (mg/L) NH_4^+ -N (equivalent to 0.026-260 ppm (mg/L) NH_4^+). Based on the corresponding molecular weights of nitrogen and ammonium, the relationship is: NH_4^+ -N = $(\text{NH}_4^+) \times 0.7778$. NH_4^+ -N is also called ionized ammonia. The sensor responds in a Nernstian manner (like a pH sensor) and produces a voltage that the meter converts to a concentration value.

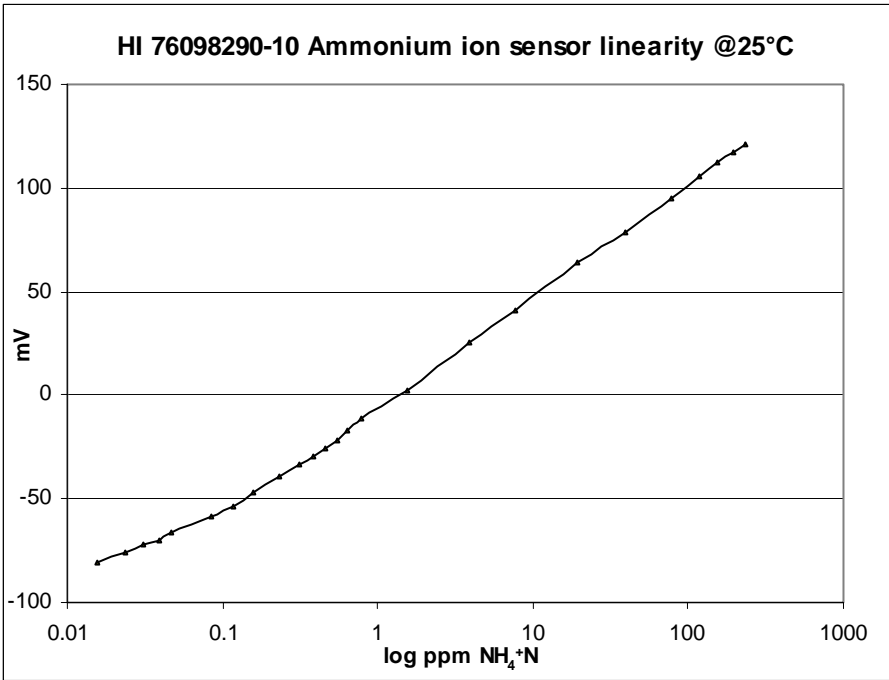

The calibration solutions and displayed measurements are as ppm Ammonium-nitrogen. Due to the space restriction of the display the unit of measurement will be displayed as “ppmAm”.

The ammonium sensor will last longer in colder clean waters than in severely contaminated water or warmer waters. This is because the active chemicals responsible for the ammonium ion sensitivity are leached out of the membrane with continued exposure. As the sensor ages there will be a decreased sensitivity until the sensor will no longer calibrate or operate properly. The lifetime of the sensor depends greatly on deployment conditions.

Although HI 7609829-10 is selective toward ammonium ions, it also responds to other ions which can interfere with the measurement. The ratio of interfering ion to ammonium ion must be less than the ratio indicated below:

- Sodium: 90
- Potassium: 0.75
- Calcium: 125
- Magnesium: 4000

Exposure to these interferences does not cause permanent damage to the sensor. Note that the potassium ion interference is the strongest, and its concentration must be less than the ammonium concentration to have no effect.

HI 7609829-11: Chloride ion selective electrode is a combination solid state sensor used for the detection of free chloride ions in freshwater samples. The sensor utilizes a silver chloride pellet housed in a PEI head and a silver/silver chloride double junction gel filled reference electrode. The outer body of the sensor is the thermoplastic PEI. This sensor is used in place of the pH sensor in the probe.

The measurement of chloride, Cl^- is a useful tool in the measurement of surface water contaminants such as tracing the source of roadway run off or studying naturally occurring chloride levels in natural waters. HI 7609829-11 is an ion selective sensor that responds to the free chloride ion. Chloride ion is the ionized form of chlorine.

HI 7609829-11 is specified for 0.6 to 200.0 ppm (mg/L) Cl^- . The sensor responds in a Nernstian manner (like a pH sensor) and produces a voltage that the meter converts to a concentration value.

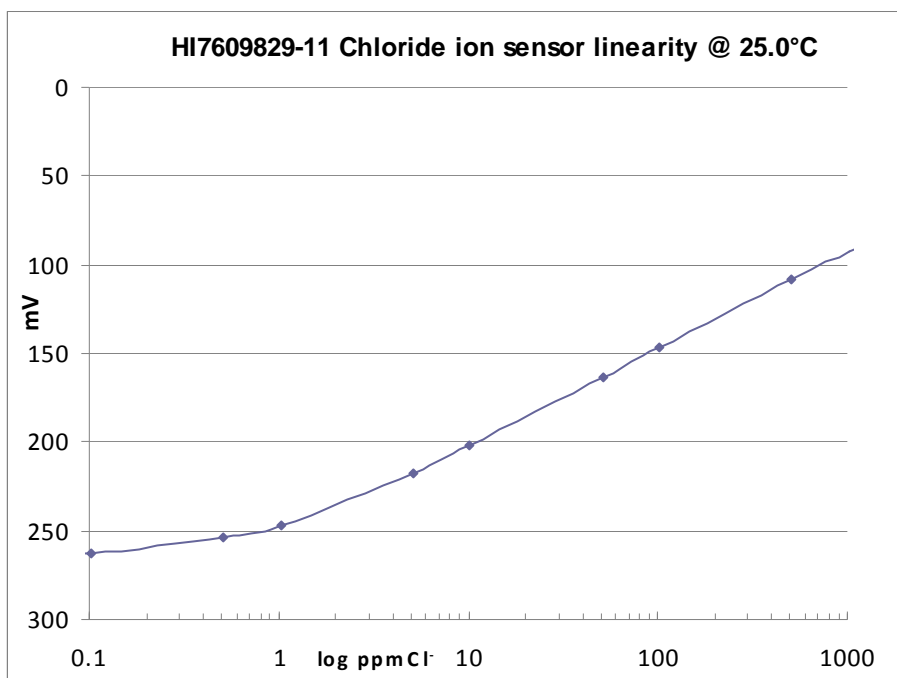

The calibration solutions and displayed measurements are as ppm Chloride ions. Due to the space restriction of the display the unit of measurement will be displayed as “ppmCl” (without charge).

The chloride sensor will last longer in colder clean waters than in severely contaminated water or warmer waters. This is because the external surface of the sensor responsible for the chloride ion sensitivity can react with water contaminants or be leached out of the sensor with continued exposure. As the sensor ages there will be a decreased sensitivity until the sensor will no longer calibrate or operate properly. The lifetime of the sensor depends greatly on deployment conditions.

Although HI 7609829-11 is selective toward chloride ions, it also responds to other ions.

The interfering ions sulfide, cyanide, and mercury ions must be absent.

The interfering ion to Cl⁻ ratio must be less than the ratio indicated below:

Iodine: 1.0

Bromide: 3.5

Carbonate: 3.5

Hydroxide: 1.0

Thiosulfate: 0.01

HI 7609829-12: Nitrate ion selective electrode is a combination liquid membrane sensor used for the detection of nitrate nitrogen in freshwater samples. The sensor utilizes a polymeric membrane made with nitrate ionophore in a PVC head and a silver/silver chloride double junction gel filled reference electrode. The outer body of the sensor is the thermoplastic PEI. This sensor is used in place of the pH sensor in the probe.

The measurement of Nitrate-Nitrogen, NO_3^- -N is a useful tool in the measurement of surface water contaminants such as tracing the source of agricultural operations runoff or studying nutrient levels in natural waters. HI 7609829-12 is an ion selective sensor that responds to the free nitrate ion.

Although all forms of nitrogen including nitrogen gas (N_2) are interconvertible within the nitrogen cycle as a function of oxidation state, the nitrate sensor only detects the ionized form.

HI 7609829-12 is specified for 0.62 to 200 ppm (mg/L) NO_3^- -N (equivalent to 2.74 - 885.6 ppm (mg/L) NO_3^-). Based on the corresponding molecular weights of nitrogen and nitrate, the relationship is: NO_3^- -N = $(\text{NO}_3^-)(14/62) = (\text{NO}_3^-) \times 0.2258$.

The sensor responds in a Nernstian manner (like a pH sensor) and produces a voltage that the meter converts to a concentration value.

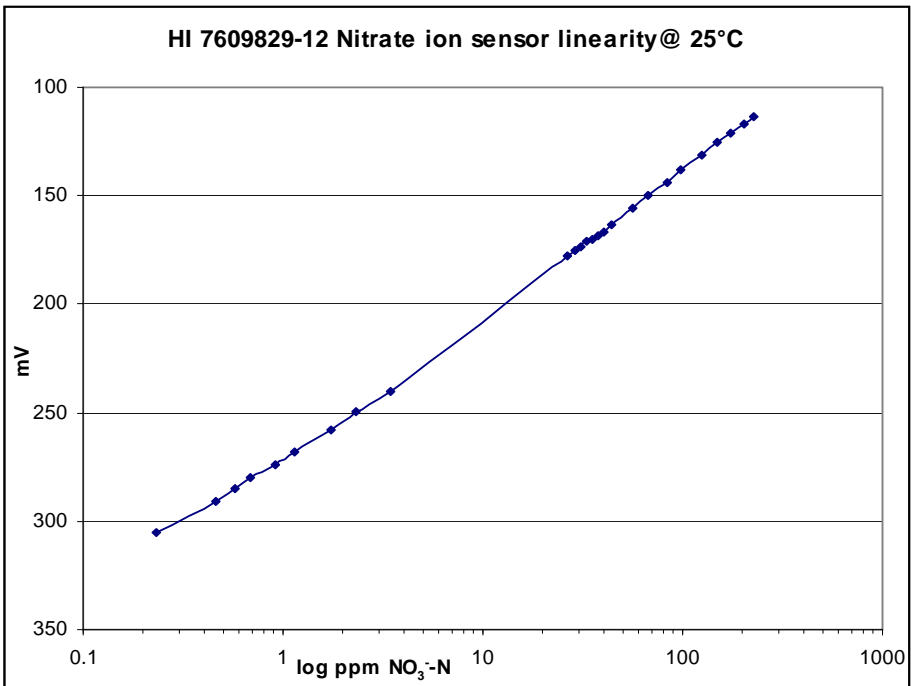

The calibration solutions and displayed measurements are as ppm Nitrate-nitrogen. Due to the space restriction of the display the unit of measurement will be displayed as “ppmNi”.

The nitrate sensor will last longer in colder clean waters than in severely contaminated water or warmer waters. This is because the active chemicals responsible for the nitrate ion sensitivity are leached out of the membrane with continued exposure. As the sensor ages there will be a decreased sensitivity until the sensor will no longer calibrate or operate properly. The lifetime of the sensor depends greatly on deployment conditions.

Although HI 7609829-12 is selective toward nitrate ions, it also responds to other ions which can interfere with the measurement. Organic solvents and cationic detergents must be absent. Chloride has the largest interference for natural waters.

The ratio of interfering ion to nitrate ion must be less than the ratio indicated below:

Fluoride: 300

Nitrite: 4

Chloride: 100

Iodide: 0.01

Carbonate: 4

Perchlorate: 0.0045

APPENDIX D - ACCESSORIES

METERS (packed in carton box, no probe)

HI 9829-01	Meter only, manual, charging cable adapter for 115VAC
HI 9829-02	Meter only, manual, charging cable adapter for 230VAC
HI 98290-01	HI 9829 with GPS, manual, charging cable adapter for 115VAC
HI 98290-02	HI 9829 with GPS, manual, charging cable adapter for 230VAC

PROBES (packed in carton box, without sensors)

HI 7609829/4	HI 7609829 probe for pH/pH+ORP/ISE, D.O., EC, temperature with HI 7698295 short protective shield and 4 meter (13.1') cable
HI 7609829/10	HI 7609829 probe for pH/pH+ORP/ISE, D.O., EC, temperature with HI 7698295 short protective shield and 10 meter (33') cable
HI 7619829/4	HI 7609829 probe for pH/pH+ORP/ISE, D.O., EC/EC+turbidity, temperature with HI 7698296 long protective shield and 4 meter (13.1') cable
HI 7619829/10	HI 7609829 probe for pH/pH+ORP/ISE, D.O., EC/EC+turbidity, temperature with HI 7698296 long protective shield and 10 meter (33') cable
HI 7629829/4	HI 7629829 logging probe for pH/pH+ORP/ISE, D.O., EC, temperature with HI 7698295 short protective shield and 4 meter (13.1') cable
HI 7629829/10	HI 7629829 logging probe for pH/pH+ORP/ISE, D.O., EC, temperature with HI 7698295 short protective shield and 10 meter (33') cable
HI 7639829/4	HI 7629829 logging probe for pH/pH+ORP/ISE, D.O., EC/EC+turbidity, temperature with HI 7698296 long protective shield and 4 meter (13.1') cable
HI 7639829/10	HI 7629829 logging probe for pH/pH+ORP/ISE, D.O., EC/EC+turbidity, temperature with HI 7698296 long protective shield and 10 meter (33') cable

Note: Probes with different cable length are available upon request.

METERS WITH PROBES (packed in carrying case with maintenance kit, charging adapter, sensors not included)

- HI 98291-01 HI 9829 and HI 7629829/4 logging probe for pH/pH+ORP/ISE, D.O., EC, temperature with HI 7698295 short protective shield and 4 meter (13.1') cable, probe maintenance kit, manual, charging cable adapter, for 115VAC
- HI 98291-02 Same as HI 98291-01, for 230VAC
- HI 98292-01 HI 9829 and HI 7639829/4 logging probe for pH/pH+ORP/ISE, D.O., EC/EC+turbidity, temperature with HI 7698296 long protective shield and 4 meter (13.1') cable, probe maintenance kit, manual, charging cable adapter, for 115VAC
- HI 98292-02 Same as HI 98292-01, for 230VAC
- HI 98293-01 HI 9829 and HI 7629829/10 logging probe for pH/pH+ORP/ISE, D.O., EC, temperature with HI 7698295 short protective shield and 10 meter (33') cable, probe maintenance kit, manual, charging cable adapter, for 115VAC
- HI 98293-02 Same as HI 98293-01, for 230VAC
- HI 98294-01 HI 9829 and HI 7639829/10 logging probe for pH/pH+ORP/ISE, D.O., EC/EC+turbidity, temperature with HI 7698296 long protective shield and 10 meter (33') cable, probe maintenance kit, manual, charging cable adapter, for 115VAC
- HI 98294-02 Same as HI 98294-01, for 230VAC
- HI 98295-01 HI 98290 with GPS and HI 7629829/4 logging probe for pH/pH+ORP/ISE, D.O., EC, temperature with HI 7698295 short protective shield and 4 meter (13.1') cable, probe maintenance kit, manual, charging cable adapter, for 115VAC
- HI 98295-02 Same as HI 98295-01, for 230VAC
- HI 98296-01 HI 98290 with GPS and HI 9829 and HI 7639829/4 logging probe for pH/pH+ORP/ISE, D.O., EC/EC+turbidity, temperature with HI 7698296 long protective shield and 4 meter (13.1') cable, probe maintenance kit, manual, charging cable adapter, for 115VAC
- HI 98296-02 Same as HI 98296-01, for 230VAC

- HI 98297-01 HI 98290 with GPS and HI 7629829/10 logging probe for pH/pH+ORP/ISE, D.O., EC, temperature with HI 7698295 short protective shield and 10 meter (33') cable, probe maintenance kit, manual, charging cable adapter, for 115VAC
- HI 98297-02 Same as HI 98297-01, for 230VAC
- HI 98298-01 HI98290 with GPS and HI 7639829/10 logging probe for pH/pH+ORP/ISE, D.O., EC/EC+turbidity, temperature with HI 7698296 long protective shield and 10 meter (33') cable, probe maintenance kit, manual, charging cable adapter, for 115VAC
- HI 98298-02 Same as HI 98298-01, for 230VAC

SENSORS

- HI 7609829-0 pH sensor
- HI 7609829-1 pH/ORP sensor
- HI 7609829-2 Dissolved Oxygen sensor
- HI 7609829-3 EC sensor
- HI 7609829-4 EC/Turbidity sensor
- HI 7609829-10 Ammonium ISE
- HI 7609829-11 Chloride ISE
- HI 7609829-12 Nitrate ISE

CABLES, CONNECTORS, ACCESSORIES

- HI 7698290 Short calibration beaker
- HI 7698293 Long calibration beaker
- HI 7698295 Short probe shield
- HI 7698296 Long probe shield
- HI 7698294 Short flow cell
- HI 7698297 Long quick release flow cell
- HI 7698292 Probe maintenance kit with HI 7042S (electrolyte for D.O. sensor), small brush, o-rings, syringe with grease to lubricate o-rings
- HI 920005 iButton® with holder (5 pcs)

HI 929829	PC application software
HI 7698291	USB cable PC to meter
HI 76982910	USB cable PC to probe
HI 710045	Powersupply cable
HI 710046	Cigarette lighter cable
HI 710005	115 VAC/12 VDC adapter, US plug
HI 710006	230 VAC/12 VDC adapter, European plug
HI 710012	230 VAC/12 VDC adapter, UK plug
HI 710013	230 VAC/12 VDC adapter, South African plug
HI 710014	230 VAC/12 VDC adapter, Australian plug
HI 710140	Hard carrying case for HI 9829

QUICK CALIBRATION SOLUTIONS

HI 9828-25	Quick calibration solution, 500 mL
HI 9828-27	Quick calibration solution, 1 gal.

pH BUFFERS

HI 5004	pH 4.01 buffer solution, 500 mL
HI 5046	pH 4.63 buffer solution, 500 mL
HI 5005	pH 5.00 buffer solution, 500 mL
HI 5006	pH 6.00 buffer solution, 500 mL
HI 5068	pH 6.86 buffer solution, 500 mL
HI 5007	pH 7.01 buffer solution, 500 mL
HI 5074	pH 7.41 buffer solution, 500 mL
HI 5008	pH 8.00 buffer solution, 500 mL
HI 5009	pH 9.00 buffer solution, 500 mL
HI 5091	pH 9.18 buffer solution, 500 mL
HI 5010	pH 10.01 buffer solution, 500 mL

ORP SOLUTIONS

HI 7020L	ORP test solution, 200/275 mV @ 20°C, 500 mL
HI 7021L	ORP test solution, 240 mV @ 20°C, 500 mL
HI 7022L	ORP test solution, 470 mV @ 20°C, 500 mL
HI 7091L	Reducing pretreatment solution, 500 mL
HI 7092L	Oxidizing pretreatment solution, 500 mL

pH/ORP MAINTENANCE SOLUTIONS (do not use for ISE)

HI 70670L	pH/ORP cleaning solution for salt deposits, 500 mL
HI 70671L	pH/ORP cleaning and disinfecting solution for algae, fungi and bacteria, 500 mL
HI 70300L	pH/ORP electrode storage solution, 500 mL

DO SOLUTIONS

HI 7040L	Zero oxygen solution, 500 mL
HI 7042S	Electrolyte solution for DO sensor, 30 mL
HI 76409A/P	Spare membrane with O-ring (5 pcs)

CONDUCTIVITY STANDARD SOLUTIONS

HI 7030L	12880 $\mu\text{S}/\text{cm}$ calibration solution, 500 mL
HI 7031L	1413 $\mu\text{S}/\text{cm}$ calibration solution, 500 mL
HI 7033L	84 $\mu\text{S}/\text{cm}$ calibration solution, 500 mL
HI 7034L	80000 $\mu\text{S}/\text{cm}$ calibration solution, 500 mL
HI 7035L	111800 $\mu\text{S}/\text{cm}$ calibration solution, 500 mL
HI 7039L	5000 $\mu\text{S}/\text{cm}$ calibration solution, 500 mL

TURBIDITY SOLUTIONS

HI 9829-16	0 FNU turbidity calibration solution, 100 mL
HI 9829-17	20 FNU turbidity calibration solution, 100 mL
HI 9829-18	200 FNU turbidity calibration solution, 100 mL

ISE SOLUTIONS

HI 9829-10	10 ppm ammonium (as N) standard for HI 7609829-10, 25 x 25 mL sachet
HI 9829-11	100 ppm ammonium (as N) standard for HI 7609829-10, 25 x 25 mL sachet
HI 9829-12	10 ppm chloride standard for HI 7609829-11, 25 x 25 mL sachet
HI 9829-13	100 ppm chloride standard for HI 7609829-11, 25 x 25 mL sachet
HI 9829-14	10 ppm nitrate (as N) standard for HI 7609829-12, 25 x 25 mL sachet
HI 9829-15	100 ppm nitrate (as N) standard for HI 7609829-12, 25 x 25 mL sachet

APPENDIX E - WARRANTY

All HANNA instruments® **meters are guaranteed for two years (sensors, electrodes and probes for six months)** against defects in workmanship and materials when used for their intended purpose and maintained according to instructions.

This warranty is limited to repair or replacement free of charge. Damage due to accident, misuse, tampering or lack of prescribed maintenance are not covered.

If service is required, contact the dealer from whom you purchased the instrument. If under warranty, report the model number, date of purchase, serial number and the nature of the failure.

If the repair is not covered by the warranty, you will be notified of the charges incurred.

If the instrument is to be returned to HANNA instruments®, first obtain a Returned Goods Authorization number from the Customer Service department and then send it with shipping costs prepaid.

When shipping any instrument, make sure it is properly packaged for complete protection.

Recommendations for Users

Before using this product, make sure that it is entirely suitable for the environment in which it is used. Operation of this instrument in residential areas could cause unacceptable interference to radio and TV equipment, requiring the operator to take all necessary steps to correct interferences. The glass bulb at the end of the electrode is sensitive to electrostatic discharges. Avoid touching this glass bulb at all time. To maintain the EMC performance of equipment, the recommended cables noted in the instruction manual must be used. Any variation introduced by the user to the supplied equipment may degrade the instruments' EMC performance. To avoid electrical shock, do not use these instruments when voltage at the measurement surface exceed 24 Vac or 60 Vdc. To avoid damage or burns, do not perform any measurement in microwave ovens.



Hanna Instruments Inc.
Highland Industrial Park
584 Park East Drive
Woonsocket, RI 02895 USA

Technical Support for Customers
Tel (800) 426 6287
Fax (401) 765 7575
E-mail tech@hannainst.com
www.hannainst.com

Local Sales and Customer Service Office

