

HI98192

USP Compliant
EC, TDS, NaCl, Resistivity,
Temperature Meter



INSTRUCTION MANUAL

 **HANNA**[®]
instruments

Dear Customer,

Thank you for choosing a Hanna Instruments product.

Please read this instruction manual carefully before using the instrument.

This manual will provide you with the necessary information for correct use of the instrument, as well as a precise idea of its versatility.

If you need additional technical information, do not hesitate to e-mail us at tech@hannainst.com or view our worldwide contact list at www.hannainst.com.

All rights are reserved. Reproduction in whole or in part is prohibited without the written consent of the copyright owner, Hanna Instruments Inc., Woonsocket, Rhode Island, 02895, USA.

PRELIMINARY EXAMINATION	4
GENERAL DESCRIPTION	5
FUNCTIONAL DESCRIPTION	6
SPECIFICATIONS	7
OPERATIONAL GUIDE	9
AUTORANGING	14
TEMPERATURE COMPENSATION	15
CONDUCTIVITY VERSUS TEMPERATURE CHART.....	16
USP MEASUREMENT	17
USP MODE PROCEDURES	21
USER CALIBRATION	25
EC CALIBRATION	26
GOOD LABORATORY PRACTICE (GLP)	33
SETUP	35
LOG ON DEMAND	47
AUTOLOG	50
AutoEnd	52
TEMPERATURE CALIBRATION (for technical personnel only)	53
PC INTERFACE	56
BATTERIES REPLACEMENT	63
TROUBLESHOOTING GUIDE	64
PROBE MAINTENANCE	65
ACCESSORIES	66

Remove the instrument from the packing material and examine it carefully to make sure that no damage has occurred during shipping. If there is any damage, notify your dealer or the nearest Hanna Customer Service Center.

Each instrument is supplied with:

- [HI763133](#) four-ring conductivity/TDS probe with temperature sensor (1.5 m cable)
- [HI7031M](#) 1413 $\mu\text{S}/\text{cm}$ calibration solution (230 ml)
- [HI7035M](#) 111.8 mS/cm calibration solution (230 ml)
- [HI920015](#) Micro USB cable
- [HI92000](#) PC Software
- 100 mL Plastic Beaker (2 pcs.)
- 1.5 V AA Batteries (4 pcs.)
- Instruction Manual and Quick Reference Guide
- Certificate

Note: Save all packing material until you are sure that the instrument functions correctly. All defective items must be returned in the original packing with the supplied accessories.

The HI98192 instrument is state-of-the-art, heavy-duty conductivity meter, designed to provide laboratory results and accuracy under harsh industrial conditions.

The USP standard compliance makes the instrument useful for pure water determination.

It is provided with a series of new diagnostic features which add an entirely new dimension to the measurement of conductivity, by allowing the user to dramatically improve the reliability of the measurement:

- 7 memorized standards (0.00 $\mu\text{S}/\text{cm}$, 84.0 $\mu\text{S}/\text{cm}$, 1.413 mS/cm, 5.00 mS/cm, 12.88 mS/cm, 80.0 mS/cm and 111.8 mS/cm) for calibration.
- EC calibration up to five calibration points.
- Messages on the graphic LCD for an easy and accurate calibration.
- Diagnostic features to alert the user when the electrode needs cleaning.
- User-selectable **"Outside Calibration Range"** warning.
- User-selectable "calibration time out" to remind when a new calibration is necessary.

Moreover, they offer an extended temperature range from -20.0 to 120.0 °C (-4.0 to 248.0 °F), using temperature sensor inside EC electrode.

This instrument can also measure in Resistivity, TDS and Salinity ranges. Three salinity modes are available: % NaCl, Practical salinity and Natural seawater scale.

Other features include:

- Temperature source selection
- Temperature automatic compensation, linear or non linear user selectable
- Temperature reference selection 15 °C, 20 °C or 25 °C.
- Temperature coefficient set
- Log on demand up to 400 samples
- Auto Log feature up to 1000 records
- Auto Hold feature, to freeze first stable reading on the LCD
- Lock and user setup Fixed range selection
- GLP feature, to view last calibration data for EC, NaCl
- Probe change recognition
- PC interface
- Probe replatinization

FRONT VIEW

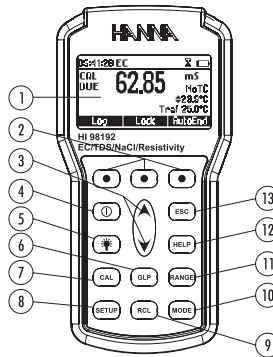

- 1) Liquid Crystal Display (LCD).
- 2) F1, F2, F3 functional keys.
- 3) ▲/▼ keys to manually increase/decrease the parameters or to scroll between the parameter list.
- 4) ON/OFF (⏻) key, to turn the instrument ON and OFF.
- 5) LIGHT (☀️) key to toggle display backlighting.
- 6) GLP key, to display Good Laboratory Practice information.
- 7) CAL key, to enter/exit calibration mode.
- 8) SETUP key, to enter/exit SETUP mode.
- 9) RCL key, to enter/exit view logged data mode.
- 10) MODE key to toggle between EC, USP and Salinity ranges.
- 11) RANGE key, to switch between EC, Resistivity, TDS, NaCl.
- 12) HELP key to enter/exit contextual help.
- 13) ESC to leave current mode, exit calibration, setup, help. etc.

TOP VIEW

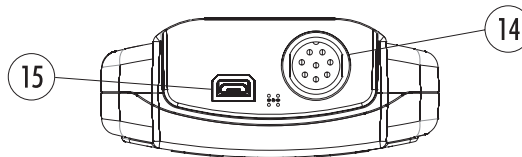

- 14) Electrode **DIN** connector.
- 15) USB connector.

EC	Range	0 to 400 mS/cm (shows values up to 1000 mS/cm) Actual conductivity 1000 mS/cm 0.001 to 9.999 μ S/cm* 10.00 to 99.99 μ S/cm 100.0 to 999.9 μ S/cm 1.000 to 9.999 mS/cm 10.00 to 99.99 mS/cm 100.0 to 1000.0 mS/cm (autoranging)
	Resolution	0.001 μ S/cm* / 0.01 μ S/cm / 0.1 μ S/cm 0.001 mS/cm / 0.01 mS/cm / 0.1 mS/cm
	Accuracy	$\pm 1\%$ of reading (± 0.01 μ S/cm or 1 digit whichever greater)
Resistivity	Range	1.0 to 99.9 Ω ·cm 100 to 999 Ω ·cm 1.00 to 9.99 K Ω ·cm 10.0 to 99.9 K Ω ·cm 100 to 999 K Ω ·cm 1.00 to 9.99 M Ω ·cm 10.0 to 100.0 M Ω ·cm* (autoranging)
	Resolution	0.1 Ω ·cm / 1 Ω ·cm / 0.01 K Ω ·cm / 0.1 K Ω ·cm / 1 K Ω ·cm 0.01 M Ω ·cm / 0.1 M Ω ·cm*
	Accuracy	$\pm 1\%$ of reading (± 10 Ω ·cm or 1 digit whichever greater)
TDS	Range	0.00 to 99.99 ppm 100.0 to 999.9 ppm 1.000 to 9.999 g/L 10.00 to 99.99 g/L 100.0 to 400.0 g/L (autoranging)
	Resolution	0.01 ppm / 0.1 ppm / 0.001 g/L / 0.01 g/L / 0.1 g/L
	Accuracy	$\pm 1\%$ of reading (± 0.05 ppm or 1 digit whichever greater)

* The 0.001 μ S/cm EC range and 0.1 M Ω ·cm Resistivity range are not available with the 1.5 m cable probe.

Salinity	Range	% NaCl: 0.0 to 400.0 % Seawater scale: 0.00 to 80.00 (ppt) Practical salinity: 0.01 to 42.00 (PSU)
	Resolution	0.1 % / 0.01 ppt / 0.01 PSU
	Accuracy	±1% of reading
Temperature	Range	-20.0 to 120.0 °C (-4.0 to 248.0 °F)
	Resolution	0.1 °C (0.1 °F)
	Accuracy	±0.2 °C (±0.4 °F) (excluding probe error)
EC Calibration	Automatic up to five points with seven memorized standards (0.00 µS/cm, 84.0 µS/cm, 1.413 mS/cm, 5.00 mS/cm, 12.88 mS/cm, 80.0 mS/cm, 111.8 mS/cm)	
Cell Constant Setup	0.010 to 10.000	
NaCl Calibration	Max. one point only in % range (with HI7037 standard); use conductivity calibration for other ranges	
Implemented Standards	USP compliant	
EC Probe	HI763133 (8 pin DIN, 1.5 m cable)	
Temperature Source	Automatic from sensor inside the probe; Manual entry	
Temperature Compensation	NoTC, Linear, Non Linear ISO/DIS 7888 std	
Reference Temperature	15, 20, 25 °C	
Temperature Coefficient	0.00 to 10.00 %/°C	
TDS Factor	0.40 to 1.00	
Log on Demand	400 samples	
Lot Logging	5, 10, 30 sec, 1, 2, 5, 10, 15, 30, 60, 120, 180 min (max 1000 samples)	
Memorized Profiles	Up to 10	
Measurement Modes	Autorange, AutoEnd, LOCK and Fixed range	
Battery Type / Life	1.5V AA batteries (4 pcs.) / 100h no backlight 25h with backlight	
Auto Power Off	User selectable: 5, 10, 30, 60 minutes or disabled	
PC Connectivity	Opto-isolated USB	
Dimensions	185 x 93 x 35.2 mm (7.3 x 3.6 x 1.4")	
Weight	400 g (14.2 oz)	
Environment	0 to 50 °C (32 to 122 °F) max. RH 100% IP67	

INITIAL PREPARATION

The instrument is supplied complete with batteries. See Batteries Replacement for details, page 63.

To prepare the instrument for field measurements close the serial communication socket with proper stopper (to ensure waterproof protection).

Connect the EC probe to the DIN connector on the top of the instrument. Tighten the thread ring. Make sure the probe sleeve is properly inserted.

Turn the instrument ON by pressing **ON/OFF** key.

At start-up the display will show the Hanna logo for a few seconds followed by the percentage indication of the remaining battery life and the "**Loading Log...**" message, then enters the measurement mode.



The Auto Power Off feature turns the instrument off after a set period (default 30 min) with no button pressed to save battery life. To set another period or to disable this feature, see **SETUP** menu on page 35. The instrument continues to monitor the inputs and memorize readings if the automatic logging is enabled and started. To stop autologging press **StopLog** key or simply power off the instrument by pressing the **ON/OFF** key.

The Auto Light Off backlight feature turns the backlight off after a set period (default 1 min) with no buttons pressed. To set another period or to disable this feature, see **SETUP** menu on page 35.

MEASUREMENTS

Immerse the probe into the solution to be tested. The sleeve holes must be completely submerged. Tap the probe repeatedly to remove any air bubbles that may be trapped inside the sleeve.

If needed, press **RANGE** repeatedly until the desired range (EC, Resistivity, TDS, Salinity) is selected on the LCD.

Allow for the reading to stabilize. The main LCD line displays the measurement in the selected range, while the temperature is displayed on the lower LCD line.

EC range

The conductivity range is from 0 to 400 mS/cm. The actual conductivity range (the uncompensated conductivity) is up to 1000 mS/cm. The instrument will display conductivity readings up to 1000 mS/cm.

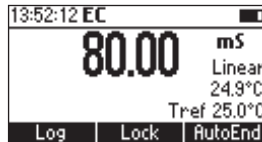

Note: The \blacklozenge symbol in front of the temperature reading means that the temperature can be entered by the user (Manual option selected in SETUP, or temperature out of range).

Resistivity range

The reciprocal of the conductivity of a material is the resistivity.



TDS range

A conductivity measured value can be corrected to a total dissolved solids value using the TDS factor.

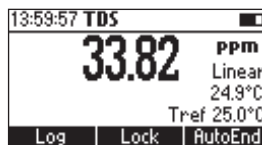

Salinity

The salinity is derived from the conductivity of a sample.

Salt % range

The percent of salinity in a sample is dependent on the sample and the salinity coefficient.

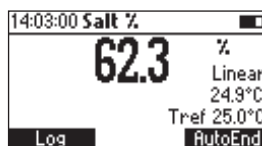

For practical reasons, the salinity of a solution is derived from the salinity of the seawater. Two methods of calculating the salinity from the conductivity are supported:

- Natural seawater scale
- Practical salinity scale

Natural seawater scale (UNESCO 1966)

According to the definition, salinity of a sample in ppt is calculated using the following formula:

$$R_T = \frac{C_T(\text{sample})}{C(35;15) \cdot r_T}$$

$$r_T = 1.0031 \cdot 10^{-9} T^4 - 6.9698 \cdot 10^{-7} T^3 + 1.104259 \cdot 10^{-4} T^2 + 2.00564 \cdot 10^{-2} T + 6.766097 \cdot 10^{-1}$$

$$R = R_T + 10^{-5} R_T (R_T - 1.0) (T - 15.0) [96.7 - 72.0 R_T + 37.3 R_T^2 - (0.63 + 0.21 R_T^2) (T - 15.0)]$$

$$S = -0.08996 + 28.2929729R + 12.80832R^2 - 10.67869R^3 + 5.98624R^4 - 1.32311R^5$$

where:

R_T - coefficient;

$C_T(\text{sample})$ - uncompensated conductivity at T °C;

$C(35;15) = 42.914$ mS/cm - the corresponding conductivity of KCl solution containing a mass of 32.4356 g KCl / 1 Kg solution;

r_T - temperature compensation polynomial.

Note: The formula can be applied for temperatures between 10 °C and 31 °C.

To access this range press Mode while in Salinity range until the seawater scale [SW] is displayed.

Practical salinity scale



This is a practical scale based on the precise measurement of the electrical conductivity of a solution with a known salinity range.

The relationship derived from the scale relates salinity, conductivity, temperature and pressure and use a solution with a salinity of 35 ‰ as datum point. This is taken to have a conductivity of 42.914 mS/cm of 15 °C at standard atmospheric pressure.

According to the definition, salinity of a sample in PSU (practical salinity units) is calculated using the following formula:

$$R_T = \frac{C_T(\text{sample})}{C(35; 15) \cdot r_T}$$

$$r_T = 1.0031 \cdot 10^{-9} T^4 - 6.9698 \cdot 10^{-7} T^3 + 1.104259 \cdot 10^{-4} T^2 + 2.00564 \cdot 10^{-2} T + 6.766097 \cdot 10^{-1}$$

$$\text{Sal} = \sum_{k=0}^5 a_k \cdot R_T^{\frac{k}{2}} + f(t) \cdot \sum_{k=0}^5 b_k R_T^{\frac{k}{2}} - \frac{c_0}{1 + 1.5X + X^2} - \frac{c_1 f(t)}{1 + Y^2 + Y^{\frac{3}{2}}}$$

$$f(t) = \frac{T - 15}{1 + 0.0162 \cdot (T - 15)}$$

R_T - coefficient;

$C_T(\text{sample})$ - uncompensated conductivity at T °C;

$C(35; 15) = 42.914$ mS/cm - the corresponding conductivity of KCl solution containing a mass of 32.4356 g KCl/1 Kg solution;

r_T - temperature compensation polynomial

$$a_0 = 0.008 \quad b_0 = 0.0005$$

$$a_1 = -0.1692 \quad b_1 = -0.0056$$

$$a_2 = 25.3851 \quad b_2 = -0.0066$$

$$a_3 = 14.0941 \quad b_3 = -0.0375$$

$$a_4 = -7.0261 \quad b_4 = 0.0636$$

$$a_5 = 2.7081 \quad b_5 = -0.0144$$

$$c_0 = 0.008$$

$$c_1 = 0.0005$$

$$X = 400R_T$$

$$Y = 100R_T$$

$$f(T) = (T - 15) / [1 + 0.0162(T - 15)]$$

*Notes: The formula can be applied for salinity values between 0 and 42 PSU.
The formula can be applied for temperatures between -2 °C and 35 °C.*

To reach this range press **Mode** while in Salinity range until the practical salinity scale [PSU] is displayed.



Notes: If the meter displays the top of the range blinking, the reading is out of range.

If the stability indicator "Σ" blinks, the reading is unstable.

Make sure the meter is calibrated before taking measurements.

If measurements are taken successively in different samples, for accurate readings it is recommended to rinse the probe thoroughly with deionized water before immersing it into the samples.

TDS reading is obtained by multiplying the EC reading by the TDS factor, which has a default value of 0.50. It is possible to change the TDS factor in the 0.40 to 1.00 range by entering SETUP mode.

The probes designed to work with this instrument have an internal ID identification. Every time the instrument detects probe changing, it reminds the user to update the cell constant of the new probe being used and to calibrate in the appropriate EC range.

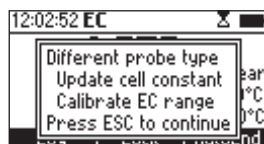

The EC, Resistivity and TDS scales are autoranging. The meter automatically sets the scale with the highest possible resolution.

By pressing **Lock**, the autoranging feature is disabled and the current range is frozen on the LCD.

The "**Range: Locked**" message is displayed. To restore the autoranging option press "AutoRng" functional key again.

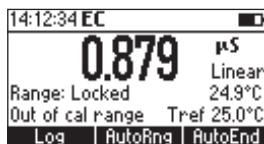

The autoranging mode is also disabled by selecting a **fixed range** in the SETUP menu. While in fixed range mode the instrument will display the readings with the fixed resolution. A maximum of 6 digits can be displayed. The top of the **fixed range** is displayed blinking when the reading exceeds this value. To disable **fixed range** mode enter SETUP and select autoranging mode.

Note: Autoranging is automatically restored if the range is changed, if the calibration mode is entered, or if the meter is turned off and back on again.



Two selectable temperature sources are available: reading directly from the sensor inside the probe or manual entry.

Three options of compensating temperature are available:

Linear Temperature Compensation: The conductivity of a solution with a specific electrolyte concentration changes with temperature. The relationship of the change in conductivity as a function of temperature is described by a solution's temperature coefficient. This coefficient varies with each solution and is user selectable (see SETUP mode).

Non Linear Temperature Compensation: for natural water measurements.

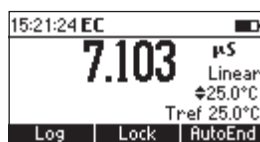

The conductivity of natural water shows strong non linear temperature behavior.

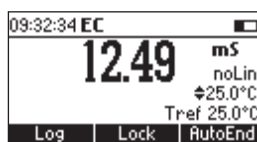

A polynomial relationship is used to improve the accuracy of the calculated results.

Note: Conductivity measurements of natural water can only be performed at temperatures ranging from 0 to 36 °C. Otherwise the "Out T range" message will be displayed blinking.

No Temperature Compensation (No TC): The temperature shown on the LCD is not taken into account.

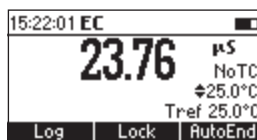

To select the desired option enter Setup menu (see page 35).

If the temperature is out of the -20 °C - 120 °C range the instrument will do no temperature compensation.

The conductivity of an aqueous solution is the measure of its ability to carry an electrical current by means of ionic motion.

The conductivity invariably increases as the temperature rises.

It is affected by the type and number of ions in the solution and by the viscosity of the solution itself. Both parameters are temperature dependent. The dependency of conductivity on temperature is expressed as a relative change per Celsius degree at a particular temperature, commonly as percent per °C (%/°C).

The following table lists the temperature dependence of the HANNA calibration buffers.

°C	°F	HI7030 HI8030 ($\mu\text{S}/\text{cm}$)	HI7031 HI8031 ($\mu\text{S}/\text{cm}$)	HI7033 HI8033 ($\mu\text{S}/\text{cm}$)	HI7034 HI8034 ($\mu\text{S}/\text{cm}$)	HI7035 HI8035 ($\mu\text{S}/\text{cm}$)	HI7039 HI8039 ($\mu\text{S}/\text{cm}$)
0	32.0	7150	776	64	48300	65400	2760
5	41.0	8220	896	65	53500	74100	3180
10	50.0	9330	1020	67	59600	83200	3615
15	59.0	10480	1147	68	65400	92500	4063
16	60.8	10720	1173	70	67200	94400	4155
17	62.6	10950	1199	71	68500	96300	4245
18	64.4	11190	1225	73	69800	98200	4337
19	66.2	11430	1251	74	71300	100200	4429
20	68.0	11670	1278	76	72400	102100	4523
21	69.8	11910	1305	78	74000	104000	4617
22	71.6	12150	1332	79	75200	105900	4711
23	73.4	12390	1359	81	76500	107900	4805
24	75.2	12640	1386	82	78300	109800	4902
25	77.0	12880	1413	84	80000	111800	5000
26	78.8	13130	1440	86	81300	113800	5096
27	80.6	13370	1467	87	83000	115700	5190
28	82.4	13620	1494	89	84900	117700	5286
29	84.2	13870	1521	90	86300	119700	5383
30	86.0	14120	1548	92	88200	121800	5479
31	87.8	14370	1575	94	90000	123900	5575

Pharmaceutical laboratories working in the US market are obliged to respect the regulations set down by the US Pharmacopoeia (USP). The 5th supplement of [USP24-NF19](#) lays down the rules for checking the quality of pure or fully deionized water used for the production of injection products.

The conductivity of water provides information on its chemical composition. It is therefore logical that conductivity is the main parameter to measure.

The conductivity of water is a measure of the ion mobility through this water. The conductivity partly depends on the pH, the temperature and the amount of atmospheric carbon dioxide, which has been dissolved in water to form ions (intrinsic conductivity). The conductivity also depends on the chloride, sodium and ammonium ions initially present in water (extraneous conductivity).

The conductivity (intrinsic and extraneous) of the water is measured at Stage 1 and compared to values listed in a table to evaluate if the studied water is suitable or not for use in pharmaceutical applications. If the sample fails Stage 1, additional tests have to be performed (Stage 2 and 3) in order to determine if the excessive conductivity value is due to intrinsic factors or extraneous ions.

USP Requirements

Automatic temperature correction must not be used.

Instrument specifications

Minimum resolution of 0.1 $\mu\text{S}/\text{cm}$ on the lowest range. Excluding the cell accuracy, the instrument accuracy must be $\pm 0.1 \mu\text{S}/\text{cm}$.

Meter calibration

It is accomplished by replacing the conductivity cell with precision resolution traceable to primary standards (accurate to $\pm 0.1\%$ of the stated value) or an equivalently accurate resistance device.

Cell calibration

Meter conductivity must be measured accurately using calibrated instrumentation. The conductivity cell constant must be known in $\pm 2\%$.

Before starting water analysis calibrate in the lowest EC range or set the probe cell constant (enter the value written in the calibration certificate delivered with the probe).

Stage 1

Determine the temperature and conductivity of the water.

- Rinse the probe carefully with deionized water. Check that the 4 rings, sleeve holes and the temperature sensor are immersed in the sample and that no air bubbles are trapped. Connect the probe to the meter, enter USP mode and press the **Stage 1** key. The instrument will perform a temperature and conductivity measurement (using a non-temperature corrected conductivity reading).

- Using the Stage 1 temperature and conductivity requirement table the corresponding conductivity limit at that temperature is determined.
- If the measured conductivity is not greater than the table value the water meets the requirements of the test for conductivity. If the conductivity is higher than the table value, proceed with Stage 2.

Stage 1 table

Temperature and conductivity requirements *

(for the non-temperature compensated conductivity measurements only)

(*) Values from USP - NF Fifth Supplement

Temperature °C	Conductivity μS/cm
0	0.6
5	0.8
10	0.9
15	1.0
20	1.1
25	1.3
30	1.4
35	1.5
40	1.7
45	1.8
50	1.9
55	2.1
60	2.2
65	2.4
70	2.5
75	2.7
80	2.7
85	2.7
90	2.7
95	2.9
100	3.1

Physical Tests / Water Conductivity (645) 3465-3467

Stage 2

Determine the influence of CO₂.

Note: Stability criteria <0.5 %/min corresponds in fact to a change in conductivity <0.02 μS/cm per minute (equivalent to 0.1 mS/cm per 5 minutes), as required in the Stage 2 USP document.

- Transfer a sufficient amount of water (100 mL or more) to a thermostatic vessel, and stir the test specimen. Adjust the temperature and maintain it at 25 ± 1 °C. We recommend using a thermostatic bath.
- Rinse the cell carefully with deionized water. Place the conductivity probe in the sample and dip it in the thermostatic vessel containing the sample. Check that the 4 rings and sleeve holes are immersed in the solution.
- Press **Stage 2**.
- When the conductivity value is stable, if the conductivity is not greater than 2.1 μS/cm the water meets the requirements of the test, for conductivity.

If the conductivity is greater than 2.1 μS/cm proceed with Stage 3.

Stage 3

Determine the combined effect of the CO₂ and pH.

Use a Hanna Instruments pH meter.

Take care that the instrument is calibrated in at least two points using pH 4.01 and pH 7.01 Hanna buffers.

Perform the following test within approximately 5 minutes of the conductivity determination while maintaining the sample temperature at 25 ± 1 °C.

- Add the Saturated KCl Solution to the sample (0.3 mL per 100 mL of the test specimen), and determine the pH to the nearest 0.1 pH unit.
- Press **Stage 3** key, then enter the corresponding pH reading.
- Referring to the Stage 3 pH and conductivity requirement table the instrument determines the conductivity limit at the measured pH value. If the measured conductivity is no greater than the conductivity requirements for the pH determined the water meets the requirements of the test for conductivity. If the measured conductivity is greater than this value or the pH is outside of the range of 5.0 to 7.0, the water does not meet the requirements of the test for conductivity.

Stage 3

pH and conductivity requirements

(For atmosphere and temperature equilibrated samples only)

pH	Conductivity $\mu\text{S}/\text{cm}$
5.0	4.7
5.1	4.1
5.2	3.6
5.3	3.3
5.4	3.0
5.5	2.8
5.6	2.6
5.7	2.5
5.8	2.4
5.9	2.4
6.0	2.4
6.1	2.4
6.2	2.5
6.3	2.4
6.4	2.3
6.5	2.2
6.6	2.1
6.7	2.6
6.8	3.1
6.9	3.8
7.0	4.6

Press **Mode** key while in EC range to enter USP mode.
The instrument will display USP on the main screen.

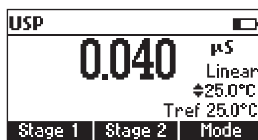

Press **Stage 1** to start with first stage evaluation.
Press **Stage 2** to start with second stage evaluation.
If **Stage 1** is pressed, a tutorial screen is displayed.

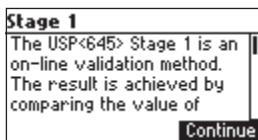

Use the ▲/▼ keys to scroll the tutorial message.
Press **Continue** to skip the tutorial message and enter EC measuring mode.

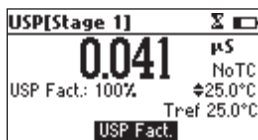

If the temperature source is manual entry, press **USP Fact.** to select USP factor to be changed (the ♦ is displayed before the 100% value). To increase the accuracy of the analysis decrease the USP factor value.

Wait until reading is stable.

If the sample reading meets the USP Stage 1 criteria, the "USP Met" message will be displayed.

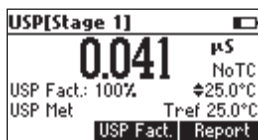

Press **Report** to view report.

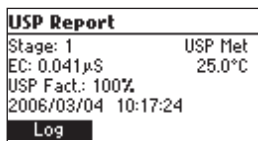

Press **Log** to store USP Stage 1 report.

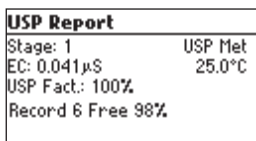

The report number and the amount of free log space in % is displayed for several seconds.

Note: If the log space is full enter view logged data mode by pressing RCL key and free log space by deleting previously stored records.

If the sample reading didn't meet the USP Stage 1 criteria, the "USP Not Met" message is displayed.

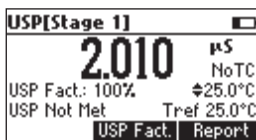

Press **ESC** to return to the USP main screen.

Press **Report** to view USP report.

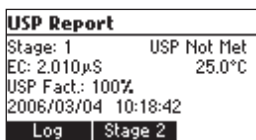

Press **Log** to store the Stage 1 report.

Press **Stage 2** to enter USP Stage 2 mode.

The **USP Stage 2** tutorial screen is displayed.

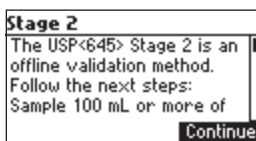

Use the **▲/▼** keys to scroll the tutorial message.

Press **Continue** to skip the tutorial message and enter **USP Stage 2** measuring mode.

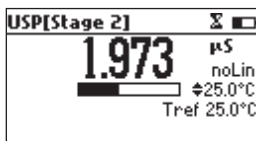

Wait until the reading is stable (about 5 minutes).

Note: If the input record has an instability higher than 1 mS, stability period will be reset. The completion time bar will remain empty.

The "USP Met" message will be displayed if the USP Stage 2 criteria is reached.



Press **Report** to view the USP report.

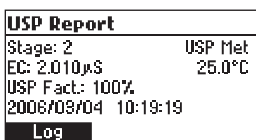

Press **Log** to store report.

Notes: The report number will be the same as at the Stage 1 report (informations of the same analysis).

If the log space is full enter view logged data mode by pressing RCL key and free log space by deleting previously stored records.

The "USP Not Met" message is displayed if the USP Stage 2 criteria is not met.

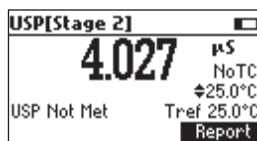

Press **Report** to view report.

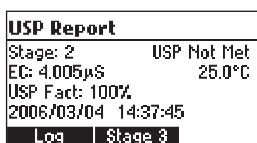

Press **Stage 3** to enter in Stage 3 water analysis.
 The **USP Stage 3** tutorial is displayed.

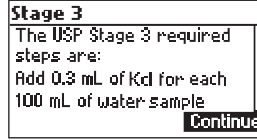

Press **Continue** to enter **USP Stage 3** analysis.
 The instrument will display the sample pH setting mode.

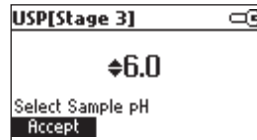

Use a calibrated pH meter to read the pH value of the sample.
 Use **▲/▼** keys to set the value to that displayed on the pH meter.
 Press **Accept** to confirm the pH setting.
 The **USP Stage 3** report will be displayed.

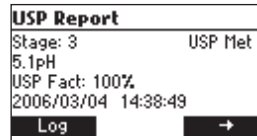

The report will include all stages information.
 Press **→** key to scroll the report pages .
 Press **Log** to store the report.
 Press **ESC** to return to USP main screen.

*Notes: The Stage 3 report will include the information about Stage 1 and Stage 2.
 If the log space is full enter view logged data mode by pressing RCL key and free log space by deleting previously stored records.*

To enter **User Calibration** screen press **CAL** key while in EC or Salinity range.

From EC range



Press the corresponding functional key to enter:

- EC user calibration.
- Probe replatinization.
- Temperature user calibration.

From Salinity % range

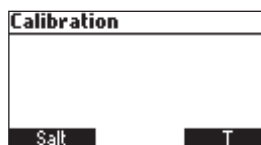

Press the corresponding functional key to enter:

- Salinity % user calibration.
- Temperature user calibration.

It is recommended to calibrate the instrument frequently, especially if high accuracy is required.

The EC range should be recalibrated:

- Whenever the EC electrode is replaced.
- At least once a week.
- Before USP measurement.
- After testing aggressive chemicals.
- When calibration alarm time out is expired - “**CAL DUE**” blinks (if feature is enabled in SETUP).
- If “**Outside Cal Range**” message blinks during EC measurement (the measurement range is not covered by current calibration, if feature is enabled in SETUP).

Note: TDS and Resistivity readings are automatically derived from the EC reading and no specific calibration is needed.

PROCEDURE

HI98192 instrument offers a choice of 7 memorized standards (0.00 $\mu\text{S}/\text{cm}$, 84.0 $\mu\text{S}/\text{cm}$, 1.413 mS/cm , 5.00 mS/cm , 12.88 mS/cm , 80.0 mS/cm and 111.8 mS/cm).

For accurate EC measurements, it is recommended to perform a calibration in maximum allowed points. However, at least a two point calibration is suggested (offset calibration in 0.00 μS and one in any other calibration standard).

The instrument will automatically recognize the standards and skip the standard used during calibration.

- If a five point calibration is performed, one of the points must be 0.0 μS (offset).
- Pour small quantities of selected standard solutions into clean beakers. For accurate calibration use two beakers for each standard solution, the first one for rinsing the electrode and the second one for calibration.
- Remove the protective cap and rinse the electrode with some of the standard solution to be used for the first calibration point.

FIVE POINT CALIBRATION

- It is recommended to perform the first point calibration as offset calibration.
- Tap the probe repeatedly to remove any air bubbles that may be trapped inside the sleeve.
- For offset (zero) calibration, just leave the dry probe in the air.
- From EC range press **CAL** to enter calibration screen.
- Leave the probe in the air and press **EC**. The instrument will display the measured EC on the LCD, first expected standard and the temperature reading.



- If necessary, press the keys ▲/▼ to select a different standard value.
- The “Σ” tag will blink on the LCD until the reading is stable.
- When the reading is stable and within range of the selected buffer, **CFM** functional key is displayed.

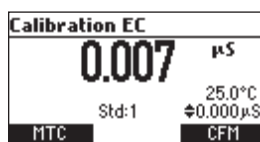

- Press **CFM** to confirm first point.
- The calibrated value and the second expected standard value is then displayed on the LCD.

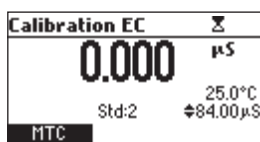

- After the first calibration point is confirmed, immerse the EC electrode into the second standard solution and stir gently. Tap the probe repeatedly to remove any air bubbles that may be trapped inside the sleeve. The instrument will automatically detect the standard after several seconds.

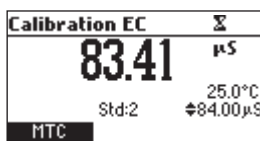

- If necessary, press the ▲/▼ keys to select a different standard value.
- The “Σ” tag will blink on the LCD.
- When the reading is stable and within range of the selected standard, the **CFM** functional key is displayed.

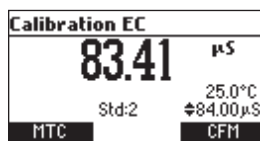

- Press **CFM** to confirm calibration.
- The calibrated value and the third expected standard value will be displayed.

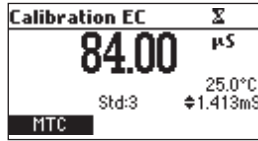

- After the second calibration point is confirmed, immerse the EC electrode into the third standard solution and stir gently. Tap the probe repeatedly to remove any air bubbles that may be trapped inside the sleeve.

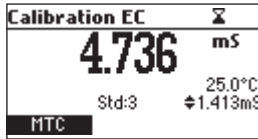

The instrument will automatically detect the standard value.

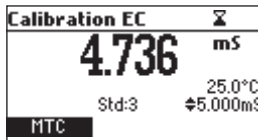

- If necessary, press the keys ▲/▼ to select a different standard value.
- The "Σ" tag will blink on the LCD until the reading is stable.
- When the reading is stable and within range of the selected standard, the **CFM** functional key is displayed.

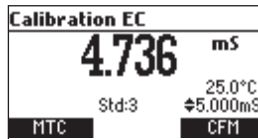

- Press **CFM** to confirm calibration.
- The calibrated value and the fourth expected standard value will be displayed.

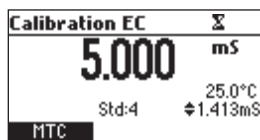

- After the third calibration point is confirmed, immerse the EC electrode into the fourth standard solution and stir gently. Tap the probe repeatedly to remove any air bubbles that may be trapped inside the sleeve.

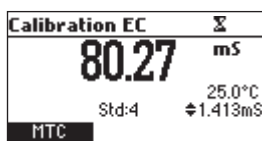

- The instrument will automatically detect the standard value.

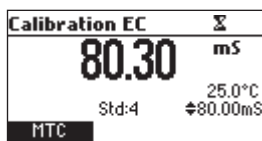

- If necessary, press the ▲/▼ keys to select a different standard value.
- The “Σ” tag will blink on the LCD until the reading is stable.
- When the reading is stable and within range of the selected standard, the CFM functional key is displayed.

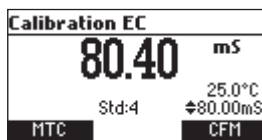

- Press CFM to confirm calibration.

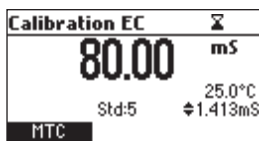

- The calibrated value and the fourth expected standard will be displayed.
- After the fourth calibration point is confirmed, immerse the EC electrode into the fifth standard solution and stir gently.

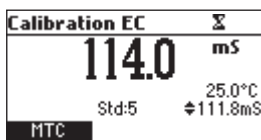

- If necessary, press the ▲/▼ keys to select a different standard value.
- The “Σ” tag will blink on the LCD until the reading is stable.
- When the reading is stable and within range of the selected standard, the **CFM** functional key is displayed.

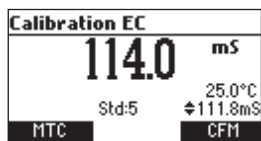

- Press **CFM** to confirm calibration.
- The instrument stores the calibration values and returns to normal measurement mode.

FOUR, THREE or TWO POINT CALIBRATION

- Proceed as described in “FIVE POINT CALIBRATION” section.
- Press **CAL** or **ESC** after the appropriate accepted calibration point. The instruments will return to measurement mode and will store the calibration data.

ERROR SCREENS

Wrong standard

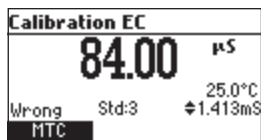

The calibration cannot be confirmed.

The EC reading is not within range of the selected standard. Select another standard using the ▲/▼ keys.

CLEAR CALIBRATION

Press **Clear** functional key when displayed to clear old calibrations.

All old calibrations will then be cleared and the instrument continues calibration. The points confirmed in current calibration are kept.

Note: If Clear calibration is invoked during the first calibration point, the instrument returns to measurement mode.

Calibration EC		Σ
49.92		μS
	Std:1	25.2°C
		±84.00μS
		Clear

REPLACE CALIBRATION STANDARD

Each time a standard is confirmed the new calibration parameters replace the old calibration parameters of the corresponding standard.

If the current standard has no correspondence in the existing stored calibration structure and this is not full, the current standard is added to the existing stored calibration (up to 5 standards).

If the existing stored calibration is full (five calibration points) after confirming the calibration point, the instrument will ask which buffer will be replaced by current standard.

Calibration EC		Σ
117.3		mS
Replace	Std:2	25.0°C
		±84.00μS
		CFM

Press **▲/▼** keys to select another standard to be replaced.

Press **CFM** to confirm the standard that will be replaced.

Press **CAL** or **ESC** to leave replace mode. In this case, the standard will not be stored.

Note: The replaced standard is not removed from calibration list and it can be selected for the next calibration points.

NaCl CALIBRATION

NaCl calibration is a one point procedure in 100.0% NaCl solution. Use the [HI7037](#) calibration solution (seawater solution) as a 100% NaCl standard solution.

- To enter NaCl calibration select the Salinity % range and press **CAL**.
- The instrument enters the Salinity calibration screen.
- Press **Salt**. The measured % NaCl, the temperature and the 100% NaCl standard are displayed.

Calibration NaCl		Σ
87.0		%
		NoTC
		±25.0°C
Std:1		100.0%

- Rinse the probe with some of the calibration solution or deionized water. Immerse the probe into [HI7037](#) solution. Tap the probe repeatedly to remove any air bubbles that may be trapped inside the sleeve.
- The “Σ” tag will blink on the LCD until the reading is stable.
- When the reading is stable, the **CFM** functional key is displayed.
Press **CFM** to confirm calibration.
- The instrument returns to measurement mode.

Calibration NaCl		Σ
87.0		%
		NoTC
		±25.0°C
Std:1		100.0%
		CFM

Notes: If the uncalibrated reading is too far from the expected value, calibration is not recognized. The “Wrong” message will be displayed.

*The meter uses 1.90%/°C temperature compensation factor during calibration. If the “Temperature Coef” in the **SETUP** menu has been set to a different value, when exiting calibration mode, the displayed value might be different from the nominal standard value.*

Calibration NaCl		Σ
12.8		%
		NoTC
		±25.0°C
Wrong	Std:1	100.0%

GLP is a set of functions that allows storage and retrieval of data regarding the maintenance and status of the electrode.

All data regarding EC and NaCl calibration is stored for the user to review when necessary.

EXPIRED CALIBRATION

The instrument is provided with a real time clock (RTC), in order to monitor the time elapsed since the last EC/NaCl calibration.

The real time clock is reset every time the instrument is calibrated and the “Expired Calibration” status is triggered when the instrument detects a calibration time out. The “CAL DUE” tag will start blinking to warn the user that the instrument should be recalibrated.

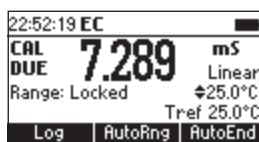

The calibration time out can be set (see SETUP for details, page 35) from 1 to 7 days or can be disabled. For example, if a 4 days time out has been selected, the instrument will issue the alarm exactly 4 days after the last calibration.

However, if at any moment the expiration value is changed (e.g. to 5 days), then the alarm will be immediately recalculated and appear 5 days after the last calibration.

Notes: When the instrument is not calibrated or calibration is cleared (default values loaded) there is no “Expired Calibration”, and the display always shows the “CAL DUE” tag blinking. When an abnormal condition in the RTC is detected, the instrument forces the “Expired Calibration” status.

LAST EC CALIBRATION DATA

The last pH calibration data is stored automatically after a successful calibration.

To view the EC calibration data, press **GLP** when the instrument is in the EC measurement mode.

The instrument will display a lot of data including calibration standards, offset, time and date, etc.

Last EC Calibration		Std
Date: 2006/03/02	→	Offset
Time: 14:58:37		80.00mS
Cal Exp: 1 day		84.00µS
TC Coef: 1.90%/°C		5.000mS
		12.88mS
More		

Use the ▲/▼ keys to select the offset or calibration standards, in order to view new information.

To see more information press **More**.

- More information regarding offset.

Std: Offset	
2006/03/02	14:50:49
Offset: 0.999µS	
T. comp: NoTC	
Tref: 25°C	

- More information regarding standards.

Std: 80.00mS	
2006/03/02	14:58:37
Cell Constant: 0.972	
T. comp: NoTC	
Tref: 25°C	

Notes: The standards that are displayed in video inverse mode are from previous calibrations. "No user calibration" message is displayed if all calibrations are cleared or the instrument was not calibrated in the EC range.

LAST NaCl % CALIBRATION DATA

Last NaCl calibration data is stored automatically after a successful calibration.

To view the NaCl calibration data, press **GLP** key while in NaCl measurement mode.

The instrument will display the NaCl information: calibration date, time and offset.

Last NaCl Calibration	
Date: 2006/03/02	
Time: 15:03:55	
Cal Exp: 1 day	
Salinity factor: 0.982	

SETUP mode allows viewing and modifying the measurement parameters.

These are general SETUP parameters for all the ranges and range specific parameters.

The following table lists the general SETUP parameters, their valid range and the factory default settings.

New	Description	Valid value	Default
Select profile	Add/View or select a profile		
Logging interval	Time for automatic logging	5, 10, 30 s 1, 2, 5, 10, 15, 30, 60, 120, 180 min	Disabled (Log on demand)
Backlight	Backlight level	0 to 7	4
Contrast	Contrast level	0 to 20	10
Auto light off	Time until backlight is ON	Disabled 1, 5, 10 min	1
Auto power off	Time after the instrument is powered OFF	Disabled 5, 10, 30, 60 min	30
Date/Time		01.01.2006 to 12.31.2099 00:00 to 23:59	current date/time
Time Format		AM/PM or 24 hours	24 hours
Date format		DD/MM/YYYY MM/DD/YYYY YYYY/MM/DD YYYY-MM-DD Mon DD, YYYY DD-Mon-YYYY YYYY-Mon-DD	YYYY/MM/DD
Language	Message display language	Up to 3 languages	English
Beep ON	Beeper Status	Enabled or Disabled	Disabled
Instrument ID	Instrument Identification	0000 to 9999	0000
Baud Rate	Serial Communication	600, 1200, 2400, 4800, 9600	9600
Meter information	Displays general information		

The following table lists the specific range parameters:

Item	Description	Valid value	Default
Calibration Timeout (EC NaCl)	Number of days after calibration warning is displayed	Disable, 1 to 7 days	Disable
Out cal range check (EC range only)	Display warning if the reading is too far from the calibration points	Enable/Disable	Disable
Temperature source	Temperature entry mode	Probe/Manual	Probe
Temperature compensation		No TC, Linear Non Linear	Linear
Range select	Fix one specific range	Automatic, Fix one resolution of EC or resistivity range	Automatic
Cell constant	Manual set of the cell constant	0.010 to 10.000	1.000
Temperature Coefficient	Set the coefficient for linear temperature compensation	0.00 to 10.00 %/°C	1.90 %/°C
Temperature Ref (°C)	Reference temperature	15 °C, 20 °C, 25 °C	25 °C
Temperature unit		°C or °F	°C
TDS factor (TDS range only)		0.40 to 1.00	0.50

GENERAL PARAMETER SCREENS

Select Profile

Highlight *Select Profile*.



Press **Select**.

The list with stored profiles is displayed.

Select Profile	
1	2006/01/01 01:14:36
2	2006/01/01 15:49:37
3	2006/01/01 15:50:29
4	2006/01/03 09:05:54
Select	View Add

Press **Add** to add a new profile to the list (max 10).

Use the **▲/▼** keys to highlight the desired profile.

Press **Select** to choose the profile and exit to SETUP.

Profile 4 [EC]	
2006/01/04	10:33:38
CAL: Salt, EC	KCell: 1.000
T: 25°C, NoTC, 1.90, Manual	
Fixed Range: None	
Delete	GLP NaCl GLP EC

Press **View** to view profile information.

The profile information includes the date and the time when the profile was added, information about calibration on EC and NaCl range, the setup cell constant, information about temperature setting, reference temperature, temperature compensation mode, temperature coefficient, temperature source and information about fixed ranges.

If calibration exists, the **GLP** functional key is displayed. Press **GLP EC** to view the corresponding GLP EC information.

Press **GLP NaCl** to view the corresponding GLP NaCl information.

Note: If the EC or NaCl calibration was not performed while the current profile is set, or calibration was cleared, the corresponding GLP key is not displayed.

Press **Delete** to delete selected profile. The **Delete** key is displayed only if more than one profile is in the list.



Press **Accept** to confirm the deletion or **Cancel** to cancel and return to the previous screen.

Press **ESC** to return to profile list screen.

Logging Interval

Highlight *Logging interval*.

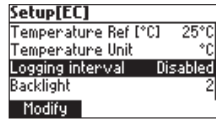

Press **Modify**.

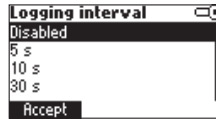

Use the **▲/▼** keys to select the logging interval. If "**Disabled**" action is selected, the **Autolog** feature is disabled and **Log on demand** is enabled.

Press **Accept** to confirm the value.

Press **ESC** to exit without saving.

Backlight

Highlight *Backlight*.

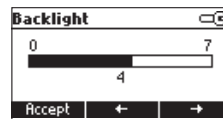
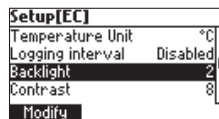

Contrast

Highlight *Contrast*.



Press **Modify**.

Use ← / → keys to change contrast then press **Accept** to confirm.

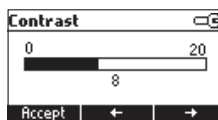

Press **ESC** to leave without changing.

Auto Light Off

Highlight *Auto Light Off*.



Press 5, 10 or Disabled to change settings.

Press one of the functional keys to change the option.

Auto Power Off

Highlight *Auto Power Off*.

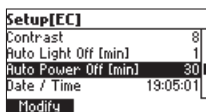

Press **Modify**.

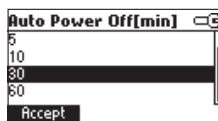

Press ▲/▼ keys to select internal interval then press **Accept**.

Press **ESC** to leave without changing.

Date/Time

Highlight *Date/Time*.

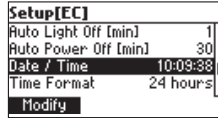

Press **Modify**.

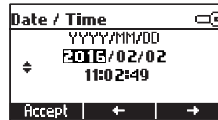

Use ← / → keys to select item. Use ▲/▼ keys to change focused values.

Press **Accept** to confirm new setting, or **ESC** to leave without changing.

Time Format

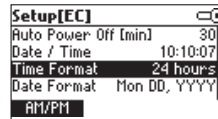

Highlight *Time Format*.

Press functional key to change the option.

Date Format

Highlight *Date Format*.

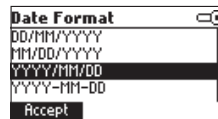
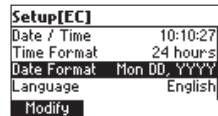

Language

Highlight *Language*.

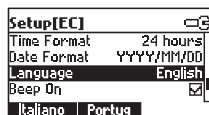

Use the desired functional key to change the option. Wait until new language is loaded.

If any language can be loaded, the instrument will work in safe mode. In this mode all messages are displayed in English and **Help** is not available.

Beep On

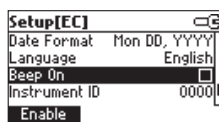

Highlight *Beep On*.

Press the displayed functional key to enable/disable key.

When enabled, beep sounds as a short beep every time a key is pressed or when the calibration icon can be confirmed.

A long beep alert that the pressed key is not active or a wrong condition is detected while in calibration.

Instrument ID

Highlight *Instrument ID*.

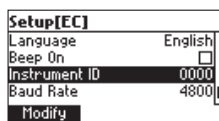

Press **Modify**.

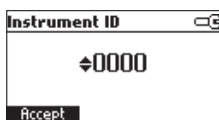

Use ▲/▼ keys to change the instrument ID.

Press **Accept** to confirm or **ESC** to exit without saving.

Baud Rate

Highlight *Baud Rate*.

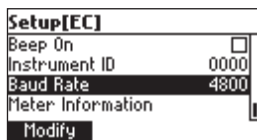

Press **Modify**.

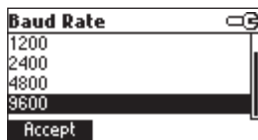

Use **▲/▼** keys to select the desired communication baud. Press **Accept** to confirm or **ESC** to exit.

Meter information

Highlight *Meter Information*.

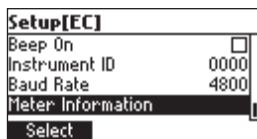

Press **Select**.

The meter information is displayed:

- Firmware version
- Language version
- mV and temperature factory calibration time/date
- Battery capacity

HI98192 Meter Info	
Firmware	V1.2
Language	2.6
EC	2016/01/27 16:13:04
T	2016/01/27 16:08:08
Battery Capacity	79%

RANGE SPECIFIC PARAMETERS

Calibration Timeout

Highlight *Calibration Timeout*.



Press **Modify**.

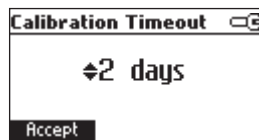
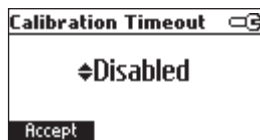

Use **▲/▼** keys to set desired value.

Press **Accept** to confirm or **ESC** to return without saving.

Note: If enabled "CAL DUE" warning will be displayed, the set number of days after calibration is over passed.

Out of calibration range check

Highlight *Out of cal range check*.

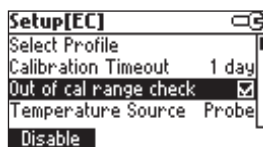

Press the corresponding functional key in order to enable/disable this feature. If enabled, a warning message is displayed when the EC reading is too far from the EC calibration points.

Temperature Source

Highlight *Temperature Source*.

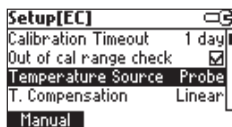

Press the displayed functional key in order to change the option.

Select **Probe** in order to take the temperature automatically with the temperature sensor inside the electrode.

Select **Manual** in order to set the temperature using the ▲/▼ keys.

Temperature Compensation

Highlight *T. Compensation*.

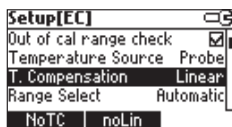

Press one of the selected functional keys to change the option.

Select **No TC** in order to display actual conductivity (no temperature compensation).

Select **Linear** in order to automatically compensate conductivity using the set temperature coefficient.

Select **Non Linear** temperature compensation for natural water measurements, using the natural water compensation equation.

Range Select

Highlight *Range Select*.

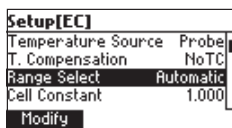

Press **Modify** to select ranging mode.

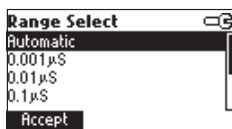

Use the ▲/▼ keys to change selection.

Press **Accept** to confirm or **ESC** to exit without saving. If **Automatic** is selected the instrument changes the range automatically according with the input.

If one of the range is selected all the readings are displayed on the corresponding range.

The readings will be displayed with maximum 6 digits. If the reading exceeds the maximum number of digits for the fixed range, the maximum value is displayed blinking.

Note: The Range select parameter can be set only in EC and Resistivity range.

Cell Constant

Highlight *Cell Constant*.

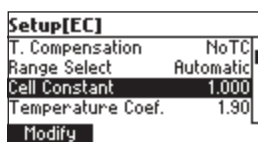

Press **Modify** to change the cell constant value.

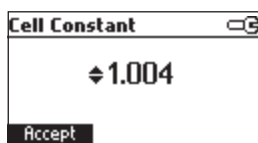

Use ▲/▼ keys to change the cell constant value.

Press **Accept** to confirm or **ESC** to exit without changing.

Temperature Coefficient

Highlight *Temperature Coef.*.

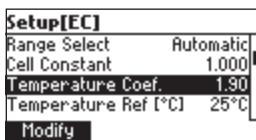

Press **Modify** in order to set the temperature coefficient.

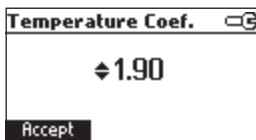

Use the ▲/▼ keys to change the value.

Press **Accept** to confirm or **ESC** to exit without changing.

Temperature Reference

Highlight *Temperature Ref [°C]*.

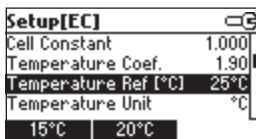

Press the corresponding functional key to select the desired reference temperature.

Temperature Unit

Highlight *Temperature Unit*.

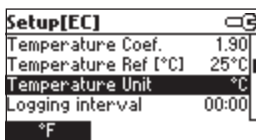

Press the displayed functional key in order to change the temperature unit.

This feature allows the user to log up to 400 readings. All logged data can be transferred to a PC through the **USB** port using **HI92000** application.

LOGGING THE CURRENT DATA

To store the current reading into memory, press **LOG** while in measurement mode.

The instrument will display the record number and the amount of free log space for several seconds after the **LOG** option is selected.

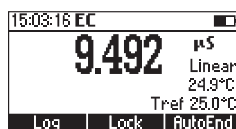

If the log space is full, the “**Log space is full**” message will be displayed for few seconds when **Log** key is invoked.

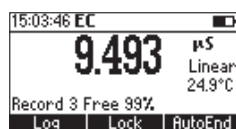

Enter **View Logged Data** mode and delete records in order to free log space.

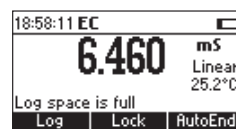

VIEW LOG ON DEMAND DATA

Press **RCL** to enter **View Logged Data** mode.

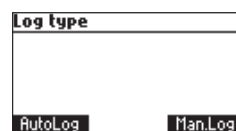

Press **Man.Log** to enter the log on demand range selection.

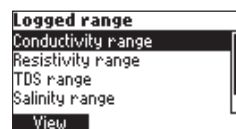

Use ▲/▼ keys to highlight the desired range then press **View**.
The list of records corresponding to the selected range is displayed.

	EC	Date
1	64.66 μ S	2006/03/02
2	74.36 μ S	2006/03/02

Delete All | Delete | More

If no data were logged on the current range, the instrument will display “No Records” message.

Use ▲/▼ keys to scroll between the records from the list.

Press **Delete All** to enter *Delete All* screen.

Press **Delete** to enter *Delete records* screen.

Press **More** to view more information of the selected record.

Record number: 1	
2006/03/02	17:02:02
EC: 64.66 μ S	25.0°C
T Src/Comp:	Tref: 25.0°C
	Manual/NoTC

Pg Down

If **More** is pressed:

Use **Pg Up** or **Pg Down** keys to toggle the complete information screens.

Use ▲/▼ keys to scroll between stored records.

If **Delete** is pressed:

Delete Record?		
1	6.06	2006/01/18
2	6.06	2006/01/18
3	6.06	2006/01/18
4	6.06	2006/01/18

CFM

Use ▲/▼ key to select the record to be deleted and then press **CFM**.

Press **ESC** to exit.

If **Delete All** is pressed the instrument asks for confirmation.

Press **CFM** to confirm or **ESC** to exit without deleting.

For **USP range**, the instrument will display the sample ID, analysis time and date:

	EC	Date
1	64.66 μ S	2006/03/02
2	74.36 μ S	2006/03/02

Delete All | Delete | More

Use ▲/▼ keys to select the desired record.

Press **Delete** to enter delete one record mode.

Press **Delete All** to enter delete all mode.

Press **More** to view the complete record information.

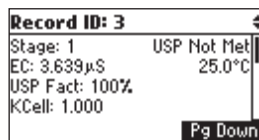

Press **Pg Down** or **Pg Up** to scroll the record screens.

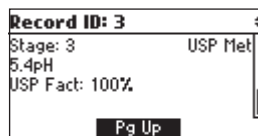
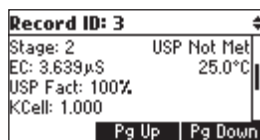

This feature allows the user to log up to 1000 readings.

All logged data can be transferred to PC through USB port.

The memory space is organized in lots of records. A lot can contain from 1 to 1000 records. The maximum available lots number is 100.

START AUTOLOG

Set the desired logging interval in the **Setup** menu.

If **5, 10, 30 s** or **1 min** interval is selected, the **Auto Power Off** feature is disabled (each sample stored restarts the Auto Power off counter). For other intervals, the instrument will enter a sleeping mode. During this mode the instrument continues to monitor the inputs and memorize the reading at the set interval. To exit sleeping mode, simply press any key (exception **ON/OFF**).

Note: While in sleeping mode the instrument cannot be powered off by pressing ON/OFF key. Leave sleeping mode and then press ON/OFF key to power off the instrument.

To start autolog from the measurement screen press **StartLog** key. The lot number and the amount of memory space is displayed for several seconds.

If the autolog space is full or the lots number exceeds 100 the “**Auto log space full**” message is displayed.



VIEW AUTOLOG DATA

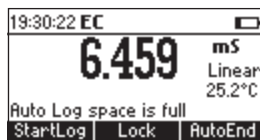

Press **RCL** key to enter **View Logged Data** mode.



Press **AutoLog** to enter the automatic log range selection.

Logged range
Conductivity range
Resistivity range
TDS range
Salinity range
View

Use **▲/▼** keys to highlight the desired range, then press **View**.

The list of lots corresponding to the selected range is displayed.

Lot	Time	Date
1	17:03:32	2006/03/02
2	19:06:18	2006/03/02
3	19:06:51	2006/03/02
Delete All Delete More		

If no data were logged on the current range, the instruments will display “**No Records!**”.

Use **▲/▼** keys to scroll the lot list. Press **Delete** or **Delete All** to delete one or all of the lots. The confirmation is asked as at individual records are deleted.

Press **More** to view more information.

	EC	Time
1	64.66 μ S	17:03:32
2	64.66 μ S	17:03:37
3	64.66 μ S	17:03:42
4	64.66 μ S	17:03:47
More		

The list of records for the specific lot is displayed.

Press **More** to view the complete record information.

Record number: 1	
2006/03/02	17:02:02
EC: 64.66 μ S	25.0°C
	Tref: 25.0°C
T Src/Comp:	Manual/NoTC
Pg Down	

Press **Pg Down** or **Pg Up** to scroll the information screens.

To freeze the first stable reading on the LCD press **AutoEnd** while the instrument is in measurement mode.



The "Wait" symbol will blink until the reading is stable.

When the reading is stable, "Hold" icon will be displayed.

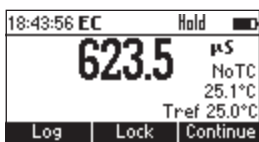

Press **Continue** in order to enter continuous reading mode.

All the instruments are factory calibrated for temperature.

Hanna's temperature probes are interchangeable and no temperature calibration is needed when they are replaced.

If the temperature measurements are inaccurate, temperature recalibration should be performed.

For an accurate recalibration, contact your dealer or the nearest Hanna Customer Service Center, or follow the instructions below.

Press "T" functional key to enter the temperature calibration mode while in **EC** or **Salinity** calibration screens.

It is better to perform a 2 point calibration.

The calibration can be performed in any two points that have at least 25 °C distance between. It is recommended that the first point be near 0 °C and the second point near 50 °C.

- Prepare a vessel containing ice and water and another one containing hot water (at approximately 50 °C or 122 °F). Place insulation material around the vessels to minimize temperature changes.
- Use a calibrated thermometer with a resolution of 0.1 °C as a reference thermometer. Connect the [HI763133](#) EC probe with built in temperature sensor to the appropriate socket.
- Immerse the [HI763133](#) probe into the vessel with ice and water as close as possible to the reference thermometer. Allow a few seconds for the probe to stabilize.

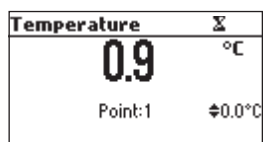

- Use the ▲/▼ keys to set the calibration point value to that of ice and water mixture, measured by the reference thermometer. Set the calibration point value to that measured in the reference thermometer.

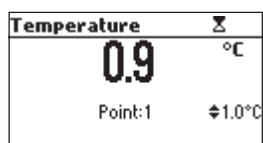

- When the reading is stable and within range of the selected calibration point, the CFM functional key is displayed.

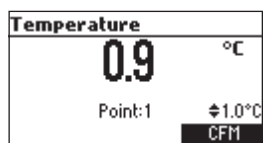

- Press **CFM** to confirm.
- The second expected calibrated point is displayed.

Temperature		Σ
1.0		°C
Point:2		±50.0°C

- Immerse the probe into the second vessel as close as possible to the reference thermometer. Allow a few seconds for the probe to stabilize.

Temperature		Σ
25.1		°C
Point:2		±50.0°C

- Use the ▲/▼ keys to set the calibration point value to that measured by the reference thermometer.

Temperature		Σ
25.1		°C
Point:2		±26.0°C

- When the reading is stable and within range of the selected calibration point, **CFM** functional key is displayed.

Temperature		Σ
25.1		°C
Point:2		±26.0°C
		CFM

- Press **CFM** to confirm. The instrument returns to measurement mode.

Note: If the reading is not within range of the selected calibration point or the difference between first selected point and second selected point is less than 25 °C, "Wrong" message will blink.

Temperature		
25.1		°C
Wrong	Point:2	±25.0°C

If the Wrong source is the difference between calibration points increase the temperature of the vessel with hot water.

If the Wrong source is the temperature reading change the probe and restart calibration.

If calibration cannot be performed contact Hanna Service.

For one point calibration press ESC after first point was confirmed.

Data transmission from the instrument to the PC can be done with the **HI92000** Windows® compatible software (optional). **HI92000** also offers graphing and on-line help feature.

Data can be exported to the most popular spreadsheet programs for further analysis.

To connect your instrument to a PC, use an **USB** cable connector. Make sure that your instrument is switched off and plug one connector to the instrument **USB** socket and the other to the serial or USB port of your PC.

Note: If you are not using Hanna Instruments HI92000 software, please see the following instructions.

SENDING COMMANDS FROM PC

It is also possible to remotely control the instrument with any terminal program. Use an **USB** cable in accordance with the model to connect the instrument to a PC, start the terminal program and set the communication options as follows: 8, N, 1, no flow control.

COMMAND TYPES

To send a command to the instrument follow the next scheme:

< command prefix > < command > < CR >

where: < command prefix > is a selectable 16 ASCII character

< command > is the command code.

Note: Either lowercase or capital letters can be used.

SIMPLE COMMANDS

KF1	Is equivalent to pressing functional key 1
KF2	Is equivalent to pressing functional key 2
KF3	Is equivalent to pressing functional key 3
RNG	Is equivalent to pressing RANGE
MOD	Is equivalent to pressing MODE
CAL	Is equivalent to pressing CAL
UPC	Is equivalent to pressing the UP arrow key
DWC	Is equivalent to pressing the DOWN arrow key
RCL	Is equivalent to pressing RCL
SET	Is equivalent to pressing SETUP
CLR	Is equivalent to pressing CLR
OFF	Is equivalent to pressing OFF

CHR xx Change the instrument range according with the parameter value (xx):

- xx= 10 EC range
- xx= 11 Resistivity range
- xx= 12 TDS range
- xx= 13 USP range
- xx= 14 NaCl % range
- xx= 15 Salinity, Seawater range
- xx= 16 Salinity, PSU range

The instrument will answer for these commands with:

<STX> <answer> <ETX>

where: <STX> is 02 ASCII code character (start of text)

<ETX> is 03 ASCII code character (end of text)

<answer>:

<ACK> is 06 ASCII code character (recognized command)

<NAK> is 21 ASCII code character (unrecognized command)

<CAN> is 24 ASCII code character (corrupted command)

COMMANDS REQUIRING AN ANSWER

The instrument will answer for these commands with:

<STX> <answer> <checksum> <ETX>

where the checksum is the bytes sum of the answer string sent as 2 ASCII characters.

All the answer messages are with ASCII characters.

RAS Causes the instrument to send a complete set of readings in according with the current range:

- EC and temperature readings or EC range.
- Resistivity, EC and temperature readings on Resistivity
- TDS, EC and temperature readings on TDS range
- Salinity, EC, and temperature or Salinity range.

The answer string contains:

- Meter mode (2 chars):
- xx= 10 EC range
- xx= 11 Resistivity range
- xx= 12 TDS range
- xx= 13 USP range
- xx= 14 NaCl % range

- xx= 15 Salinity, Seawater range
 - xx= 16 Salinity, PSU range
 - Meter status (2 chars of status byte): represents a 8 bit hexadecimal encoding.
 - 0x10 - temperature probe is connected
 - 0x20 - autolog in progress
 - 0x01 - new GLP data available
 - 0x02 - new SETUP parameter
 - 0x04 - out of calibration range
 - 0x08 - the meter is in autoend point mode
 - 0x30 - the instrument is in fixed range
 - Reading status (2 chars): R - in range, O - over range, U - under range. First character corresponds to the primary reading. Second character corresponds secondary reading.
 - Primary reading (corresponding to the selected range) - 10 ASCII chars, including sign, decimal point and unit.
 - Secondary reading (only when primary reading is not EC) - 10 ASCII chars, including sign, decimal point and unit (if primary reading is not conductivity).
 - Temperature reading - 8 ASCII chars, with sign, decimal point, always in °C.

MDR

Requests the instrument model name and firmware code (16 ASCII chars).

GLPxx

Requests the calibration data record for “xx” profile number.

The answer string contains:

- GLP status (1 char): represents a 4 bit hexadecimal encoding.
 - 0x01 - EC calibration available
 - 0x02 - NaCl calibration available
- EC calibration data (if available), which contains:
 - calibration time (12 chars)
 - the number of calibration point (1 char)

For each calibration point:

 - the standard value (10 chars)
 - offset factor or cell constant (with sign and decimal point)
 - time when was calibrated (12 chars)
 - salinity calibration
 - calibration time (12 chars)
 - salinity coefficient (10 chars)

PRFxx Request profile “xx” information

The answer string contains:

- 10 - EC range
- 11 - Resistivity range
- 12 - TDS range
- 13 - USP range
- 14 - NaCl % range
- 15 - Salinity, Seawater range
- 16 - Salinity, Seawater PSU range
- Creation time (12 chars)
- Temperature source (1 char): 0 - probe, 1 - manual entry
- Temperature compensation: 0 - NOTC, 1 - linear TC, 2 - non linear TC
- Beep status (1 char): 0 - off, 1 - on
- Temperature unit (1 char): 0 - °C, 1 - °F
- Backlight (2 chars)
- Contrast (2 chars)
- Auto light off (3 chars)
- Auto power off (3 chars)
- Baud rate (5 chars)
- Instrument ID (4 chars)
- EC alarm time out interval (2 chars)
- NaCl alarm time out interval (2 chars)
- Logging interval (5 chars)
- Calibration range check (1 char): 0 - off; 1 - on
- TDS factor (6 chars)
- Temperature coefficient (6 chars)
- Reference temperature (6 chars)
- Cable correction resistor (5 chars)
- Cable correction capacitance (4 chars)
- EC fixed range number (1 char)
- Resistivity fixed range number (1 char)
- TDS fixed range number (1 char)
- Language ID (3 chars)
- Cell Constant (7 chars)

- PAR** Requests the setup parameters setting.
The answer string contains:
- Number of profiles (2 chars)
 - Current profile ID (2 chars)
 - Number of languages (2 chars)
- NSLx** Requests the number of logged samples.
The command parameter (1 char):
- E - the request is for EC range
 - R - the request is for Resistivity range
 - T - the request is for TDS range
 - N - the requests is for NaCl range
 - U - the requests is for USP range
- The answer string is the number of samples (4 chars)
- ULS** Requests information about the status of the USP log reports.
The answer string contains:
- The number of reports (3 chars)
- For every USP report the following information are sent:
- Report ID (3 chars)
 - Log time (12 chars)
- LLS** Requests information about the number of lots
The answer string contains:
- The number of lots (3 chars)
- For every lot the following information are sent:
- Lot ID (3 chars)
 - Log time (12 chars)
 - Lot type (1 char): 0 - EC; 1 - Resistivity; 2 - TDS; 3 - NaCl
- GLDxxx** Requests all the records for the lot with ID = xxx
The answer string contains:
Lot header data:
- Logging interval (1 s) (5 chars)
 - Temperature source (1 char)
 - Temperature compensation mode (1 char)
 - Reference temperature (2 chars)

- Temperature coefficient (6 chars)
- Offset factor (6 chars)
- TDS factor (6 chars) (only for TDS lots)
- Salinity coefficient (7 chars) (only for salinity lots)
- Profile ID (4 chars)
- Profile creation time (12 chars)
- Lot start time (12 chars)

Lot record data:

- EC value (8 chars)
- EC unit (1 char): 0 - μ S; 1 - mS
- EC over range flag (1 char): R, U, 0
- Temperature reading, in $^{\circ}$ C (8 chars)

Next data is sent if the lot is not for EC range.

- Resistivity or TDS or Salinity (8 chars)
- Reading unit:
 - Over range flag (1 char)
 - Resistivity: 0 - ohm; 1 - Kohm; 2 - Mohm
 - TDS: 0 - ppm; 1 - g/L
 - Salinity: 0 - %; 1 - ppt; 2 - PSU

LODxxx Requests the log information for record number "xxx" on range "r"

- "r" is E for EC, R for resistivity, T for TDS and N for salinity

The answering string contains:

- The logged range (2 chars): 10 - EC, 11 - Resistivity, 12 - TDS, 13 - USP, 14 - NaCl %, 15 - Salinity Seawater, 16 - Salinity PSU

For EC, Resistivity, TDS and salinity ranges:

- EC reading (8 chars)
- EC unit (1 char)
- Temperature source (1 char)
- Temperature compensation mode (1 char)
- Reference temperature (2 chars)
- Temperature coefficient (6 chars)
- Cell Constant (7 chars)
- The nearest calibration standard (7 chars)

- The calibration standard unit (1 char)
- Offset factor (6 chars)
- Temperature reading (8 chars)
- Resistivity or TDS or salinity reading (8 chars)
- Unit (1 char)
- TDS factor (6 chars) or salinity coefficient (7 chars)
- Log time (12 chars)

For USP records:

- Record ID (3 chars)
- Stage 1 status (1 char): 0 - not verified; 1 - USP met; 2 - USP not met
- Stage 2 status (1 char): see Stage 1
- Stage 3 status (1 char): see Stage 1
- Stage 1 data (if exist):
 - EC reading (8 chars)
 - EC unit (1 char)
 - Temperature reading in °C
- Stage 2 data (if exists) - same as Stage 1
- Stage 3 data (if exists)
 - pH value (5 chars)
- USP factor (3 chars)
- Cell Constant (1 char)

Note: "Err3" is sent if record does not exist

"Err4" is sent if the identification range character is not recognized

"Err5" is sent if autolog is in progress

"Err6" is sent if the request range is not available

"Err7" is sent if the instrument is logging

"Err8" is sent if the instrument is not in the measuring mode

"Err9" is sent if the battery low condition is detected and the communication cannot be done

To replace the batteries, follow the next steps:

- Turn OFF the instrument.
- Open the battery compartment by removing the four screws from the back of the instrument.
- Remove the old batteries.
- Insert four new 1.5V AA batteries in the battery compartment while paying attention to the correct polarity.
- Close the battery compartment using the four screws.

If the battery capacity is less than 20% the serial communication and the backlight feature are not available.

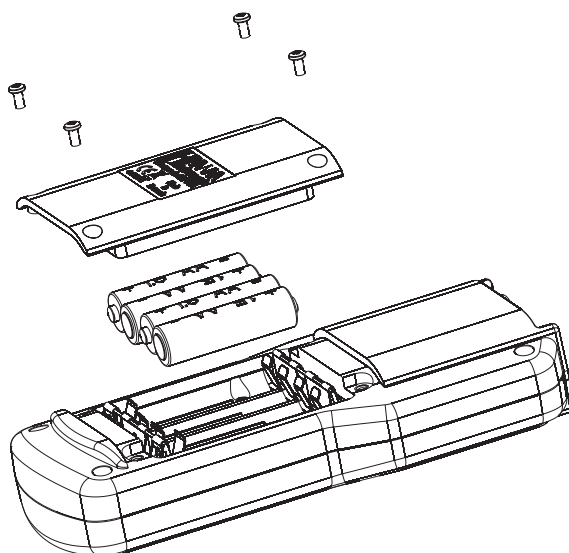

Note: The instrument is provided with the BEPS (Battery Error Prevention System) feature, which automatically turns the instrument off when the battery level is too low to ensure reliable readings.

SYMPTOMS	PROBLEM	SOLUTION
Reading fluctuates up and down (noise).	EC probe not properly connected.	Ensure the probe is connected to the meter. Check that the probe is immersed in your sample.
Display shows the top of the range reading blinking.	Reading out of range.	Recalibrate the meter; Check the sample is within the measurable range. Check the range is not fixed or locked.
Meter fails to calibrate or gives faulty readings.	Broken EC probe.	Replace the probe.
At startup the meter displays Hanna Logo tags permanently.	One of the keys is blocked.	Contact your dealer at any Hanna Instruments Service Center.
Meter shuts off.	Dead accumulators, Auto Power Off feature is enabled: in this case, meter shuts off after selected period of non use.	Recharge accumulators or replace accumulator. Press ON/OFF .
"Error" message at start up.	Internal error.	Contact your dealer at any Hanna Instruments Service Center.
The instrument does not start when pressing ON/OFF .	Initialization error.	Press and hold down ON/OFF for about 20 sec. or disconnect and then connect one accumulator.

Rinse the probe with clean water after measurements. If more cleaning is required, remove the probe sleeve and clean the probe with a cloth or a nonabrasive detergent. Make sure to reinsert the sleeve onto the probe properly and in the right direction. After cleaning the probe, recalibrate the instrument. The platinum rings are sustained with glass. Take great care while handling the probe.

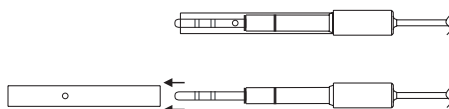

REPLATINIZATION

The coating of platinum black on the electrodes of the conductivity cell should be inspected before and after use for signs of flaking or loss of material. If the coating seems poor, cleaning and replatinization is required.

To perform probe replatinization, enter calibration screen from EC range by pressing **CAL** key.

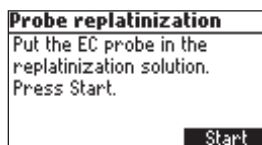
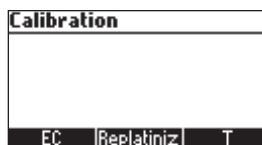

Put the probe into a beaker with replatinization solution and press **Start**.



The process can be interrupted by pressing **Stop** or **ESC** key.

The replatinization process takes about 5 minutes.



Remove the probe from the replatinization solution and rinse it with deionized water.

Code	Description
HI70031C	1413 $\mu\text{S}/\text{cm}$, 20 ml sachet, 25 pcs.
HI70039C	5000 $\mu\text{S}/\text{cm}$, 20 ml sachet, 25 pcs.
HI70030C	12880 $\mu\text{S}/\text{cm}$, 20 ml sachet, 25 pcs.
HI6033	84 $\mu\text{S}/\text{cm}$, 500 ml bottle
HI6031	1413 $\mu\text{S}/\text{cm}$, 500 ml bottle
HI7039L	5000 $\mu\text{S}/\text{cm}$, 500 ml bottle
HI7030L	12880 $\mu\text{S}/\text{cm}$, 500 ml bottle
HI7034L	80000 $\mu\text{S}/\text{cm}$, 500 ml bottle
HI7035L	111800 $\mu\text{S}/\text{cm}$, 500 ml bottle
HI7037L	100% NaCl, 500 ml bottle
HI763123	Platinum four-ring conductivity/TDS probe with internal temperature sensor and 1 m (3.3') cable
HI763133	Four-ring conductivity/TDS probe with internal temperature sensor and 1.5 m (4.9') cable
HI92000	Windows® compatible software application
HI920015	Micro USB cable

Recommendations for Users

Before using Hanna products, make sure that they are entirely suitable for your specific application and for the environment in which they are used. Operation of these instruments may cause unacceptable interferences to other electronic equipment. Take all necessary steps to correct such interferences.

During operation, ESD wrist straps should be worn to avoid possible damage to the electrode by electrostatic discharges.

Any variation introduced by the user to the supplied equipment may degrade the instruments' EMC performance.

To avoid electrical shock, do not use these instruments when voltages at the measurement surface exceed 24 Vac or 60 Vdc.

To avoid damage or burns, do not perform any measurement in microwave ovens.

Warranty

The HI98192 is warranted for two years against defects in workmanship and materials when used for their intended purpose and maintained according to instructions. Electrodes and probes are warranted for six months. This warranty is limited to repair or replacement free of charge.

Damage due to accidents, misuse, tampering or lack of prescribed maintenance is not covered.

If service is required, contact the dealer from whom you purchased the instrument. If under warranty, report the model number, date of purchase, serial number and the nature of the problem. If the repair is not covered by the warranty, you will be notified of the charges incurred. If the instrument is to be returned to Hanna Instruments, first obtain a Returned Goods Authorization (RGA) number from the Technical Service department and then send it with shipping costs prepaid. When shipping any instrument, make sure it is properly packed for complete protection.

Hanna Instruments reserves the right to modify the design, construction or appearance of its products without advance notice.

World Headquarters

Hanna Instruments Inc.
Highland Industrial Park
584 Park East Drive
Woonsocket, RI 02895 USA
www.hannainst.com

Local Office

Hanna Instruments USA
270 George Washington Highway
Smithfield, RI 02917
Phone: 800.426.6287
Fax: 401.765.7575
e-mail: tech@hannainst.com



MAN98192 03/16

Printed in ROMANIA